

# **FBI** FRIED BROTHERS, INC.

ESTABLISHED 1922

SUPPLIER OF DOOR HARDWARE, SECURITY PRODUCTS, AND ACCESS CONTROL



[FBIsecurity.com](http://FBIsecurity.com)

## Wholesale Distributor

**Commercial/Institutional Door Hardware**

**Access Control**

**School Lockdown Security**

**Metal Detector**

**OSHA Safety**

**Washroom Accessories**

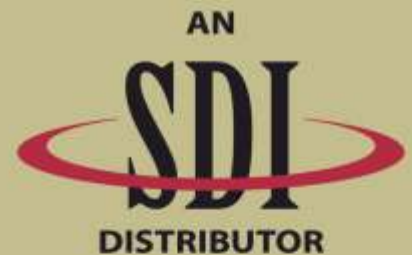

**GSA Contract :** GS-07F-0249Y

**GSA Contract :** GS-07F-0326T

**DUNS NO :** 001949684

**CAGE CODE :** 40786

**Phone :** 215-627-3205

**Email :** [sales@fbisecurity.com](mailto:sales@fbisecurity.com)

# LOCINOX

Let's make it better together

## Locinox Gate & Fence Locks & Hardware



**EASY & RELIABLE SOLUTIONS  
FOR CHAIN LINK ACCESS GATES**



**SAFE & QUALITY SOLUTIONS FOR  
INDUSTRIAL GRADE CHAIN LINK GATES**



**RELIABLE AND DURABLE SOLUTIONS  
FOR DOG PARK GATES**



**WALK GATE FOR RESIDENTIAL OR  
COMMERCIAL APPLICATIONS**



**A SAFE AND CHILDPROOF  
SWIMMING POOL AREA**



**THE COMPLETE CHAIN LINK  
CONCEPT GATE FOR ALL USES**





# KEEP THAT DOOR OPEN.



## HEAVY DUTY DOOR STOPPER!

*Works In A Snap! Magnetized For Convenient Storage!  
Easy As 1~2~3 To Hold Open A Door With Fativan!*

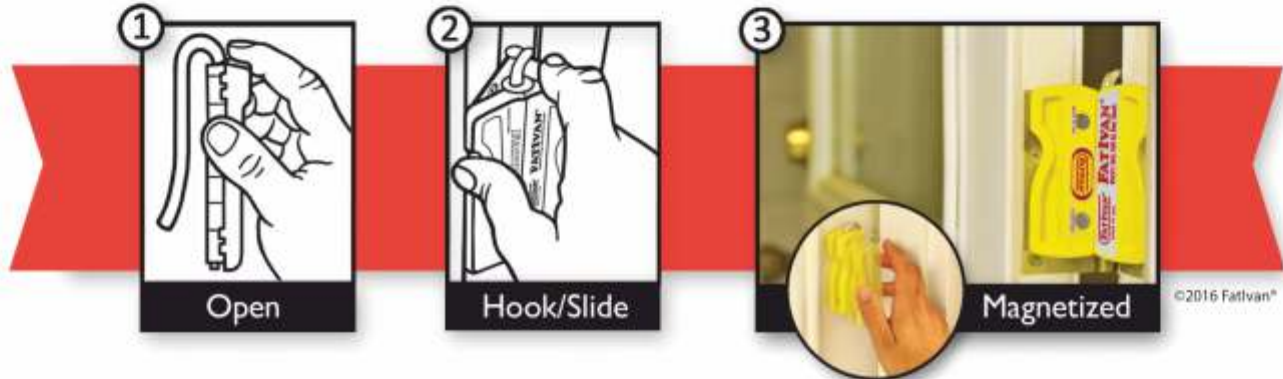

EMERGENCY SERVICES • COMMERCIAL • INDUSTRIAL • RESIDENTIAL • DELIVERIES



**857670003035 - The Original Fativan® with Magnet - Red**



**857670003011 - The Original Fativan® with Magnet - Yellow**



**857670003080 - The Original Fativan® with Magnet - Green**

**MANUFACTURERS**

A-1 SECURITY MFG (AF) ..... 1  
 ABUS LOCK CO (AU).....5  
 ADAMS RITE (AR).....7  
 ADVANCED DIAGNOSTICS (AV) 17  
 ALARM CONTROLS (AC) ..... 18  
 ALARM LOCK (AL)..... 23  
 AMERICAN LOCK CO (AM)..... 26  
 AMSEC (AS)..... 30  
 ARROW LOCK (AW)..... 31  
 ASSA HIGH SECURITY (AI) ..... 35  
 AUTO SECURITY PRODUCTS (AP) 38  
 BALLISTOL (BA) ..... 40  
 BAUER PRODUCTS (BP).....40  
 BEST (BE)..... 41  
 BOMMER INDUSTRIES (BO) ..... 44  
 C.L.S., INC (CL)..... 45  
 CANSEC (CN) ..... 46  
 CCL (CR)..... 49  
 COMMAND ACCESS (CA) ..... 52  
**COMPX SECURITY PRODUCTS**  
 CH.....CHICAGO LOCK ..... 54  
 CE.....E-LOCK ..... 58  
 FL.....FORT LOCK..... 60  
 NL.....NAT'L CABINET LOCK..... 64  
 TM.....TIMBERLINE LOCK..... 73  
 CORBIN RUSSWIN (RW) ..... 75  
 DETEX (DX)..... 79  
 DISPENSER KEYS (DK) ..... 83  
 DON-JO (DJ)..... 84  
 DOOR GUARDIAN (DG) ..... 97  
 DOOR SCOPE (DS) ..... 97  
 ENTREMATIC (EN) ..... 97  
 ESP (ES)..... 99

**FALCON BRANDS (FA) (DR) (MN)\***  
**FALCON** ..... 100  
 \*INCLUDES DOR-O-MATIC & MONARCH PRODUCTS  
 FOLGER ADAM (FG)..... 106  
 FRONTLINE DEFENSE (FD) ..... 107  
 GMS (GM)..... 108  
 HATA (HA) ..... 115  
 HES (HANCHETT) (HE)..... 116  
 HINGE DOCTOR (HD) ..... 122  
 HOUNDINI (HO)..... 122  
 HPC (HP)..... 123  
 IEI (IE)..... 131  
 ILCO (IL)..... 132  
 INT'L DOOR CLOSERS (IT)..... 140  
 IVES (IV)..... 141  
 JET HARDWARE (JT)..... 143  
 JMA (JM)..... 145  
 KABA ACCESS (KA)..... 147  
 KABA MAS (KM)..... 155  
 KEEDEX (KE) ..... 157  
 KERI SYSTEMS (KR)..... 159  
 KEYSKAN ..... 161  
 KEY SYSTEMS (KI)..... 164  
 KIDDE (GE)..... 165  
 KSP (KILLEEN) (KP) ..... 167  
 KWIKSET (KS) ..... 169  
 LAB SECURITY (LA)..... 172  
 LATCH-GARD (LG) ..... 179  
 LCN CLOSERS (LC)..... 180  
 LOCKNETICS (LN)..... 188  
 LOCK-SAVER (LS) ..... 179  
 LUCKY LINE (LL)..... 190

MAJOR MFG (MM) ..... 198  
 MARKAR PRODUCTS (MK) .....207  
 MASTER LOCK (ML)..... 208  
 MCKINNEY (MC)..... 228  
 MEDECO (MD) ..... 229  
 MEGA PRO TOOLS (MP) ..... 239  
 MS SEDCO (MS)..... 240  
 NICHOLSON TOOLS (NI) ..... 240  
 NORTON DOOR CLOSER (NO).....241  
 OLYMPUS LOCK (OL) ..... 247  
 OPTEX (OX) ..... 251  
 PEMCO (PE) ..... 252  
 PRECISION HARDWARE (PH).....256  
 PRO-LOK (PL)..... 267  
 RCI (RC) ..... 272  
 RYTAN (RY)..... 276  
 SANDSTROM PRODUCTS (PX)..... 276  
 SARGENT & GREENLEAF (SG) ...277  
 SARGENT (SA) ..... 281  
 SCHLAGE (SC) ..... 286  
 SECURITRON (SE)..... 308  
 SELECT HINGES (SH)..... 316  
 SRS PRODUCTS (SR)..... 317  
 STRATTEC (ST)..... 318  
 SUPERIJBRE (SU)..... 322  
 TRI-FLOW LUBRICANT (TF) ..... 323  
 USCAN (UC)..... 324  
 VON DUPRIN (VD)..... 333  
 WEISER (WE) ..... 339  
 YALE (YA) ..... 340  
 YOUNG BROTHERS (YB) ..... 343



## INDEX

**Access Control / Keyless Entry**

Alarms / Alarmed Locks / Sirens.....	25, 77-82, 333
Batteries - Back Up .....	315
Card Readers.....	46, 159-162
Controllers.....	46-47, 159-162
Credentials / Prox Cards, Tags, Fobs.....	48, 59, 160, 163
Digital Keypad Locks - Stand Alone .....	23, 58, 305
Door Loops.....	20, 53, 157, 188, 274
Door Position Switch (Monitor).....	307
Mechanical Push Button Locks.....	147-152

**Electrified**

Cylindrical Locks.....	52
Exit Devices.....	53, 83
Gate Lock.....	312
Hinges.....	52
Latch Retraction Kits.....	53, 140, 284-285, 331
Mortise Locks.....	52
Storefront Dead Latches.....	14
Strikes.....	13, 14, 22, 106, 116-121, 188-189, 272-273, 311, 331, 333-335
Keypads.....	14, 22, 131, 188, 312-313
Magnetic Locks.....	18, 21, 188, 275, 306, 308- 310, 330
Mechanical Pushbutton Locks.....	147-152, 304
Monitor Switch - for A/R Exit Devices.....	15
Power Supplies / Transformers.....	13, 15, 53, 80, 273, 306, 314, 336
Rectifiers.....	15, 121, 336
Refrigerator Lock - Electronic .....	59
REX (Request to Exit Devices)	
Touch Sense / Push Devices.....	21, 189, 307, 311
Motion Sense Devices.....	20, 189, 311, 315
Push Buttons.....	20, 21, 313
Software.....	25, 59, 115, 307
Switches - Keyed.....	56, 63, 274, 307
Timers.....	315
Wire Transfer / Power Transfer .....	315, 336
Wireless Control.....	19, 25

**Automotive**

Cylinders / Parts / Face Caps .....	1, 39, 318-321
Keys / Shells .....	321
Programming / Cloning Equipment .....	17, 143, 146
Remotes / Shells.....	146

**Cabinet / Cam Locks**

Cam Locks - Single Bitted.....	49, 54, 60, 64-65, 248
Cam Lock Cover .....	57
Combination Cam Locks .....	51
Door / Drawer Locks .....	49-50, 61, 65, 68, 73, 99, 247-250
Dust Shutter Cam Locks .....	66
Electronic.....	58, 63, 121, 273
Enclosure Locks (panelboard).....	51

File Cabinet Locks .....	54, 69, 70, 99, 317
Mailbox Locks.....	44, 49, 66, 99, 134

**Cabinet / Cam Locks — continued**

Multi-Cam Locks.....	60-64
Replacement Cams .....	61, 72
Sliding Door Locks - Push / Plunger.....	56, 62, 67
Tubular Cam Locks .....	55, 60

**Commercial Hardware****Aluminum Storefront Hardware**

... Cam Disc.....	10, 16, 330
... Cyl. Escutcheon .....	16
... Dead Latches.....	7, 8, 330
... Exit Device - Narrow Stile.....	12
... Exit Indicator - for MS Bolt.....	10
... Faceplates.....	9, 330
... Hook Bolt .....	7
... Interconnected Latch/Bolt/Lever (Dual Force) 14	
... MS Dead Bolt (Flip-Bolt) .....	7
... Paddles .....	10, 330
... Strikes (Mechanical).....	8
... Lever for Dead Latch .....	10, 330
... Lever for Dead Latch (Eurostyle).....	10
... Lever for MS Dead Bolt (W/Indicator).....	10
... Vert. Bolts for MS Lock .....	9
Actuator / Kits - for Opener .....	187, 189, 240
Astragals.....	254
Automatic Openers.....	186-187, 241
Continuous Hinges.....	207, 255, 316
Cylinder Guards / Collars.....	157, 199
Dead Bolts - Grade 1 .....	224, 291
Dead Bolts - Grade 2 .....	32, 104, 284, 291
Dead Bolt - Mortise (Lori Style Bolt) .....	138
Door Bottom Seals .....	255
Door Closers .....	31, 32, 77, 98, 100, 104, 180-187, 241-246, 283, 329
Door Coordinator.....	141-142
Door Silencer.....	142
Drop Plates - for Closers .....	140, 245-246
Exit Devices.....	34, 76, 100-101-102, 256, 274, 282-283, 331, 333, 340
Exit Trim.....	24, 34, 76, 101, 256, 283, 331, 333
Filler Plates .....	91-92, 264
Flush Bolt .....	95, 141
Hinges.....	95, 207, 228, 255, 316
Indicator Dead Bolt .....	291
Knobs - Grade 1 & 2.....	281, 324-326
Latch Protectors .....	88-90, 107, 121, 124, 179, 199, 265-266
Levers - Grade 1 & 2.....	33, 43, 75, 105, 281-282, 287-290, 324-325, 341

INDEX

Mortise Locks .....43, 75-76, 105, 282, 290,  
 .....296, 337  
 Mounting Brackets .....199-200  
 Mullion – Removable .....82  
 Pivot Hinge – Reinforcing .....15  
 Rain Drip .....254  
 Sliding Door Locks .....11  
 Smoke Seals .....255  
 Software - Masterkeying .....137  
 Stops .....96, 142  
 Strikes .....87-88, 267-269  
 Surface Bolts .....141  
 Sweeps .....252-255  
 Thresholds .....252-255  
 Weatherstripping .....252-255

**Cylinders**

Key In Knob/Lever / Universal .....75, 113, 132-133, 299, 328  
 Modular .....112, 301  
 Mortise .....75, 110-112, 132-133, 298,  
 .....328  
 Rim .....75, 110, 113, 133, 135,  
 .....298, 328

**Interchangeable Core**

FSIC – Full Size Cores .....108, 300  
 FSIC – Housings .....108, 300  
  
 SFIC – Small Format Cores .....41, 109, 167  
 SFIC – Housings .....43, 109, 167-168  
 SFIC – Pins / Kits .....42

**High Security/Key Control**

•..American Lock .....28  
 •..Assa Abloy .....35-37  
 •..Kaba .....151  
 •..Medeco .....229-238  
 •..Schlage .....298-302  
 •..Uscan .....328

**Misc. Locks/Hardware**

Annunciator System .....251  
 Blockade Bar .....201  
 Cuff Lock (for bikes) .....221  
 Dogging Key .....15, 103, 256, 331, 337  
 Door Scope / Viewers .....94, 97, 263, 341  
 Gate Lock - Secret .....198  
 Gun Lock .....217  
 Header Signs – “...must remain locked...”16  
 Hide-A-Key .....99  
 Hitch Locks .....222-223  
 Hole Cover .....92, 264  
 Jamb Reinforcer .....198  
 Key Cabinets .....125, 166  
 Key Chains, Rings, Tags, Etc. ....126, 164, 191-197  
 Key Safes – Lock Boxes .....6, 44, 126, 165, 221  
 Kick Down Holders .....96, 141

Kick Plates .....93  
 Knob Cover – “Kee-Blok” .....198  
 Knob Saver .....45, 96  
 Patio Door Lock .....267  
 Profile Cylinders .....113  
 Pull Handles .....93  
 Pull / Push Plates .....93  
 Remodeler Plates / Kits .....94, 171  
 Showcase Locks – for Sliding Glass .....264  
 Slide Lock Bolt .....95  
 Spindles .....135  
 Vending Machine Lock .....55, 57, 62  
 Weldable Gate Box .....157  
 Window Locks .....269  
 Wrap-Arounds , Scar Plates, Hole Fillers .....84-86, 91-92, 269-271

**Padlocks**

Padlocks .....5, 26-27, 37, 43, 51,  
 .....208-218, 297, 331  
 Chains / Collars .....221  
 File Cabinet Bars .....5  
 Heavy Duty Hasps .....28, 222

**Residential Hardware**

Bit Key Mortise Lockset .....134  
 Dead Bolts, Knobs, Lever Locks – Grade 2 & 3 169-170, 223-227,  
 .....286-288, 292, 327, 339  
 Dead Lock / Jimmy Proof / Night Latch (Rim Locks) 97, 134-  
 .....135, 340  
 Door Hardware .....95, 263-264  
 Electronic Locks .....273, 293, 304, 340  
 Garage Door Locks / Handles .....40, 71  
 Sliding Door Locks – Hookbolt / Deadlocks 7, 11  
 Strikes .....87, 297

**Safe Hardware**

Hinge Shim Kit .....198  
 Safe Locks / Dials / Parts .....30, 155-156, 277-280  
 Safe Deposit Locks .....279

**Tools and Equipment**

**Automotive**

...Auto Pick Sets .....1  
 ...Auto Pinning Kits .....320  
 ...Car Opening Tools .....1, 258-259-260  
 ...Impressioning Tools .....261  
 ...Miscellaneous Tools .....1, 130  
 ...Reference Books / Software .....1, 38

**Door / Lock Installation**

...Door Lifter .....201  
 ... Door Pressure Gauge .....187  
 ... Door Tote (Cart) .....201  
 ... Installation Jigs / Kits .....1, 171, 199, 202-204, 257  
 ...Router Bit .....204  
 ... Screws .....201



INDEX

**General**

Broken Key Extractor .....4, 128  
 Drill Bits..... 158  
 Files .....240  
 Cash Box Nut ..... 134  
 Miscellaneous Hand Tools ..... 129  
 Hinge Doctor ..... 122  
 Lever Opening Tool ..... 158  
 Lubricants .....40, 42, 122, 179, 276,  
 ..... 322-323  
 Mortise Cyl. Removal Tools.....3  
 Mortise Tap & Die ..... 129  
 Paint..... 187  
 Pick Guns.....127,261  
 Pick(s) / Sets .....2, 3, 126, 127-128, 262  
 Plug Followers..... 128, 158  
 Plug Spinner ..... 3  
 Scopes - Oto/Multi.....261  
 Screw Remover.....157  
 Screwdrivers - Mega Pro.....239  
 Shims.....3  
 Snap Ring Pliers.....4  
 Stamps - Alpha / #.....343  
 Tubular Saw .....3, 129  
 Tubular Pick .....3, 127  
 Tweezers.....4, 129, 174  
 Wire Stripper.....4

**Key Machines**

Code Milling Machine..... 136  
 Duplicator - Manual ..... 124, 136, 144  
 Duplicator - Semi/Auto..... 135-136, 276  
 Duplicator - High Security ..... 136  
 Parts / Cutters.....123-124, 137, 144  
 Punch Key Machine.....260

**Pinning Kits**

American Lock Padlock.....29  
 Assa - Twin, V-10, 6000, etc. ....37  
 Chicago - Single Bit Kit.....57  
 Fort.....61  
 Master Lock Padlock .....219  
 Medeco.....237  
 National - Disc .....72  
 SFIC .....172  
 Standard - Schlage, Kwikset, etc. ....172-174, 297

**SFIC**

Capping Block / Punch.....2, 42, 168  
 Decoding Tools .....2,174  
 Ejector Pin.....2, 42, 168  
 Pins.....177  
 Pinning Kit.....42

**Specialty**

Nose / Door Pullers - Safe Deposit.....130, 200  
 Safe Change Keys / Set.....157  
 Dispenser Key Sets.....83  
 Tools and Accesories.....123, 297

**New Products**

Locnox Gate & Fence Locks & Hardware ..... A1  
 Fativan Heavy Duty Door Stopper ..... A2  
 American Permalight Photoluminescent Exit Signs ..... A12  
 Codelocks Electronic Cabinet Locks ..... A13  
 Dakota Alert Wireless Security Equipment ..... A14  
 Gate & Fencing Hardware ..... A15  
 Original Lishi Tools ..... A16  
 Lockdown Hardware For Schools & Offices ..... A17  
 Rockwood Architectural Door Accesories ..... A18  
 Tether Technologies Gravity - Digital Tethering Solution ..... A19  
 Washroom Anti-Ligature Healthcare Accesories ..... A20  
 Master Lock Safety Solution ..... A21  
 DoorJak Door Installation Cart ..... A22

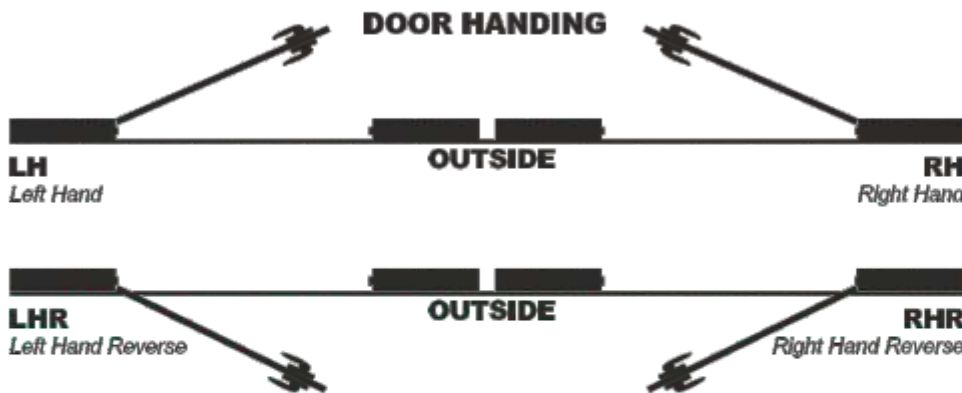

### HOW TO HAND A DOOR

Note: When handing door closers, left hand reverse bevel and right hand are identical. Also right hand reverse bevel and left hand are identical. Corner bracket mounted closers require closer be handed opposite the hand of the door.

### FINISH CHART

ANSI/BHMA Code	Nearest U.S. Standard	Description
602	US2C	Cadmium on Steel
603	US2C	Zinc on Steel
604	US2G	Zinc/Dichromate on Steel
605	US3	Bright Brass
606	US4	Satin Brass
612	US10	Satin Bronze
613	US10B	Oil-Rubbed Bronze
619	US15	Satin Nickel on Brass
625	US26	Bright Chromium on Brass
626	US26D	Satin Chromium on Brass
628	US28	Satin Aluminum, Anodized
630	US32	Satin Stainless Steel
631	US19	Flat Black Coated Steel
632	US3	Bright Brass on Steel
639	US10	Satin Bronze on Steel
640	US10B	Oil-Rubbed Bronze on Steel
651	US26	Bright Chromium on Steel
652	US26D	Satin Chromium on Steel
710	313	Dark "Bronze" Aluminum
—	335	Black Aluminum

\*Fried Brothers, Inc. is not responsible for any incorrect or misrepresented information on this chart.



## GENERAL SALES POLICY

Prices are subject to change without advanced notice.

Payment terms on invoices are Net 30 days.

Freight will be prepaid and added to the invoice. Freight prepaid orders will qualify per your pricing program. Prepaid freight excludes heavy items (such as safes, door closers, key machines, etc.) and shipping charges incurred by special orders and drop shipments. Please read the notice on page xii regarding lost or damaged freight.

Minimum invoice is \$25.00. Orders under \$25.00 will be subject to this minimum.

Special orders for non-stock merchandise must be accompanied by a purchase order. After the order is placed with the factory, it cannot be canceled and is not returnable; except in the case of an error by the factory. Freight will be charged on all special orders.

All returned checks are subject to a \$40.00 handling charge and the account will be reviewed. Repeated problems with bad checks will cause an account to be handled on a cash only basis.

FBI Security Products' handling of defective goods is determined by the original manufacturer's warranty policy. This includes the length of warranty and whether a defective item will be replaced, repaired, or credited.

We accept Visa, MasterCard, Discover, and American Express.

All accounts will be subject to a minimum annual purchase total of \$1,500.00 to remain active. All accounts will be reviewed on a quarterly basis.

**If you do not see what you want in our annual catalog,  
give us a call and we can special order it for you.**



## RETURNED GOODS POLICY

- FBI's handling of defective product is determined by the original manufacturer's policy. This includes the length of warranty and whether a defective item will be replaced, repaired or credited. Any item not purchased from FBI Security Products that is covered under the manufacturer's warranty will be either repaired or replaced, no credit will be issued.
- Customers must call to obtain a Returns Goods Authorization (RGA) number before sending product back or dropping off at our Will Call Desk for return. All returns must be accompanied by an RGA number to avoid delays in processing your return. Items returned without an RGA will incur a \$25.00 service charge. RGA's are valid for THIRTY (30) days from date of issue.
- You may return non-defective product which is current stock, complete, unused, and in saleable condition. Installed electronics, including wires that looked to have been twisted will not be accepted. Products requiring reconditioning (new boxing, packaging, missing screw packs or instructions, etc.) to a saleable condition will not be accepted. Customers are responsible for the cost of return freight of non-defective product sent back to FBI for credit.
- Stock items returned within 10 days will have no restock charge. Items returned 11-60 days from date of purchase will incur a 25% minimum restock charge. Items over 60 days from date of purchase are not returnable for credit.
- Special ordered non-stock merchandise is NOT RETURNABLE, except in the case of an error by the factory or product failure. Clearance, discontinued and obsolete products are also NOT RETURNABLE. No exceptions.
- Products found defective within 30 days can be returned at FBI's expense when requested. After 30 days, return shipping charges on defective items is the responsibility of the customer. Warranty, repaired or replaced items will be returned freight prepaid.
- All ELECTRONIC products will be subject to the manufacturer's warranty. You will be required to call the manufacturer's tech support before obtaining an RGA from FBI. Terms and conditions vary by manufacture. Some items may be returned for repair only.
- Advance Replacement for defective product will be billed to customer until potential defective item is returned. Credit will only be issued when the manufacture issues credit. It's the manufacture's option to repair, replace or credit. Repaired, refurbished or ETN (equal to new) product will be returned to the customer and they will be billed for the advanced replacement. Defective product must be received within 15 days of RGA issue.

Rev: 08/26/2019



**RETURNED GOODS AUTHORIZATION REQUEST FORM**



To submit a request for a RGA#  
Please provide the following:

Order#
Ship Date:
Customer PO#

Customer# \_\_\_\_\_

Fax: \_\_\_\_\_

Company Name: \_\_\_\_\_

E-mail: \_\_\_\_\_

Contact Name: \_\_\_\_\_

Contact Phone: \_\_\_\_\_

Vendor Return Ticket# <small>(When Applicable)</small>
---

Qty	Date Code	Vendor Code & Part Number	Reason for Return

**Procedure** Complete this form.  
E-mail or Fax to our returns department [dawn@FBIsecurity.com](mailto:dawn@FBIsecurity.com)  
Our returns department will fax or e-mail you your RGA number within 24 hours.  
Print return RGA form and include with return package.  
Please return product in original packaging along with this form.  
**DO NOT WRITE ON ORIGINAL RETAIL BOX.**

**Notes**

**Ship To** Fried Brothers, Inc. 467 North 7th Street, Philadelphia, Pennsylvania 19123, USA

## DAMAGED OR LOST MERCHANDISE

Extreme care should be exercised by anyone receiving merchandise from a common carrier. The transportation industry is in the process of deregulation and is taking a very firm stand on freight claims.

We have listed several items which you should be aware of concerning the transfer goods.

1. When we ship the goods, we receive a signed bill of lading acknowledging that the transportation company received the shipment in good condition.

OUR RESPONSIBILITY FOR THIS SHIPMENT HAS NOW CEASED.

2. You should thoroughly inspect the shipment as soon as it is received for visible damage to the shipping container.

3. If any of the goods on the freight bill are short or damaged - DO NOT SIGN THE FREIGHT BILL UNTIL THE FREIGHT AGENT (DRIVER) MAKES A NOTATION ON YOUR COPY OF THE FREIGHT BILL.

4. If any concealed damage is discovered, notify your freight agent at once and request them to make an inspection. YOU MAY DO THIS BY PHONE, BUT IT MUST BE CONFIRMED IN WRITING AND IT MUST BE DONE WITHIN 15 DAYS OF DELIVERY. You must also retain the damaged shipping container for the inspector.

5. We are willing to assist you in collecting claims for loss or damage, but this willingness on our part does not make us responsible for the collection of claims or replacement of this material.

**WE WILL NOT BE ABLE TO HELP YOU WHEN YOU GIVE ANY CARRIER OR TRANSFER AGENT A CLEAR RECEIPT.**





## Photoluminescent Safety & Exit Signs



**Photoluminescent  
NO EXIT Sign**



**Photoluminescent  
Emergency & Fire Safety Sign**



**Photoluminescent Emergency  
Exit Sign Self Adhesive**

## Egress Path Markings



**Safety Walk Anti-skid  
Strip Self-adhesive**



**Man/Arrow Aluminum  
Directional Signage**



**Safety Marker Anti-Skid +  
Arrow Self-adhesive Power**

## Safety Bumper Guards



**H+ Corner Bumper Guard with  
Stainless Steel mounting support**



**E Type Corner Bumper Guard,  
NON-Glow - Self-adhesive**



**A Type Corner Bumper Guard,  
NON-Glow - Self-adhesive**

- Energy efficient photoluminescent exit signs in compliance with UL924.
- Non-electrical: Easy do-it-yourself installation using a screw driver. No electrician needed.
- No light bulbs to change: Maintenance free for 25+ years. No expiration date.
- No energy consumption: Savings on your electricity bill. 3 different materials available: Plastic, aluminum and acrylic.



# CODELOCKS

control + convenience

ELECTRONIC CABINET LOCKS



## **Codelocks CL1007 LH Push Button Digital Electronic Locker and Cabinet Lock, Horizontal 1" Thick Door, Left Handed**

This CL1007 Push Button Electronic Cabinet Lock, by Codelocks, is for your little space within a larger semi-private domain. Keep your diary, money, or heirlooms safe in your drawers, cabinets or lockers with this electronic lock.



## **Codelocks CL1005 LH Push Button Digital Electronic Locker and Cabinet Lock 1/2" Thick Door, Left Handed**

CL1005 Push Button Electronic Cabinet Lock by Codelocks to look with its ability to go in either vertical or horizontal fashion on doors up to 1/2" thick. Keep your things safe from co-workers, or prying family by using the ten digit keypad to create your personalized number.



## **Codelocks CL1006 LH Push Button Digital Electronic Locker and Cabinet Lock 3/4" Thick Door, Left Handed**

Suitable for any of your drawers, cabinets, or lockers where you store your secret stash-honestly whatever it is it's your business, we won't ask! With this electronic lock you can enjoy the much deserved privacy you crave in some not-so-private spaces.



## **Codelocks KL1200 Heavy Duty Push Button Digital Electronic Locker and Cabinet Lock**

The CL1200 Cabinet Lock new Cabinet Lock from Codelocks. A quick retrofit for keyed cam locks supplied as standard on a wide range of lockers, cabinets and cupboards.





## Dakota Alert Driveway Alarm and Floodlight

### Dakota Alert Driveway Alarm and Floodlight

The DCPA-2500 is a driveway alarm kit that is used to detect vehicles only. The DCR-2500 receiver has four form "C" relay outputs and one 12VDC output. The output durations are adjustable up to 10 minutes. The receiver will play one of four different tunes that are selected at the transmitter so that different zones can be distinguished.



### DCRH-2500 Driveway Alarm

The DCRH-2500 is a very reliable and easy to install driveway alarm. The transmitter operates on one 9-volt battery and has 25' of 3/8" diameter exterior hose that will lie across the drive. When a vehicle drives over the hose, a signal will be sent to the DCR-2500 receiver up to 1/2 miles away\*.



### DCMA-2500 Wireless Motion Detector/Receiver Kit

The DCMA-2500 is a feature filled wireless motion detector/receiver kit with a 1/2 mile\* radio range. The passive infrared sensor operates on one 9-volt battery (not included). It will detect a person or vehicle from over 50 feet away and send a signal back to the receiver within a 1/2 mile.



### HM LED Floodlight with PIR (Passive Infrared) Motion Detector

- Low energy/exceptional illumination. Generates around 100 lumens per watt.
- Utilizes the latest Samsung™ LEDs with a lifespan of up to -50,000 hours
- Includes a large junction box with 5 access points. Built in photocell for night operation.
- Easy installation with 3 simple adjustments: Time, light level -and motion detection.
- Walk test facility for daytime testing. Manual override for use on switched circuit.



# GATE & FENCING HARDWARE

**HYDROLIC GATE  
CLOSER & HINGE**

**GATE PANIC  
EXIT PUSH BAR**

**GATELOCK**

## Locks



**Locinox LMKQ  
V2 VINCI Mechanical  
Code Lock 2 Sided  
for Swing Gates**



**Securitron GL1  
2000lbs Holding  
Force Gate Lock**



**Locinox LEKQ U4  
Electric Lock - Fail  
Open for Swing  
Gates**



**Keeps**  
This unique keeper  
combined with the  
Hybrid lock ensures  
a strong anchoring.



**Hinges**  
The hinge is adjustable  
in three dimensions; height,  
left/right alignment and  
swing direction.



**Gate Closers**  
Complete Range Of High  
Quality Gate Closers



**Dropbolts &  
Ground Catchers**  
It is surface mounted  
for easy access and  
installation.



**Gate Catchers**  
The adjustable catch reaches  
under the gate catching the  
bottom rail and the hook  
can easily be reversed.



**Accessories**  
accessories includes :  
- Locks And Keeps  
- Security Strips  
- Miscellaneous

## Water Resistant Keypad & Accessories



The SlimStone keypad with integrated LED lighting, is unique in its kind. The keypad is developed and tested to guarantee uninterrupted use in the most extreme weather conditions and all circumstance.





Improve your Lishi picking skills with this handy training vise!

COMP#	Mfg No	Description
710262	LISHI VICE	Lishi Training Vise
710266	PFTPD (FORD TIBBE)	Lishi Premium Tibbe Pick Set
710004	F038+AG	Lishi Ford 8-Cut With Ign/Dr/Bt. Anti Glare
710078	B111-AG	Lishi Gm Z-Keyway (Warded) Anti Glare
710024	CY24-CV-AG	Lishi Chrysler 8 Cut,5 Depth F/Commercial Vehicle Antiglare
710067	GM37-AG	Lishi Gm B106/107 Non-Warded 10 Cuts- Anti Glare
710069	GM39-AG	Lishi Flat 10-Cut For Gm And Chevrolet- Anti Glare
710128	HON58R	Lishi Flat 8-Cut, For Honda And Isuzu
710050	HYN15(HY17)-AG	Lishi Hyundai Ilco X269 Anti Glare
710147	ISU5/B113(ILCO)	Lishi Flat 10-Cut For Isuzu
710154	MAZ24R+	Lishi For Mazda And Ford. Ign/Dr/Bt.
710163	MAZDA2014	Lishi For Mazda 2014 Onwards (New Mazda Smart Keyway)Dr/Bt.
710140	MIT8	Lishi 2In1 Pick & Decoder For Mitsubishi.Dr/Bt.
710142	MIT8+	Lishi For Mitsubishi Ignition
710071	NSN14+AG	Lishi 10-Cut For Nissan, Ford And Subaru- <b>Ignition</b> Anti Glare
710017	NSN14-AG	Lishi (10-Cut) For Nissan,Ford & Subaru. <b>Door &amp; Trunk</b> Anti Glare
710096	TOY43+AG	Lishi 8-Cut For Toyota Ignition Locks Anti Glare
710088	TOY43-8-AG	Lishi Old Toyota 8-Cut Split Wafer,Toyota Camry Door Only
710106	TOY43AT+IGN-AG	Lishi Flat 10-Cut For Toyota Ignition Only. Anti Glare
710118	TOY43AT-AG	Lishi Same As Ilco Tr47 3-10 Cut,Door Only, Anti Glare
710119	TOY43R-AG	Lishi (B108/B110) For Isuzu, Gmc, Chevrolet, Anti Glare
710008	HON86+AG	Lishi 4 Track External Twin Lifter For Honda Ign/Dr/Bt
710034	HU100+(10)-AG	Lishi (10Cut),For Gm,Cadillac, Chevrolet.Ign/Dr/Bt. Antiglare
710072	HU100+(8-CUT)	Lishi 8-Cut For Buick,Cadillac Chevrolet,Opel,Vauxhall,Ign/Dr
710044	HU100R/HU127-V3-AG	Lishi 2 Track Internal For Bmw F-Series. Anti Glare
710066	HU101+V3-AG	Lishi 2 Track External F/Ford, Volvo& Range Rover Ign/Dr/Bt.
710134	HU39+QL	Lishi 4-Track External, Quad Lifter For Mercedes Ign/Dr/Bt
710166	DAT17	Lishi For Nissan,Subaru 10Cuts 4 Track External High Security
710039	HU66+SL-AG	Lishi Single Lifter F/Vw,Audi, Ford,Seat,Porsche. Ign/Dr/Bt.
710138	HU92+SL	Lishi Bmw Single Lifter
710208	HY20	Lishi Single Lifter For Hyundai And Kia.Dr/Bt.
710250	HY20R	Lishi Single Lifter For Hyundai Dr/Bt.
710253	HY22+AG	Lishi 4 Track Internal Quad Lifter For Hyundai And Kia
710259	K9	Lishi 2In1 Pick And Decoder For Kia.
710070	NE66+AG	Lishi 4 Track For Volvo. Ign/Dr/Bt. Anti Glare
710065	SIP22-TL-AG	Lishi Twin Lifter For Fiat, Lancia,Alfa Romeo And Iveco.
710077	TOY2T-AG	Lishi 2 Track Ic:1342.1510 For Toyota- Anti Glare
710127	TOY48+AG	Lishi Quad Lifter For Toyota And Lexus.Ign/Dr/Bt.Anti Glare
710254	VA6-QL-AG	Lishi Lifter F/Renault,Citroen Peugeot, Samrt 2015 Onwards

### Residential Tools

710267	AM5	Lishi 2In1 Tool For American Lock Padlock Keyway Am5,6 Pins
710174	KW1-AG-5 PINS	Lishi Kwikset 2In1 Tools Non-Sidebar, Usa Dealers Only
710234	KW5-AG-6 PINS	Lishi Kwikset 2In1 Tools Usa Dealer Only
710167	SC1-AG-5 PINS	Lishi Schlage-Usa Dealers Only
710222	SC4-AG-6 PINS	Lishi Schlage-Usa Dealers Only

SC1-AG



# Lock Down Your School Security & Your Budget



## Lockdown Hardware For Schools & Offices



**Alarm Lock DL2700LD  
Lockdown Trilogy T2  
Cylindrical Keyless**



**Marks USA LocDown™  
Series Cylindrical  
Lockset w/ F110**



**Marks USA LA318GJ  
LocDown™ Mortise Lockset  
with Classroom Security**



**Trimco LDH100 Panic  
Button Lock Down  
Hardware for Exit Devices**



**Alarm Lock ArchiTech N90L  
Access Control Networked  
Lock with F110**



**Marks USA LA318  
LocDown™ Mortise Lockset  
with Classroom Functions**



**Securitech SB175 SAFEBOLT™  
Instant Keyless  
Lockdown Lock**



**Securitech QID Quick  
Intruder Deadbolt Lockdown  
Lock - Cylindrical**

## Metal Detectors



**ZKAccess HMD100  
Hand-held  
Metal Detector**



**ZKAccess WMD118  
Walk-through Metal  
Detector**



**ZKAccess WMD318  
Walk-through  
Metal Detector**



**ZKAccess WMD433  
Walk-through  
Metal Detector**



# ARCHITECTURAL Door Accessories

## ROCKWOOD

The global leader in  
door opening solutions

ASSA ABLOY



**Push And Pull Plates**



**Coordinators**



**Protectors**



**Door Stops, Holders & Bumpers**



**Door Knockers & Viewers**



**Offset Pull Bars**



**Door Pulls**



**Door Guards**



**Flush Pulls**



**Edge Pulls**



**Pocket Door Hardware**



**Ball Catches & Roller Catches**



**Signs**



**Filler Plates**



**Vandal Resistant Trims**



**Miscellaneous**



**Never Risk Losing Your Master Keys or Access Cards Again**



## Digital Tethering Solution & Accessories



In the U.S. today, nearly 15 million master key sets are in use with millions spent annually on key rings and cabinet systems to account for keys before and after a shift.



### Tether Technologies Gravity Digital Tethering Solution

Gravity closes the risk gap in current access control solutions utilized by security, janitorial and engineering employees.

Gravity is the only industrial-grade, digital tethering device that eliminates human error from master key loss.



### Tether Technologies Gravity Un-Pairing Station

The un-pairing station allows you to store the key unit only while the belt unit powers off, so as not to take up space in the cabinet.



### Tether Technologies Gravity Belt Clip

Replacement clips are not needed for Gravity purchases, as each Gravity unit comes with our three Standard Clip options.

# Washroom Anti-Ligature Healthcare Accessories



**Grab Bars**

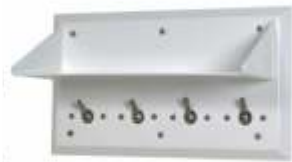

**Anti Ligature Shelf**



**Anti Ligature Mirrors**



**Anti Ligature Toilet  
Paper Holder**



**Anti Ligature Toilet  
Seat Cover**



**Folding Shower/  
Dressing Seat**



**Recessed Specimen  
Pass-Thru Cabinet**



**Anti-Ligature  
Access Panel**



**Anti-Ligature  
Hook panel**









**AUTOMOTIVE**

	<p><b>AFPS2</b> <i>Complete Service Kit for GM</i></p> <p>For picking &amp; decoding 10-cut in-column ignitions. Includes tension tools &amp; rocker picks, release tool and decoder.</p>		<p><b>AFRPS06t</b> <i>Style A Tension Tool</i></p>
	<p><b>AFPS10</b> <i>GM 10-Cut In-Dash/Column Complete IGN Service Kit</i></p>		<p><b>AF6</b> <i>GM Decoder (for GM 6-cut)</i></p> <p>Decode GM 6-cut sidebar without complete disassembly.</p>
	<p><b>AF47</b> <i>Set Of Rocker Picks</i></p> <p>4 double sided and 4 single sided rocker picks. For foreign &amp; Domestic auto.</p>		<p><b>AFCO2</b> <i>Vulcan Button Grabber</i></p> <p>Rubber loop grabs &amp; pulls door lock posts on many cars.</p>
	<p><b>AFPS3-025</b> <i>Release Tool</i></p>		<p><b>AF43</b> <i>A-1 Fighting Wedge</i></p> <p>Inlatable wedge can exert extreme pressure to widen the gap. Push-button release valve.</p>
	<p><b>AFPS3-026</b> <i>Tension Tool</i></p>		<p><b>AF17328</b> <i>RV Code Book</i></p>









**INSTALLATION JIGS**

	<p><b>AFBUL-1</b> <i>Cabinet Lock Installation Jig</i></p> <ul style="list-style-type: none"> <li>• Aluminum alloy</li> <li>• Built-in level</li> <li>• 2 Steel bushings for 3/4" and 1 1/8" - 1 1/4" cam locks</li> </ul>		<p><b>AFBUL-2</b> <i>Cylindrical Lock Installation Jig</i></p> <ul style="list-style-type: none"> <li>• Facilitates 1 1/2" &amp; 2 1/8" cross bores</li> <li>• Backset adjustment toggle</li> <li>• Neoprene door grip pads</li> </ul>
			<p><b>AFBUL-3</b> <i>Bull's Eye Retrofit Jig for Lever Locks</i></p> <ul style="list-style-type: none"> <li>• Backset adjustable from 2 3/4" - 5"</li> <li>• Door width adjustable from 1 1/8" - 2"</li> <li>• Drill from both sides of the door</li> </ul>

**I/CORE TOOLS**



 <p><b>AFICKT Interchangeable Core Tool Kit</b></p> <ul style="list-style-type: none"> <li>• TB1 Decoding Block</li> <li>• TB2 Multi Use Capping Block</li> <li>• TB3 Dumping Block</li> </ul>	 <p><b>AF4 Key Decoder for I/Core</b></p> <p>Now decode keys for 3 systems: A2, A3, and A4.</p>
 <p><b>AFTB2 Multi-Use Capping Block</b></p> <p>Cap standard "Best" style cores plus "Falcon" style with spring covers. Includes capping tool.</p>	 <p><b>AFGP201-A2 Mean Green Machine for Flexcore</b></p> <ul style="list-style-type: none"> <li>• A2 System and Arrow Flexcore vise installed. (standard SFIC vise purchased separately)</li> <li>• Side mounted depth knob and automatic key advance</li> </ul>
 <p><b>AFTBIP Ejector Pin for I/Core</b></p>	 <p><b>AFCS-50 CapSaver Strips (box of 50)</b></p> <ul style="list-style-type: none"> <li>• Enough strips for 200 cores</li> <li>• For use in CapSaver Press</li> </ul> <p><b>AFCS-250 CapSaver Strips (box of 250)</b></p>

**LOCKSMITH TOOLS**

<p><b>AFPCH-01 Double Ball</b></p> 	<p><b>AFPCH-13 Long Comb</b></p> 
<p><b>AFPCH-05 Rake</b></p> 	<p><b>AFPCH-14 Long Rake</b></p> 
<p><b>AFPCH-07 Hook</b></p> 	<p><b>AFPCH-23 Comb</b></p> 
<p><b>AFPCH-08 Deep Hook</b></p> 	<p><b>AFTEN-03</b></p> 

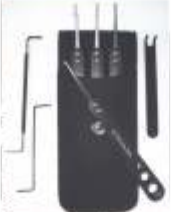

**LOCKSMITH TOOLS**

 <p><b>AF48</b>  <i>Premiere Edition 8-Piece Pick Set</i>  <i>8 picks stainless steel handles a unique chrome plating process that makes the pick ends more rigid. Case included.</i></p>	 <p><b>AF19</b>  <i>Curved Shims</i>  <i>(Package of 25)</i></p>
 <p><b>AF17277</b>  <i>RV Key Blank Kit</i></p>	 <p><b>AF20</b>  <i>A-Pick</i>  <i>Includes decoder &amp; Ace/Tubular pick.</i></p>
 <p><b>AFVPR-S</b>  <i>Viper Pick Set 7 Pieces</i>  <i>Ergonomic red anodized aluminum handles. Highly flexible .0196 thick SS blades. Includes case.</i></p>	 <p><b>AF52</b>  <i>Ace Key Decoder</i>  <i>Quickly decodes Tubular keys.</i></p>
 <p><b>AF44</b>  <i>A-1 Magnum Pick Gun</i>  <i>For internal or external rings.</i>  <b>AF44-REPL</b>  <i>Replacement Picks (4) for Magnum.</i></p>	 <p><b>AF14</b>  <i>Tubular Lock Saw</i>  <i>Pins can remain intact for decoding. Not for use on hardened locks or locks with deadpins.</i></p>
 <p><b>AF26</b>  <i>Plug Spinner</i></p>	 <p><b>AF16</b>  <i>Mortise Cylinder Removal Tool</i>  <i>Removes even the most stubborn mortise cylinders.</i></p>
 <p><b>AFSP1</b>  <i>Spinner - Plug Spinner</i>  <i>Space age plug spinner fits in your shirt pocket or most pick kits. Weighs only 2-1/4 ounces.</i></p>	 <p><b>AF61</b>  <i>Mortise Cylinder Force Tool</i>  <i>Apply over 150 foot lbs. of torque to overcome set screws on most mortise cylinders.</i></p>
 <p><b>AF18</b>  <i>Shim Holder with Shims</i>  <i>Hold curved shims firmly without cutting your fingers. Includes 25 A-1 quality shims.</i></p>	 <p><b>AF50</b>  <i>A1 Multi-Scope</i>  <i>Super intensity LED light with a powerful magnification. Comes with carrying case.</i></p>

**LOCKSMITH TOOLS**

	<p><b>AF KP1 Broken Key Extractor Kit</b> Includes a hook, saw tooth, large spiral (.050) &amp; small spiral (.040).</p>		<p><b>AF 42 Retaining Ring Plier</b> For internal or external rings.</p>
	<p><b>AF 27 Broken Key Pullers</b> Includes .040 spiral, saw tooth, &amp; hook.</p>		<p><b>AF QP A-1's QuickPull</b> Snap out cylinders from Kwikset style knobs in seconds without disassembly. <b>AF QPBL Replacement Blade</b></p>
	<p><b>AF 30 Get-A-Grip Key Puller</b> .040 spiral</p>		<p><b>AF QP-2 A-1's QuickPull 2</b> Removes Schlage 'F' series knobs from the exterior in seconds. <b>AF QP2B Replacement Blade</b></p>
	<p><b>AF 30B Mega Grip Key Puller</b> .074 spiral</p>		<p><b>AF 28 Locksmith Hammer</b></p> <ul style="list-style-type: none"> <li>• 2 oz</li> <li>• One end brass &amp; the other a durable, non-marring plastic</li> </ul>
	<p><b>AF 30-SET Get-A-Grip Set</b></p> <ul style="list-style-type: none"> <li>• .040 x 2</li> <li>• .074 x 2</li> </ul>		<p><b>AF 46 2-in-1 Automatic Cutter/ Stripper</b></p> <ul style="list-style-type: none"> <li>• Cut wire with one end &amp; automatically strip with the other</li> <li>• Self adjusts to wire size. 26 AWG to 14 AWG</li> </ul>
	<p><b>AF 29 Grooved Tweezers</b> Specially grooved for pinning.</p>		<p><b>AF WT1 Wale Tray</b> Keep pins, springs and plugs neatly separated.</p>



**PADLOCKS**

**83/45 REKEYABLE — 1 3/4" Width**

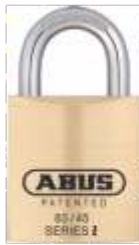

AU83/45-S2 WOC WOS	Series 2 W/O Cyl W/O Shkd	AU83/45-S2-1000	Corbin-Russ. D1-D4
AU83/45-S2 WOC WS	Series 2 W/O Cyl W/Shkl	AU83/45-S2-3000	Schlage C Thru L
AU83/45-S2-100	Yale-8 KR	AU83/45-S2-3000-8004	Sch C Thru L
AU83/45-S2-200	Kwikset	AU83209E	KNK Bible Cover
AU83/45-S2-300	Schlage-C	AU83209H	83KNK Adapter Pk
AU83/45-S2-400	Corbin 59 & 60	AU83209J	KNK Schlage Driver
AU83/45-S2-700	Sargent LA-LC	AU83209K	KNK Medeco Driver
AU83/45-S2-800	Weiser	AU83414A	Shackle Tool

**83IC/45 I/CORE — 1 3/4" Width (Less Cylinder)**



AU83IC/45-1	1" Shackle
AU83IC/45-2	2" Shackle
AU83IC/45-4	4" Shackle

**83WP Series**



AU83916	2 1/2" Shackle for 83WP/53
AU83917	3" Shackle
AU83918	4" Shackle
AU83WP-IC/53 LF-SCHLG	Sch LFIC
AU83WP/53-S2-100	Padlock Extreme
AU83WP/53-S2-300	Yale 0B Rekeyable
AU83WP/53-S2-3000	Padlock Extreme
AU83WP/53-S2-3000	Sch C 0B Rekeyable
AU83WP/53-S2-WOC-WS	Padlock Extreme
	Sch C-L 0-Bitted Rekeyable
	Padlock Extreme w/o Cyl w/Shackle

**83 Series Steel Shackles — For 83/45 83IC/45**



AU8001	1"
AU8002	2"
AU8003	3"
AU8004	4"
AU8009	6"

**24/70 DISKUS — 2 3/4" Width**



AU24/70B-KA-EE0121
AU24/70B-KA-EE0226
AU24/70C-KD
AU24/70RKOB-5PIN (Rekeyable)

**28/70 BUFFO — 2 3/4" Width**



AU28/70B-KA-0028
AU28/70C-KD

**Key Blanks 50 / Box**

AU24/41-KBL	KEY BLANK 4-PIN
AU24/41-KBR	KEY BLANK 4-PIN
AU24RK/26KBL	KEY BLANK LEFT HAND 5-PIN
AU24RK/26KBR	KEY BLANK 5-PIN
AU55/40-KB	KEY BLANK 4 PIN
AU55/45-KB	KEY BLANK 4 PIN
AU55/50-KB	KEY BLANK 5 PIN
AU84/25-KBL	KEY BLANK 3 PIN
AU84/25-KBR	KEY BLANK 3 PIN
AU84/40-KBR	KEY BLANK 4 PIN
AU84/50-KBL	KEY BLANK 5 PIN
AU84/50-KBR	KEY BLANK 5 PIN
AU85/30-KBL	KEY BLANK 4 PIN
AU85/30-KBR	KEY BLANK 4 PIN
AU85/40-KBR	KEY BLANK 5 PIN
AU85/50-60-KBL	KEY BLANK 5 PIN
AU85/50-60-KBR	KEY BLANK 5 PIN
AU97075	TITANIUM COUNTER DISPLAY

**TOOLS & MISC PARTS**

**Re-Keying Kit**



AU24SK-1 Rekeying Kit

**Chain Parts**



AU83910 12" Chain for 83 Series



AU83912 5/16" Chain Collar

## FILE BARS



Convenient knob for easy and smooth operation



Enclosed end for added security and a modern look

- Available in 1-, 2-, 3-, 4-, and 5-drawer versions
- Powder-coat finish
- Constructed of heavy 16-gauge formed steel
- Built-in spring-loaded hinge
- Mounting screws included

AUMLK-1	1-Drawer 11"
AUMLK-2	2-Drawer 21.5"
AUMLK-3	3-Drawer 33.5"
AUMLK-4	4-Drawer 45"
AUMLK-5	5-Drawer 56"

ABUS File Bars swing clear of the file doors

## LOCK BOXES



Four digit resettable combo

AU787C Wall Mount  
AU797C Shackle Mount







# Upgrade Your Solution Mechanical to Electrical

Upgrading from mechanical to electrified hardware doesn't have to be difficult. Adams Rite makes it easy by offering products for aluminum and glass storefronts that can easily enhance your opening and improve the safety and security of your business.

800.872.3267 | [adamsrite.com](http://adamsrite.com)



ASSA ABLOY, the global leader  
in door opening solutions

**DEADLOCKS, HOOKBOLTS & DEADLATCHES**



MS1850S Series

**MAXIMUM SECURITY DEADLOCKS**

- Features:
- Laminated stainless steel bolt
  - Nearly three inches long

**Bronze**

ARMS1852S-315-313	1 1/8", LH
ARMS1852S-316-313	1 1/8", RH

**Satin Aluminum**

ARMS1850S-110-628	3/8" Flat
ARMS1852S-215-628	3/8", LH
ARMS1852S-216-628	3/8", RH
ARMS1852S-315-628	1 1/8", LH
ARMS1852S-316-628	1 1/8", RH
ARMS1852S-415-628	1 1/2", LH
ARMS1852S-416-628	1 1/2", RH
<i>(with short bolt)</i>	
AR1852S-225-628	3/8"
AR1852S-325-628	1 1/8"

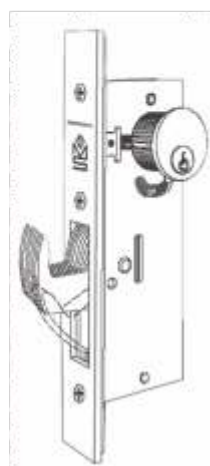

8.0" x 1.25" Face Plate

**HOOKBOLT**  
ANSI Size

- Features:
- For hollow metal or wood sliding doors
  - 1 1/2" backset dimension
  - Provides adequate clearance for the deep jamb "pocket" of many commercial and industrial entrances

**Satin Aluminum**

ARMS1850SN450-628	1 1/2"
-------------------	--------



MS1850S-050 Series

**HOOKBOLT**

- Features:
- Massive laminated hook bolt for sliding glass doors

**Satin Aluminum**

ARMS1850S-250-628	3 1/2"
ARMS1850S-350-628	1 1/8"
ARMS1850S-450-628	1 1/2"



MS+1890 Series

**HOOKBOLT & LATCH**

- Features:
- 360° turn of key or thumbturn throws or retracts the hookshaped deadbolt
  - 120° further turn retracts latch bolt as well
  - Handle or paddle operates latchbolt only

**Satin Aluminum**

ARMS+1891W2015-628	3/8", LH
ARMS+1891W3015-628	1 1/8", LH
ARMS+1891W3016-628	1 1/8", RH
ARMS+1891W4016-628	1 1/2", RH

**4900 HEAVY DUTY DEADLATCH**

For Aluminum Stile Doors

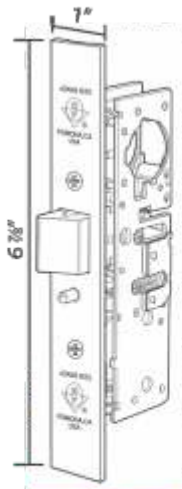

- Features:
- Retrofits to existing 4500/4700 Deadlatch preparations
  - 1 3/4" minimum door thickness required

**Bronze**

AR4900-25-101-313	3/8" LH
AR4900-26-101-313	3/8" RH
AR4900-35-101-313	1 1/8" LH
AR4900-36-101-313	1 1/8" RH
AR4900-45-101-313	1 1/2" LH
AR4900-46-101-313	1 1/2" RH

**Satin Aluminum**

AR4900-25-101-628	3/8" LH
AR4900-26-101-628	3/8" RH
AR4900-35-101-628	1 1/8" LH
AR4900-36-101-628	1 1/8" RH
AR4900-45-101-628	1 1/2" LH
AR4900-46-101-628	1 1/2" RH

**4920 ANSI SIZE DEADLATCH**

For Hollow Metal or Wood Doors

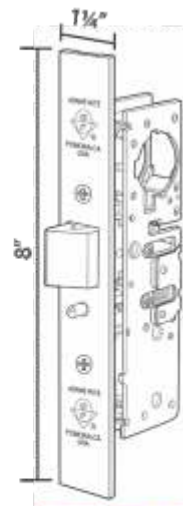

- Features:
- Replaces 4520 and 4720 ANSI Deadlatches
  - 1 3/4" minimum door thickness required

AR4920AN45-602-628	1 1/2" LH
AR4920AN46-602-628	1 1/2" RH

**DEADLATCHES — continued**

**4510 STANDARD DUTY**  
*Deadlatch Series*

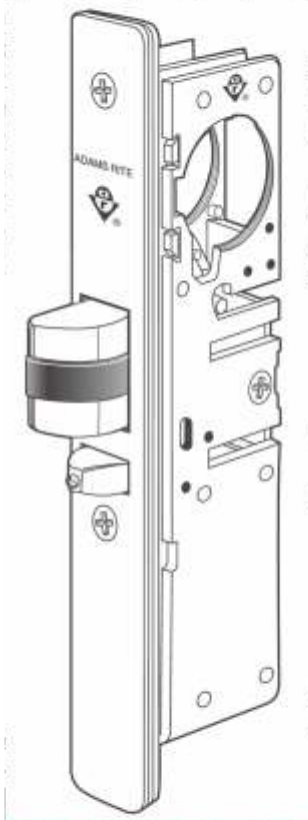



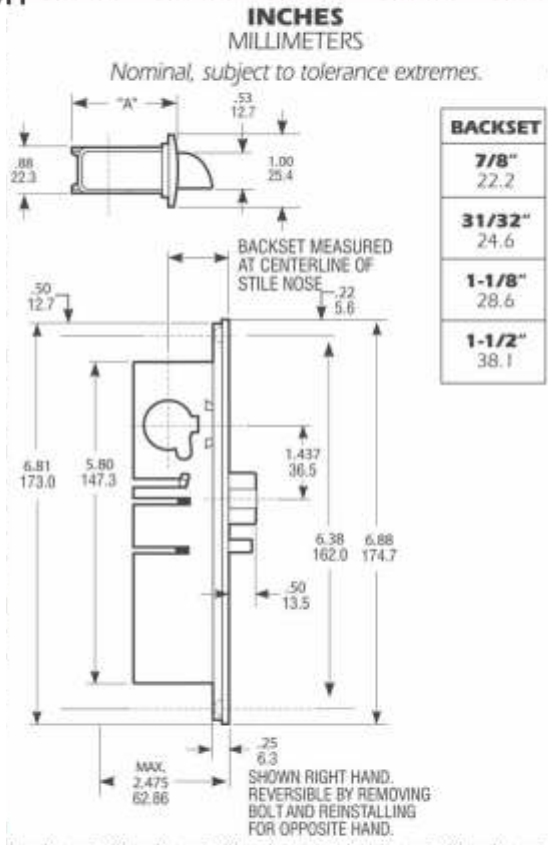

- Bronze**
- AR4512-25-101-313 3/8" LH
  - AR4512-26-101-313 3/8" RH
  - AR4512-35-101-313 1 1/8" LH
  - AR4512-36-101-313 1 1/8" RH
  - AR4512-45-101-313 1 1/2" LH
  - AR4512-46-101-313 1 1/2" RH

- Satin Aluminum**
- AR4512-15-101-628 3/8" LH
  - AR4512-16-101-628 3/8" RH
  - AR4512-25-101-628 3/8" LH
  - AR4512-26-101-628 3/8" RH
  - AR4512-35-101-628 1 1/8" LH
  - AR4512-36-101-628 1 1/8" RH
  - AR4512-45-101-628 1 1/2" LH
  - AR4512-46-101-628 1 1/2" RH

- Less Faceplate & Mounting Tabs**
- AR4513-35-MC 1 1/8" LH □
  - AR4513-36-MC 1 1/8" RH □

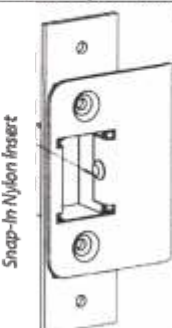

**STRIKES**

 <p><b>4000 TRIM STRIKE</b></p> <p><i>Features:</i></p> <ul style="list-style-type: none"> <li>• Includes machine screws and wood screws</li> </ul> <p>AR4000-011-628 AR4000-031-628 Hook Bolt</p>	 <p><b>4001 BOX STRIKE</b></p> <p><i>Features:</i></p> <ul style="list-style-type: none"> <li>• Steel plated dust box added</li> <li>• For hook bolt</li> </ul> <p>AR4001-031-628</p>	 <p><b>4002 ARMORED STRIKE</b></p> <p><i>Features:</i></p> <ul style="list-style-type: none"> <li>• Backed up by a massive steel doubler</li> <li>• Fits within aluminum or hollow jamb sections with trim face flush, the steel completely hidden</li> </ul> <p>ARMS4002-012-628</p>
 <p><b>4901 DEADLATCH STRIKES</b></p> <p>AR4901-01-121 Large AR4901-01-630 Large AR4901-02-121 Radius AR4901-02-630 Radius</p> <p>Snap-In Nylon Insert</p>	 <p><b>4902 DEADLATCH STRIKES</b></p> <p>AR4902-01-121 Small AR4902-01-630 Small AR4902-02-630 Rad. Short</p> <p>Snap-In Nylon Insert</p>	



FACEPLATES

<p><b>1" x 6 7/8"</b> (FOR MS 1805, MS1805A, MS1950 LONG THROW)</p> <p>AR24-0384-010-313 Flat AR24-0384-010-628 Flat AR24-0384-110-313 Radius AR24-0384-110-628 Radius AR24-0384-210-313 LH AR24-0384-210-628 LH AR24-0384-310-313 RH AR24-0384-310-628 RH AR24-0384-410-313 Radius, W-S AR24-0384-410-628 Radius, W-S</p>	<p><b>1" x 6 7/8"</b> (FOR MS1855, MS1850L, MS1950R/DOORBOLT &amp; SHORTBOLT)</p> <p>AR24-0384-020-313 Flat, Short Hook AR24-0384-120-313 Radius, HB, SB AR24-0384-120-628 Radius, HB, SB AR24-0384-220-313 LH, HB, SB AR24-0384-220-628 LH, HB, SB AR24-0384-320-313 RH, HB, SB AR24-0384-320-628 RH, HB, SB AR24-0384-420-313 Radius, W-S, HB, SB AR24-0384-420-628 Radius, W-S, HB, SB</p>	<p><b>ARMORED FACEPLATE</b> 1" x 6-7/8"</p> <p>FLAT RADIUS LH BEVEL RH BEVEL</p> <p><b>Faceplate Finishes:</b> • 628: Satin Aluminum • 313: Dark Bronze Aluminum</p>
<p><b>1" x 6 7/8"</b> (for MS 1890)</p> <p>AR24-0270-220-313 LH Bevel AR24-0270-220-628 LH Bevel AR24-0270-320-313 RH Bevel AR24-0270-320-628 RH Bevel AR24-0270-420-313 Radius, WS</p>	<p><b>1" x 6 7/8"</b> (for 4900 series locks)</p> <p>AR24-0137-01-313 Flat/Bevel AR24-0137-01-628 Flat/Bevel AR24-0137-02-313 Radius AR24-0137-02-628 Radius AR24-0137-03-313 Radius WS AR24-0137-03-628 Radius WS</p>	<p><b>1 1/8" x 6 7/8"</b> (FOR 4900 SERIES LOCKS)</p> <p>AR24-0140-313 Radius WS AR24-0140-628 Radius WS</p> <p><b>1 1/8" x 7 1/4"</b></p> <p>AR24-0144-01-313 Flat/Bevel AR24-0144-01-628 Flat/Bevel</p>
<p><b>1" x 6 7/8"</b> (FOR 4500 &amp; 4700 SERIES LOCKS)</p> <p>AR24-0017-0220-313 Flat AR24-0017-0220-628 Flat AR24-0017-1220-313 Radius AR24-0017-1220-628 Radius AR24-0017-2220-313 LH Bevel AR24-0017-2220-628 LH Bevel AR24-0017-3220-313 RH Bevel AR24-0017-3220-628 RH Bevel AR24-0017-4220-313 Radius, WS AR24-0017-4220-628 Radius, WS</p>	<p><b>7.41" x 1.25"</b> (for 4530 locks)</p> <p>AR24-0016-120-628 Radius AR24-0016-220-628 LH Bevel AR24-0016-320-628 RH Bevel</p>	<p><b>MS Series Blank Faceplate Kit</b></p> <p><i>Features:</i> • Kit comes with a blank faceplate, mounting tabs and the mounting screws</p> <p>ARBFK-MS1850-10-313 Flat ARBFK-MS1850-10-628 Flat ARBFK-MS1850-11-313 Radius ARBFK-MS1850-11-628 Radius</p>

DEADLOCK — HEADBOLT/THRESHOLD BOLT

**Header Bolt — Three Point Lock (Pairs of Doors only)**  
AR4016-30-01

- Add the 4016 Header Bolt and the 4015 Threshold Bolt to an MS deadbolt
- Three-point lock secures the entire double door entrance

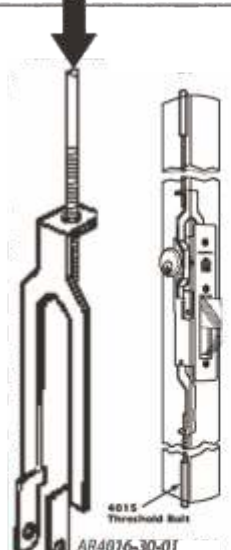

AR4016-30-01

AR4015-18-1B

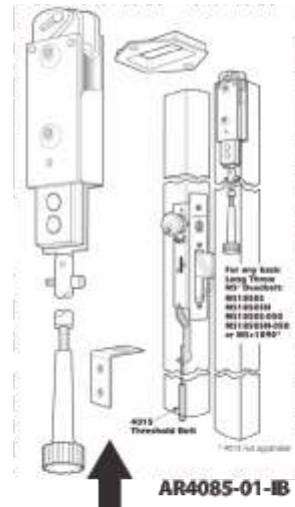

AR4015-18-1B  
Threshold Bolt

AR4016-30-01  
Header Bolt

AR4085-01-1B  
Header Bolt

AR4085-01-1B

**Threshold Bolt - Two Point Lock**  
AR4015-18-1B

- Simultaneously drop a hardened steel hexbolt into the threshold and pivoting the massive MS<sup>®</sup> bolt into the mating door's stile
- Add to MS1850S or MS1850SN deadbolt

**Header Bolt — Three Point Lock (Pairs of Doors only)**  
AR4085-01-1B

- For pairs of doors with an MS<sup>®</sup> pivoted bolt deadbolt and 4015 Threshold bolt in the active leaf
- The 4085 is mounted in the inactive leaf to add a top-of-door third locking point

TRIM



**4550 MS<sup>®</sup> Deadbolt Lever**  
**FEATURES:**

- Unlocking any MS<sup>®</sup> deadbolt by approximately 3 lbs. downward force on a 3" lever
- Indicator signals lock status
- Words "LOCKED" in red letters or "OPEN" in black letters appear on white background

<i>Bronze Aluminum</i>	
AR4550L-01-121	LH/LHR
AR4550R-01-121	RH/RHR
<i>Satin Aluminum</i>	
AR4550L-01-130	LH/LHR
AR4550R-01-130	RH/RHR

**4550 Cam Assy Kit**



AR 91-0752

**4568 Eurostyle Deadlatch Handles**

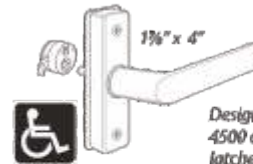

1 3/8" x 4"  
Designed to operate 4500 or 4700 Series latches (except 4750)

<i>Bronze Aluminum</i>	
AR4568-501-121	L.H., Center
AR4568-601-121	R.H., Center
<i>Satin Aluminum</i>	
AR4568-501-130	L.H., Center
AR4568-601-130	R.H., Center

**EXIT INDICATOR**



**FEATURES:**

- Includes two permanent adhesive header signs

<i>Bronze Aluminum</i>	
AR4089-00-121	
<i>Satin Aluminum</i>	
AR4089-00-130	



**4590 DEADLATCH PADDLES**  
*(for 4500, 4700, or MS+1890 Series)*



**FEATURES:**

- Includes cam plug

<i>Bronze</i>		
AR4590-01-00-313	Pull To Left	
AR4590-02-00-313	Push To Left	
AR4590-03-00-313	Pull To Right	
AR4590-04-00-313	Push To Right	
<i>Aluminum</i>		
AR4590-01-00-628	Pull To Left	
AR4590-02-00-628	Push To Left	
AR4590-03-00-628	Pull To Right	
AR4590-04-00-628	Push To Right	

**OPERATION**

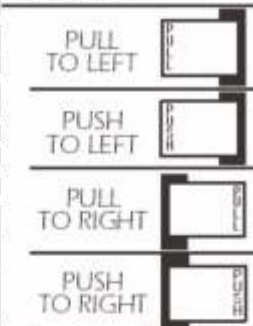

**4591 DEADLATCH PADDLES**



**FEATURES:**

- **Paddle Dogging**  
Turning hex key in escutcheon holds the paddle down, leaving door free swinging. (dogging key provided)
- Includes cam plug

<i>Bronze</i>		
AR4591-02-00-313	Push To Left	
AR4591-04-00-313	Push To Right	
<i>Aluminum</i>		
AR4591-02-00-628	Push To Left	
AR4591-04-00-628	Push To Right	

**Hex Key (for Dogging)**



AR 29-0481

**4591M MONITOR SWITCH PADDLE**



**FEATURES:**

- 4591 paddle without latch drive mechanism, but with switch that can be wired to make or break a low voltage circuit

<i>Bronze</i>	
AR4591M-02-00-313	Push To Left
AR4591M-04-00-313	Push To Right

SLIDING DOOR HARDWARE

Deadlock-Wood Doors

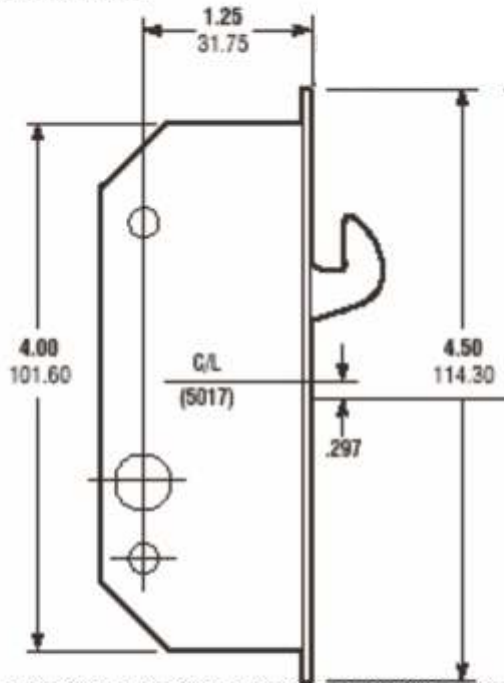

FEATURES:

- For wood framed sliding doors
- A deeper backset clears the recessed jamb used with wood doors

AR5017-00

Deadlock-Sliding Door

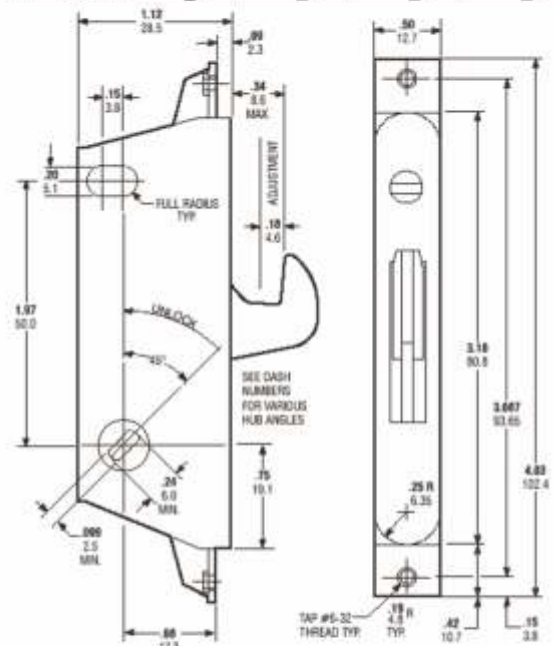

FEATURES:

- A compact lock to fit within very narrow sliding doors
- Stainless steel bolt is adjustable
- Full 3/16" lengthening or shortening of bolt projection is possible
- Self-protecting bolt will retract on contact with the jamb, thus preventing damage or accidental lock-out

ARMS1847-630



Deadbolt

FEATURES:

Heavy-duty deadbolt for metal or wood sliding doors, the 2331 throws a massive brass bolt into its strike, then expands two stainless steel dogs to secure the door

AR2331-626

Strike (for 1847)



FEATURES:

- With vertical adjustment and a shim system for horizontal
- Furnished with sheet metal screws for metal jamb installations

AR4801-01-603

Turn For 5017 (for use with cylinder pull)

FEATURES:

Satin silver enamel

AR1015-11-32-130



Turn (for MS1847)



AR1000-21-25-130

Cylinder Pulls (For 1847 and 5017)

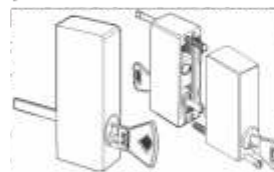

AR4025-06-01-130  
AR4026-06-01-130

Cyl not included (For 1847)  
Includes WR3 Cylinder (For 5017)



## EXIT DEVICES

### 8600 Series

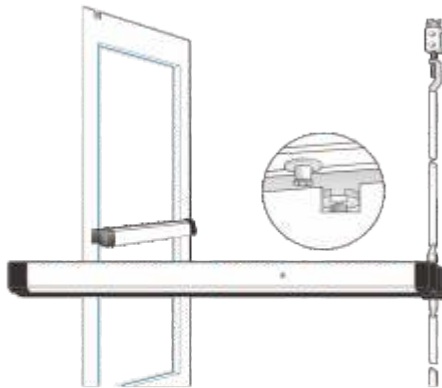

#### NARROW STILE CONCEALED VERTICAL ROD EXIT DEVICE FEATURES:

- Top and bottom adjustable steel rods
- Non-handed
- Lever Entry Trim is field reversible
- 36" (standard width bars can be field cut)
- Bar Height adjustable from 30" to 44"
- Door Height adjustable for doors up to 66" above the selected bar height
- 8655 Tall Door Kit
- Allows height up to 10'

#### *Satin Aluminum*

AR8611-36 CVR  
AR8611SE-36 Exit Device CVR/SE 628 Silent Electrification  
Use AR PS-SE Power Supply

#### *Dark Bronze*

AR8622-36-313 CVR  
AR8622SE-36 Exit Device CVR/SE 313 Silent Electrification  
Use AR PS-SE Power Supply

AR8655 Tall Door Kit For/8600



**AREX88-R628**  
Interlocking Rim Exit 36"  
**AREX89-M313**  
Pullman Rim Exit Device  
42"



#### **AREX89-M628**

Pullman Rim Exit Device 42"

#### **AREX89-R313**

Pullman Rim Exit Device 36"



#### **AREX89-R628**

Pullman Rim Exit Device 36"

### MONITORED DUMMY PUSHBAR

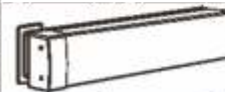

#### FEATURES:

- Latch replaced by a single monitor/signal switch

AR8099-M1-3136 "Active Dummy" (Aluminum)  
AR8099-M1-3236 "Active Dummy" (Bronze)

### 8700/8800 Series



#### Features:

- "Starwheel" Bolt interlocks door to frame

#### *Satin Aluminum*

AR8701-36 Wood & Hollow Metal Door  
AR8801-36 Alum Stile Glass Door  
AR8801-42 Alum Stile Glass Door

#### *Dark Bronze*

AR8802-36 Alum Stile Glass Door  
AR8802-42 Alum Stile Glass Door

#### ELECTRIC LATCH RETRACTION

#### Features:

- A solenoid mounted in pushbar for unlocking and locking from a remote location or access control device
- Fail-secure, this option can be used on fire-rated as well as life-safety applications

#### *Satin Aluminum*

AR8801EL-36-12VDC Rim Alum.  
AR8801EL-36-24VDC Rim Alum.

#### *Dark Bronze*

AR8802EL-36-12VDC Rim Alum.  
AR8802EL-36-24VDC Rim Alum.

### Series 8200

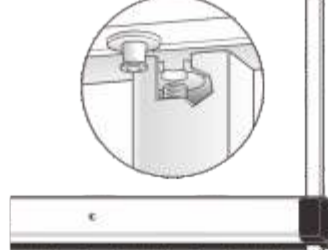

#### NARROW STILE SURFACE VERTICAL ROD

#### Features:

- Top latching mechanism interlocks door to frame
- Adjustable steel rods protected in contoured covers
- Non-handed
- Can be field cut
- Adjusts from 30" to 44"
- Fits up to 8ft. door, with bar height at 40" - 44". For doors up to 10ft., use Tall Door Kit 8055. (Not stocked)
- Thickness 1 3/8" x 2 3/4"
- Minimum 2" Stile

#### *Satin Aluminum*

AR8211-36 36" Aluminum

#### *Dark Bronze*

AR8222-36 36" Bronze

### 8400 Series



#### NARROW STILE MORTISE EXIT DEVICE

#### Features:

- Includes 4900 Deadlatch
- Handed
- 36" & 42" bars can be field cut to the next smallest opening width. Backsets available in 31/32", 1 1/8", 1 1/2"
- Suits 1 3/4" standard. Can be modified for thicker doors
- Minimum 2" Stile
- Standard dogging with hex key or cylinder dogging option

#### *Satin Aluminum*

AR8410-27136 RHR, 31/32" x 36"  
AR8410-37136 RHR, 1 1/8" x 36"  
AR8410-38136 LHR, 1 1/8" x 36"

#### *Dark Bronze*

AR8420-27236 RHR, 31/32" x 36"  
AR8420-28236 LHR, 31/32" x 36"  
AR8420-37236 RHR, 1 1/8" x 36"  
AR8420-37242 RHR, 1 1/8" x 42"  
AR8420-38236 LHR, 1 1/8" x 36"  
AR8420-38242 LHR, 1 1/8" x 42"

**ELECTRIC STRIKES**

**7100 SERIES Complete**



**Features:**

- For deadlatch or cylindrical
- Fits into aluminum jamb (or opposing door) sections as shallow as 1 3/8"

AR7100-510-313-00	24DC
AR7100-510-628-00	24DC
AR7100-540-313-00	12DC/24AC
AR7100-540-628-00	12DC/24AC

**7140 SERIES**



**Features:**

- For cylindrical type latchsets
- Fits into jamb sections as shallow as 1 1/8"
- 12DC/24AC

AR7140-540-628-00

**7160 SERIES**



**Features:**

- For cylindrical type latchsets
- Fits into jamb sections as shallow as 1 1/8"
- 12DC/24AC

AR7160-540-628-00

**7240 SERIES**



**Features:**

- Fire Rated
- For cylindrical type latchsets
- Extremely compact mechanism fits into jamb sections as shallow as 1-21/32"

AR7240-510-630-00

**7100 SERIES**

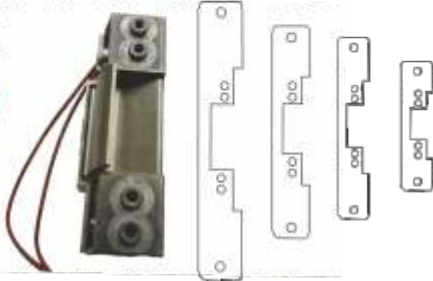

**Flat Profile 7100 Faceplate Kits Round Corner**

ARFPK00-313	1 3/4" x 4 7/8" Dark Bronze
ARFPK00-628	1 3/4" x 4 7/8" Sat. Aluminum
ARFPK30-313	1 3/4" x 6 7/8" Dark Bronze
ARFPK30-335	1 3/4" x 6 7/8" Black Anodized
ARFPK30-628	1 3/4" x 6 7/8" Sat. Aluminum
ARFPK10-652	1-7/16 x 7-15/16" Sat. Chrom.
ARFPK11-652	1-7/16 x 10 1/4" Sat. Chrom.

**- 4501 Retrofit -**

ARFPK45-313	1 3/4" x 6 7/8" Dark Bronze
ARFPK45-628	1 3/4" x 6 7/8" Sat. Aluminum

**Square Corner**

ARFPK40-313	1 3/4" x 4 7/8" Dark Bronze
ARFPK40-335	1 3/4" x 4 7/8" Black Anodized
ARFPK40-628	1 3/4" x 4 7/8" Sat. Aluminum

**Radius Profile 7100 Faceplate Kits Round Corner**

ARFPK01-313	1 3/4" x 4 7/8" Dark Bronze
ARFPK01-628	1 3/4" x 4 7/8" Sat. Aluminum
ARFPK31-313	1 3/4" x 6 7/8" Dark Bronze
ARFPK31-628	1 3/4" x 6 7/8" Sat. Aluminum

**7100 Strike Body Only**

Grade 1 - Field Reversible From Fail-Safe (FSA) to Fail-Secure (FSE)

**For Cylindrical and AR Latches - 5/8" throw**

AR7103A-315	12DC - FSA - 1/2"
AR7103A-515	24DC - FSA - 1/2"
AR7103A-310	12DC/24AC - FSE - 3/2"
AR7103A-340	12AC - FSE - 1/2"
AR7103A-410	16DC - FSE - 1/2"
AR7103A-440	16AC - FSE - 1/2"
AR7103A-510	24DC - FSE - 1/2"

Use FPK00 / FPK40

**For Mortise Latches up to 1 1/2" throw**

AR7173A-510 24DC - FSE - 3/4"

**SOLENOIDS for 7000 SERIES STRIKES**



**Solenoids Wire Color Chart:**

- 03: Black / Yellow
- 04: Black / Blue
- 05: Black / Red
- 06: Black / Green
- 07: Black / White

AR31-0044-03	12VAC INT
AR31-0044-04	16VAC INT
AR31-0044-05	12DC Cont./24 AC INT
AR31-0044-06	16VDC Cont.
AR31-0044-07	24VDC Cont.

**RITE TOUCH**

**DIGITAL GLASS DOOR LOCK**



ARRT1050D

**POWER SUPPLY For SE Devices**

**FEATURES:**

- Required for Electric Latch retraction

ARPS-SE  
Power Supply  
SE Devices  
ARPS-LR  
Power Supply  
LR Devices

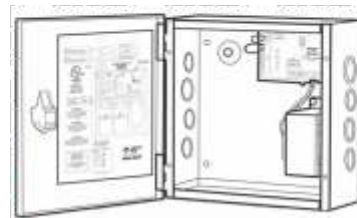



## ELECTRIC STRIKES

### ULTRALINE 7400 SERIES

#### Features:

- 7400 Strike bodies are 1" x 3 3/8" x 1 1/16" deep
- Field selectable to 12, 16V, or 24 VAC/DC
- Requires 16VDC adapter (VA7400-16VDC)

#### Complete 7400

Strikes For Cylindrical and Narrow Stile Deadlatches

#### ROUND CORNER

- |            |                |
|------------|----------------|
| AR7400-313 | Dark Bronze    |
| AR7400-628 | Satin Aluminum |

#### SQUARE CORNER

- |            |                |
|------------|----------------|
| AR7440-313 | Dark Bronze    |
| AR7440-628 | Satin Aluminum |

#### For Rim Exit Devices - 3/4" Throw

- |            |                |
|------------|----------------|
| AR74R1-313 | Dark Bronze    |
| AR74R1-628 | Satin Aluminum |

#### For Rim Exit Devices - 1/2" Throw

- |            |                |
|------------|----------------|
| AR74R2-121 | Dark Bronze    |
| AR74R2-130 | Satin Aluminum |

#### 7400 Strike Body Only

- |         |                             |
|---------|-----------------------------|
| AR7400A | Standard Flat Jamb Body Kit |
| AR7401A | Radius Stile Body Kit       |
- (use FPK7401 / FPK7431)

#### 7400 Options

- |                |                  |
|----------------|------------------|
| AR91-0933      | Shim Kit         |
| ARVA7400-16VDC | Option for 16VDC |
|                | (Required)       |
| ARWDC7400      | Wood Door Cover  |



7400



7440



7410-A



91-0933



DC7400



74R1 74R2



FPK7400



FPK7440



FPK7410



FPK7401



FPK7431

### Flat ProStle 7400 Faceplate Kits Radius Corner 1 1/4" x 4 7/8"

- |               |                |
|---------------|----------------|
| ARFPK7400-313 | Dark Bronze    |
| ARFPK7400-605 | Bright Brass   |
| ARFPK7400-628 | Satin Aluminum |

### Square Corner 1 1/4" x 4 7/8"

- |               |                |
|---------------|----------------|
| ARFPK7440-313 | Dark Bronze    |
| ARFPK7440-605 | Bright Brass   |
| ARFPK7440-628 | Satin Aluminum |

### Radius Corner 1 1/4" x 6 7/8"

- |               |                |
|---------------|----------------|
| ARFPK7430-313 | Dark Bronze    |
| ARFPK7430-628 | Satin Aluminum |

### Radius Corner 1 1/4" x 7 1/8"

- |               |                 |
|---------------|-----------------|
| ARFPK7410-313 | Dark Bronze     |
| ARFPK7410-630 | Stainless Steel |

### Radius Corner 1 1/4" x 10 1/4"

- |               |                 |
|---------------|-----------------|
| ARFPK7411-313 | Dark Bronze     |
| ARFPK7411-630 | Stainless Steel |

### Radius ProStle 7400 Faceplate Kits Radius Corner 1 1/4" X 4 7/8"

- |               |                |
|---------------|----------------|
| ARFPK7401-121 | Dark Bronze    |
| ARFPK7401-130 | Satin Aluminum |

### Radius Corner 1 1/4" X 6 7/8"

- |               |                |
|---------------|----------------|
| ARFPK7431-121 | Dark Bronze    |
| ARFPK7431-130 | Satin Aluminum |
| ARFPK7445-313 | Dark Bronze    |
| ARFPK7445-628 | Satin Aluminum |

## eFORCE SERIES

#### Features:

- Battery-operated keyless entry control for Adams Rite deadlatches and exit devices
  - Up to 150 users
  - Program on keypad
  - Operation is confirmed by both a visual LED light indicator and an audible sound generated by a piezo horn
- |               |  |
|---------------|--|
| AR3090-01-121 |  |
| AR3090-01-626 |  |



## DUAL FORCE SERIES

#### Features:

- Interconnected deadbolt and deadlatch operate with a single motion release
- Meets all building code egress requirements
- Re-handable, clutched exterior lever trim
- Retrolts to MS<sup>®</sup> prepped doors
- Key controlled extension of deadbolt and latch holdback
- Electrified lever option for access control



Strike Elec Surf MT Starwheel  
AR7800-613E  
AR7800-630

## 4300 SERIES

#### Features:

- Fail Secure
  - 12, 16 or 24 volt DC power
  - Rated for continuous duty
  - Interchangeable with MS<sup>®</sup> Deadbolts or 4500/4900 Deadlatches
- |                   |        |
|-------------------|--------|
| AR4300-20-101-313 | 31/32" |
| AR4300-20-101-628 | 31/32" |
| AR4300-30-101-313 | 1 1/8" |
| AR4300-30-101-628 | 1 1/8" |



## DUAL FORCE DEADBOLT

- |                    |                 |
|--------------------|-----------------|
| AR2190-311-101-32D |                 |
| AR2190-312-101-10B |                 |
| AR2101-02-121      | Strike - Bronze |
| AR2101-02-630      | Strike - SS     |
| AREK-2190          | ELECTRIFICATION |



2190





2190-312-101



2101-02



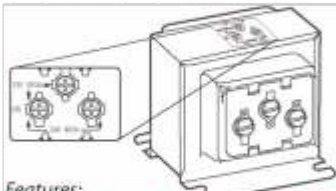
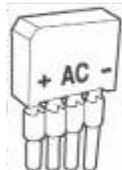





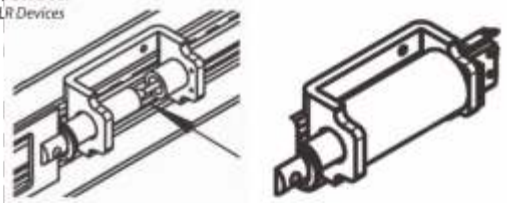







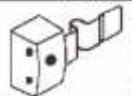



**ELECTRIC HARDWARE**

<p><b>Transformer</b></p>  <p><b>Features:</b></p> <ul style="list-style-type: none"> <li>• Converts 120VAC to 12VAC/24VAC. 40 Volt-amp output</li> </ul> <p>AR4605</p>	<p><b>Rectifier</b></p>  <p><b>Features:</b></p> <ul style="list-style-type: none"> <li>• Converts low voltage AC current to DC of same voltage</li> <li>• Installs between transformer and strike</li> <li>• Full wave bridge type</li> <li>• Rated 2 amps (200PW)</li> </ul> <p>AR4603</p>	<p><b>Wire Transfer</b> 105° Door Swing</p>  <p><b>Features:</b></p> <p>Suitable for any door hung with butt-type hinges, including continuous or pivots offset 3/4" or less (Not compatible with center-pivot doors)</p> <p>AR4612-1</p>
--	---	--

**EXIT DEVICES PARTS**







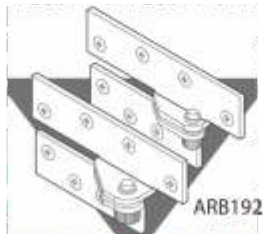

























<p><b>MONITOR SWITCH</b></p>  <p>FOR "M" AND "MM" EXIT DEVICES (AND KITS FOR CONVERSION OF NON-M BARS)</p> <p><b>Features:</b></p> <ul style="list-style-type: none"> <li>• Retrofit to existing Adams Rite exit devices (including old monitored bars)</li> <li>• Switches can be wired normally open or normally closed to either make or break a circuit when bar is pushed</li> </ul> <p>AR91-0897-01 Single Conversion AR91-0897-02 Double Conversion</p>	<p><b>Solenoid</b> For LR Devices</p>  <p>For CVR 3600, 3900, 8500, 8600, 8900 For SVR 3100, 8100, 8200</p> <p>AR31-0833-IP Solenoid for LR Devices AR31-0117-IP 2Wire Driver Board LR Devices</p>
---	--

 <p><b>AR24-0730</b> Dogging Key Shaft - Metal, 92-95</p>	 <p><b>AR25-0471-IP</b> Plastic End Cap Hinge Side, 3000 &amp; 8000 Series</p>	 <p><b>AR25-0506-MP</b> Bolt Guide Bushing</p>
 <p><b>AR25-0480</b> Dogging Key- Plastic</p>	 <p><b>AR41-0903-IP</b> Metal End Cap Hinge End, All Devices</p>	 <p><b>AR31-0964-IP</b> Bolt Guide Assy 8600</p>
 <p><b>AR29-0480</b> Dogging Key - Metal, 92-95 5/32"</p>	 <p><b>AR41-0801-01-IP</b> 83-84-8600 Series</p>	 <p><b>AR 31-0265-IP</b> Dogging Assy "Only" 8000 Series</p>
 <p><b>AR29-0481</b> Dogging Key 1/8" - 95-</p>	 <p><b>AR41-0801-08-IP</b> 87-8800 Series</p>	 <p><b>AR25-0062-01-MP</b> Spider (10pk)</p>
 <p><b>AR31-0944-IP</b> 8600 Actuator Assy (top)</p>	 <p><b>AR41-0902-03-IP</b> 3700, 8700, 8800 Series</p>	 <p><b>RETROFIT KITS</b> Includes dogging assembly, 2-keys, drilling template, 7/32" drill bit and installation instructions</p> <p>AR91-0956-01 8100/8200 AR91-0957-02 8300/8400/8500/8600 AR91-0958-03 8700/8800</p> <p>☐ Dogging assembly not included</p>
 <p><b>AR31-0945</b> Strike Top For 8600 Series</p>	 <p><b>AR41-0902-04-IP</b> 3100, 8100, 8200 Series</p>	
 <p><b>AR41-0827-02</b> Bolt Guide 4015 • 1870 • 1860</p>	 <p><b>AR41-0902-05-IP</b> 3700, 84, 85, 86, 8099M</p>	
 <p><b>AR91-0240</b> Header Strike</p>		

**B1923 REINFORCING PIVOTS**

 <p>ARB1923</p>	<p><b>Features:</b></p> <ul style="list-style-type: none"> <li>• Full surface reinforcing pivots for push doors</li> <li>• Zinc plating over steel</li> <li>• 3/8" to center line of 4 1/2" hinge</li> <li>• Pin uses large pin and bushing</li> <li>• Non-Handed</li> </ul>
--	--

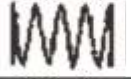
MISCELLANEOUS PARTS

<p><b>Header Sign</b></p> <p><b>THESE DOORS MUST REMAIN UNLOCKED</b></p> <p><b>DURING BUSINESS HOURS</b></p>	 <p><b>AR29-0546-MP</b> Pal-Nut</p>	 <p><b>ARFPK-4200-313</b> Elatch Faceplate Kit</p>
<p><b>AR20-0255-IP</b> <i>Unlocked During Business Hours</i></p> <p><b>AR20-0256-IP</b> <i>Unlocked While Building is Occupied</i></p>	 <p><b>AR31-0079-MP</b> 4591 Set Screw • Package of 10 • 3/8-20 x 1 1/4 Multi-Pak</p>	 <p><b>CYLINDER GUARDS</b> Guard-5 Or 6 Pin Cyl Features: • Grip/Twist Resistant • Pry Resistant • Internal Door Reinforcement <b>ARMS4043-00-121</b> <b>ARMS4043-00-130</b></p>
<p><b>AR22-9076</b> eForce Mounting Bracket</p>	 <p><b>4580 Cam Discs</b> Features: • Handing reversible <b>AR4580-500 L.H.</b> <b>AR4580-600 R.H.</b></p>	 <p><b>AR5194-06R08-603</b> Screw For 4560</p>
 <p><b>AR23-0154-IP</b> Latch Actuator</p>	 <p><b>AR7400-M-628</b> Electric Strike Monitored</p>	 <p><b>ARS232B8-9/32N-631</b> Set Screw 9/32"</p>
 <p><b>AR24-0384-020-313</b> Faceplate - Flat Shrt H/BLT</p>	<p><b>AR74R1-121</b> Ultraline Electric Strike</p>	 <p><b>ARS232C08-05-631</b> Set Screw 3/8"</p>
 <p><b>AR26-0055</b> Paddle Shaft</p>	 <p><b>AR74R1-130</b> Ultraline Electric Strike</p>	 <p><b>ARS232C8-15/32-631</b> Set Screw 15/32"</p>
 <p><b>AR26-0188-09</b> Binder Post AR26-0488-MP 4591 Binder Post 10/Pack</p>	<p><b>CYLINDER ESCUTCHEONS</b></p>  <p>AR8650-313 Bronze AR8650-628 Aluminum</p>	 <p><b>ARS235-08R04-119</b> Alum Faceplate Screw</p>
 <p><b>AR26-0398N</b> Set Screw For 4590</p>	 <p><b>AR91-0060</b> Spring Kit Paddle, 4590 &amp; 4780</p>	 <p><b>ARS235-08R04-603</b> Alum Faceplate Screw</p>
 <p><b>AR28-0061</b> Spring For 4710 Latch Arm</p>	 <p><b>AR91-0992-02</b> 8800 Frame Kit</p> <p><b>AR91-8800</b> 87/8800 Loose Parts</p>	 <p><b>ARS236-08R14-603</b> Binder Post Screw</p>
 <p><b>AR28-0062</b> Spring For 4710 Bolt</p>	 <p><b>AR91-0993</b> 8800 Strike Kit For center hung doors with 4" jam</p>	
<p>AR28-0063 Spring For 4710 Aux Bolt AR28-0064-02 Spring For MS Lock</p>	 <p><b>AR91-8800</b> 87/8800 Latch/Link Kit</p>	
 <p><b>AR28-0064-03</b> Spring For MS Lock</p>		
 <p><b>AR28-0070</b> Retainer Spring For Paddle</p>		
 <p><b>AR28-0117</b> Spring Eurostyle 4568</p>		
 <p><b>AR28-0150-MP</b> Spring Shuttle Return</p>		
 <p><b>AR28-0151-MP</b> Spring Blocking Arm Return</p>		
 <p><b>AR28-0225</b> Spring 4560</p>		



## MVP SYSTEM & PARTS

### MVP-PRO SYSTEM

The MVP System (Multi-Vehicle-Programmer) is the first fully functional transponder key programmer sold at an extremely low initial buy-in price and used by the locksmith on a Pay-Per-Use basis, using "Program Tokens".



Smart Pro  
AVMVP-PRO Multi Vehicle Programmer  
• Software and Program Tokens are available  
Ask your sales representative for more info.



### REPLACEMENT PARTS & DONGLES

- |           |  |
|-----------|--|
| AVADC-167 | Dongle "K" Brown Adapter                     |
| AVADC-173 | Replacement "J" Dongle for the Pro "Purple"  |
| AVADC-191 | Toyota Prius "M" Dongle for the Pro "Orange" |
| AVADC-250 | Replacement Main Cable                       |
| AVADA103  | Smart Card Calculator                        |
| AVADA104  | Replacement Smart Card                       |
| AVADC-193 | Hyundai and Kia Remote Programming Cable     |
| AVADC-199 | Pin Saver Adapter                            |
| AVADC-240 | Smart Dongle                                 |
| AVADS-139 | Software GM Can                              |

## TESTERS & TOOLS



AVAD-35

### TRANSPONDER COIL & REMOTE DETECTOR

To assist with the diagnosis of all types of IR/ Infra Red and RF Radio Frequency remote controls.



# A

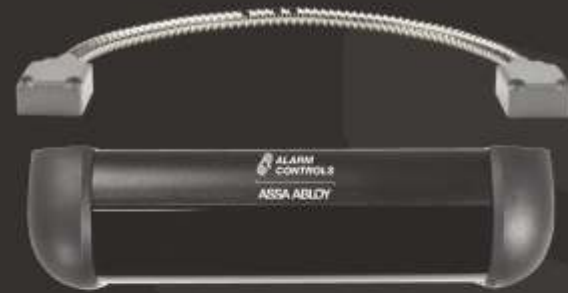

# Z

## And Everything In Between.

From standard push buttons to custom elephant buttons, Alarm Controls is your one-stop shop for design, test, build and technical knowledge. With a minimum order quantity of ONE, let Alarm Controls create a custom product or solution for virtually any application you need or can dream up!

Contact the **Custom Solutions** team at **800.645.5538** or email us at **custom.alarmcontrols@assaabloy.com** for simple solutions to complex problems.

**AlarmControls.com**



ASSA ABLOY, the global leader  
in door opening solutions

**MAGNETIC LOCKS**

**AC600S**  
600 lbs Single Lock



- 600 lbs maximum holding force
- Magnet size: 9 7/8" L x 1 7/16" H x 1" W
- UL listed to UL 10C, ULC listed to ULC-S104 (Canada)
- 12 or 24VDC, selectable
- Recommended for interior doors

**AC1200S**  
1200 lbs Single Lock



- 1200 lbs maximum holding force
- Magnet size: 10 1/2" L x 2 7/8" H x 1 1/2" W
- UL listed to UL 10C, ULC listed to ULC-S104 (Canada)
- 12 or 24VDC, selectable
- Recommended for exterior doors

**AC600LB**  
600 lbs Single Lock with Bond Sensor, Door Status Sensor and LED

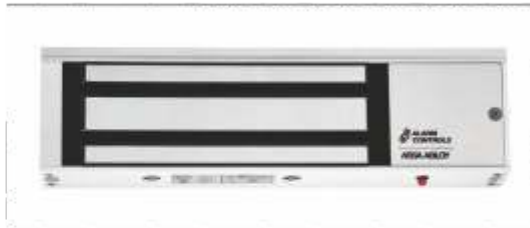

- 600 lbs maximum holding force
- Magnet size: 9 7/8" L x 1 7/16" H x 1" W
- UL listed to UL 10C, ULC listed to ULC-S104 (Canada)
- Bi-color status LED, SPDT 3A relay contact rating
- Recommended for interior doors

**AC1200LB**  
1200 lbs Single Lock with Bond Sensor, Door Status Sensor and LED



- 1200 lbs maximum holding force
- Magnet size: 10 1/2" L x 2 7/8" H x 1 1/2" W
- UL listed to UL 10C, ULC listed to ULC-S104 (Canada)
- Bi-color status LED, SPDT 3A relay contact
- Recommended for exterior doors

**AC600D**  
600 lbs Double Lock



- 600 lbs maximum holding force per lock
- Magnet size: 19 3/4" L x 1 3/8" H x 1" W
- UL listed to UL 10C, ULC listed to ULC-S104 (Canada)
- 12 or 24VDC, selectable
- Recommended for interior doors

**AC1200D**  
1200 lbs Double Lock with Bond Sensor, Door Status Sensor and LED



- 1200 lbs maximum holding force per lock
- Magnet size: 21" L x 2 7/8" H x 1 1/2" W
- UL listed to UL 10C, ULC listed to ULC-S104 (Canada)
- Bi-color status LED, SPDT 3A relay contact rating
- Recommended for exterior doors

**MAGNETIC LOCK MOUNTING BRACKETS**

**ACAM3315  
MAGNETIC LOCK**

*Armature Housings and Mounting Plates*



- For use on extra thick doors
- For use on glass doors with frames
- AM3315 for 600 and 1200 Series locks

**ACAM3300 / ACAM6300  
DROP DOWN PLATES**

*for Single Locks*



- AM3300 1/2" plate for 600 lbs lock
- AM6300 1/2" plate for 1200 lbs lock

**ACAM3370  
ACAM6370  
Z BRACKETS**

*for Magnetic Locks*



- AM3370 for all 600 lbs single locks
- AM6370 for all 1200 lbs single locks

**ACAM6361  
FILLER PLATE**

*for Magnetic Locks*



- Use to widen door stop
- AM6361 Filler Plate 10 1/2" L x 3/4" W x 1/2" H

**ACCESSORIES**

**ACRT-1**

**WIRELESS TRANSMITTERS AND RECEIVERS**

- Receiver operates on 12 or 24 volts AC or DC, maximum current 50 mA
- SPDT relay with 1A @ 30 VDC or 120 VAC contacts
- Receiver has 1/2 second momentary output. User programmable option for latching output
- 433.92 MHz working frequency
- Rolling code, more than one billion code combinations
- Receiver will accept up to thirty transmitters
- Receiver has a small size 2 1/2" L x 1 1/4" W x 3/4" D with an attractive off-white case
- Receiver screw terminals are hidden by cover
- Bi-color LED on receiver indicate condition of relay
- Receiver has a 12" long thin wire antenna for maximum range of 300 feet
- Two transmitters are supplied with each receiver
- A unique transmitter holder can be mounted under a desk or on a wall
- One transmitter has a keychain; additional transmitters are available (part number RT-1T)





**ACCESSORIES — continued**

**ACDL-2**

**ARMORED DOOR LOOPS**

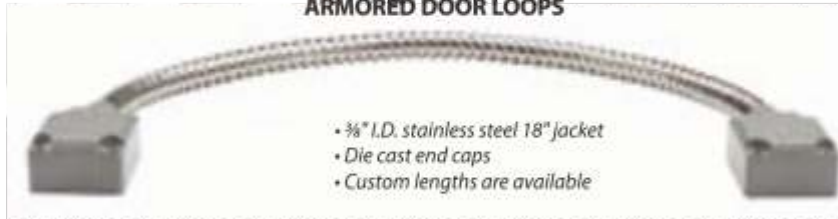

- 3/8" I.D. stainless steel 18" jacket
- Die cast end caps
- Custom lengths are available

**ACSREX-100**

**ACTIVE FOCUSED INFRARED**

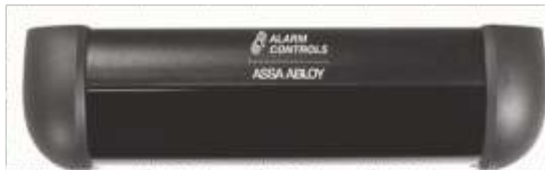

- UL 294 ULC-5319 listed as an access control device
- Narrow activation zone is limited to the door handle area
- Designed to eliminate cross traffic activation
- Cannot be deceived by placing objects under the door
- Easy installation and adjustable depth zone
- Operates on 12/24VAC or VDC auto sensing
- Maximum current draw is 155mA sounder on, 200mA sounder off
- Temperature range for UL installations is +32°F to +120°F, (0°C to +49°C)
- Double pole – double throw contacts (2 form C)
- Relay contact rating is 1.3A @ 30VDC or 24VAC
- Adjustable time delay from one to sixty seconds
- Built-in buzzer can be silenced if required
- REX input, keypad or card reader input and door position switch input
- 14 pin female connector with four feet of cable
- Three year warranty

**REQUESTS TO EXIT STATIONS**

**ACTS-2**



- 2" square LED illuminated button operates on 12 or 24VDC
- SPDT momentary switch
- Contacts rated 1A @ 35VDC
- UL listed to UL 294
- 1 1/2" mounting depth
- Model TS-2-2 provides an additional SPDT momentary output

**ACTS-2T**



- Same specifications as TS-2
- Contacts rated 1A @ 35VDC
- UL listed to UL 294
- 1 1/2" mounting depth
- 2 to 45 second adjustable timed SPDT output
- Model TS-2-2T provides an additional SPDT momentary output

**ACDE-1**



Delayed Egress Station  
12/24 VDC 2-30 Second Delay

**ACNTS-1**

No-Touch Switch Dual Color Red

**ACTS-2-2**

U.L. 2" Sq. Green Illuminated

**PNEUMATIC TIME DELAY EXIT RELEASE STATIONS**

**ACTS-14**



- 1 1/2" diameter green mushroom button
- N/O and N/C contacts rated 10A @ 35VDC
- Time range 20-60 seconds
- Single gang stainless steel plate

**ACTS-60**



- 2 1/2" diameter red mushroom button
- N/O and N/C contacts rated 10A @ 35VDC
- Time range 2-60 seconds
- Single gang stainless steel plate

**ACEB-1  
EGRESS PUSHBUTTON**



- 1 1/2" diameter red mushroom button
- Momentary switch
- Contacts rated 10A @ 35VDC or 120VAC
- One N/O and one N/C contact
- Mounted on single gang stainless steel wall plate

**ACTS-17  
KEY CONTROLLED DOOR RELEASE**



- One N/O and one N/C contact, rated 10A @ 35VDC or 120VAC
- Black ABS plastic box with mounting ears

**ACTS-18  
DOOR RELEASE**



- Momentary action pushbutton
- SPDT contacts, 4A @ 28VDC
- Button protected with guard ring
- Black ABS plastic box with mounting ears

**ACREB-1  
REQUEST TO EXIT PUSHBAR**



- REB-1 measures 34 1/2" in length. REB-3 measures 48" in length
- Low profile design, 2 1/2" wide x 2" high
- Low operating force, minimal bar travel
- Four SPDT switches for positive redundant operation
- 18" armored door loop included with changeable white and brown end caps
- Field reversible and easily installed on all types of doors
- Heavy duty clear anodized satin aluminum construction
- Available in Duronic Inish, part number REB-1DURO or REB-3DURO

**LOCK-N-BOX**

**ACLNB-12**



Lock-N-Box with 1200s  
Mag Lock KP-400  
Weatherproof Keypad

**ACLNB-6**



Lock-N-Box with 600s  
Mag Lock KP-100  
Backlit Digital Keypad



**SELF-CONTAINED DIGITAL KEYPADS**

**ACKP-100  
DIGITAL KEYPAD**



- Programmable from the keypad
- Operating voltage 12 or 24 VAC/VDC
- Backlit hard plastic keys
- SPDT 5A contacts
- 100 user codes
- Code length from 4 to 8 digits
- Request to exit input
- Audible and visual key press
- 302 stainless steel wall plate
- Can be surface or flush mounted
- LED status indicators
- False code lockout
- Keypad buzzer can be silenced
- Designed for indoor use only
- Many more additional features

**ACKP-200  
WEATHERPROOF KEYPAD**



- Programmable from the keypad
- Operating voltage 12/24VAC or VDC
- Backlit metal keys
- SPDT 5A contacts
- Output 1: 100 user codes code length 4 to 8 digits
- Output 2: 10 user codes code length 4 to 8 digits
- Request to exit input, duress output
- Audible and visual key press
- Vandal resistant metal housing
- Can be flush mounted
- LED status indicators
- False code lockout
- Built-in buzzer and tamper switch
- Designed for indoor or outdoor use
- Many more additional features

**ACKP-300  
MULLION MOUNT VANDAL  
RESISTANT KEYPAD WITH  
BUILT-IN CARD READER**



- Programmable from the keypad
- Operate 12VDC nominal, 11-15VDC
- Die cast zinc alloy housing
- Two programmable SPDT relays
- Operate with user code, card or code & card
- Output 1: 1000 user codes & cards
- Output 2: 100 user codes & cards
- Die cast, backlit, metal keys
- LED status indicators
- 50 visitor codes, programmable for one-time use or with time limit
- False code lockout
- Built-in buzzer and tamper switch
- Can be used indoors or outdoors
- Model EM-10 is a package of 10 additional cards

**ELECTRIC DOOR STRIKES**

**ACKP-400  
VANDAL RESISTANT KEYPAD**



- Programmable from the keypad
- Operating voltage 12/24VAC or VDC
- Backlit metal keys
- Two programmable relay outputs
- Output 1: 100 user codes code length 4 to 8 digits
- Output 2: 10 user codes code length 4 to 8 digits
- Request to exit input, duress output
- Audible and visual key press
- Die cast back box
- 302 stainless steel front plate
- LED status indicators
- False code lockout
- Built-in buzzer can be silenced
- Designed for indoors or outdoors

**ACAES-100**

**BHMA GRADE 1 DUAL VOLTAGE ELECTRIC STRIKE**

- BHMA Grade 1
- UL 1034 Burglary Resistant, 1500 lbs static strength
- Static strength 70 ft-lbs. Dynamic strength endurance rating 500,000 UL tested, 1,500,000 factory tested
- Strike depth 1 1/2"
- Field selectable, fail secure/fail safe
- Dual voltage 12/24 VAC or VDC, continuous duty operation on DC

- Fully reversible for right or left hand doors
- Mounting kit includes two 4 7/8" stainless steel face plates (one round corner and one square corner)
- Current draw 12VAC 130mA, 24VAC 70mA
- Current draw 12VDC 210mA, 24VDC 105mA



**ACAES-200**

**BHMA GRADE 2 DUAL VOLTAGE ELECTRIC STRIKE**

- BHMA Grade 2
- 1000 lbs static strength
- Factory cycle tested to 500,000 cycles
- Strike depth 1 1/2"
- 3/8" throw
- Adjustable keeper
- Strike monitored with SPDT (1 form C), dry contacts
- Field selectable, fail secure/fail safe
- Universal 12 through 24VAC or VDC input

- Fully reversible for right or left hand doors
- Mounting kit includes two 4 7/8" stainless steel face plates (one round corner and one square corner)
- Horizontally adjustable and pre-load capable
- Built-in buzzer, sounds when voltage is applied
- Current draw 12VAC 200mA, 24VAC 70mA



**ACAES-300-12V-KIT  
ACAES-300-24V-KIT**

Electric Strike 12VDC Grade 2  
Electric Strike 24VDC Grade 2





# networkx wireless access control solutions... about 1/2 the cost, on any door

- Broadest line, simply retrofits standard locksets on every door and application, inside & out
- Wireless Trilogy® Networkx®, Grade 1, advanced access networked locks, managed with free AL Scheduling & Database Software or real-time software platforms
- Wireless Networkx ArchiTech® Series Grade 1, advanced network locks with thousands of architecturally-pleasing finish, style & function combinations & iLock® Mobile App
- Campus/university/K-12 lockdown solutions
- Integrated with enterprise access control partners:
  - Continental Access CA4K®
  - Lenel® OpenAccess Alliance®
  - Software House® Connected Partner Program®

Ask for Networkx at your distributor or call us



1.800.ALA.LOCK • www.alarmlock.com

-  **MORE AFFORDABLE**  
Lowest labor & equipment costs without sacrificing top conventional access features
-  **EASY INSTALL**  
Replaces any door lock, on any door type, neatly, quickly
-  **EASY NETWORK**  
No wires to run to doors. Uses customers' existing network or Ethernet & multi-lock gateways & optional repeaters
-  **USERS**  
Supports thousands of PIN, ID or iLock App users. Easily added/removed local or remotely
-  **GLOBAL LOCKDOWN**  
or unlock in seconds from the server or any lock
-  **CENTRALLY MANAGED**  
Auto-Schedule program updates, queries, or free access by time, by door & more



Trilogy, Network, ArchiTech, Lock, Continental & CA4K™ are trademarks of Alarm Lock, a Division of Napco.  
\*\*Lenel OpenAccess Alliance™ is a trademark of UTC. \*Connected Partner Program & Software House™ are trademarks of Tyco.

## TRILOGY® DIGITAL LOCKS



### DL 2700 SERIES

- Three security levels of control. Up to 90 user codes
- Grade 1 - UL Listed, fire rated 3 hours
- 6 pin cylinder, SC1 keyway
- 5 AA alkaline batteries (included)
- All functions programmed through keypad
- 2 3/4" Backset (2 3/8" latch available); 1 1/8" to 1 3/4" door thickness

ALDL2700-US10B  
 ALDL2775IC-26D-S  
 ALDL2700CRL-US26D  
 ALDL2700CRR-US26D  
 ALDL2700IC-C-US26D  
 ALDL2700ICUS26D  
 ALDL2700WP-US26D  
 ALDL2700US26D  
 ALDL2700US3

Oil Rubbed Bronze, Lever  
 T2 Schlage LFIC Prep  
 T2 Trilogy Mortise Lock LH  
 T2 Trilogy Mortise Lock RH  
 T2 Trilogy Corbin IC Prep  
 T2 Trilogy SFIC Prep Needs  
 T2 Trilogy Weatherproof  
 T2 Trilogy Cylindrical  
 T2 Trilogy Cylindrical



### PDL1300 SERIES Narrow Stile Pin/Prox Lever for AR Latch

- 3-6 digit PIN codes
  - non-handed
- ALPDL1300/26D1  
 (Includes Prox reader)



### DL1200/1300 SERIES Narrow Stile Lever for AR Latch

- 3-6 digit PIN codes
  - non-handed
- ALDL1200/10B1 T2 Trilogy NS Lever for AR  
 ALDL1200/26D1 T2 Trilogy Narrow Stile  
 ALDL1300/10B1 T3 Trilogy NS Lever for A.R.  
 ALDL1300/26D1 T3 Trilogy NS Lever for A.R.  
 (Does not include Prox reader)

## TRILOGY® T3

ALDL2800-US26D T3 Trilogy Cylindrical  
 ALDL2800IC-US26D T3 Trilogy SFIC Prep  
 ALDL3000WP-US26D T3 Trilogy Weatherproof  
 ALPL3000-US26D T3 Trilogy Prox No Keypad  
 ALDK3000-MS T3 Trilogy Digital Keypad AL-  
 DL4100-US26D T3 Trilogy Privacy/Residency  
 ALPDL3500CRR-US26D T3 Trilogy Prox Mort Lock RH  
 ALPDL3000-US26D T3 Trilogy Digital Prox



## PDK 3000



### PDK3000

Standalone Keypad/Proxy Reader

- Features:
- 2000 pin codes/HID cards or fobs
  - Wall mount or single gang box
  - 2 high-current relays
  - Keypad or PC programmable
  - 40,000 event audit trail
  - 500 scheduled events
  - Weatherproof
  - REX

ALPDK3000-MS  
 ALPDK3000-US26D

Metallic Silver  
 Dull Chrome



## TRILOGY® EXIT TRIM

### TRILOGY EXIT TRIM Add Trilogy® Convenience & Audit Trail To Panic Exit Devices from Most Major Manufacturers

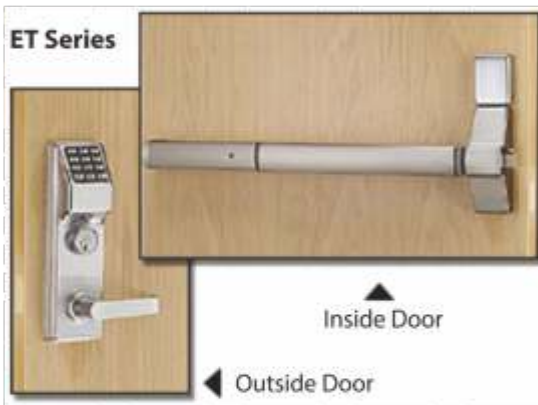

- Compatible with: Von Duprin 99, Corbin ED5000, Yale 7100, Dorma 9300, Arrow 3800, Sargent 8800, Precision 1100, 2200 & Cal Royal 9800 series panic devices.
- Available in DL series (keypad) or PDL (prox/keypad) formats.
- 2,000 user codes, 500 scheduled events and 40,000 event audit trail
- Fingertip and/or Windows programmable
- Weather-Resistant performance
- Uses standard rim cylinder to operate key override function
- Non-handed

#### Trims

ALETDL51G/26DV99  
 ALETPDL51G/26DV99  
 ALET-BIC-26D  
 ALET-SK-26D  
 ALETDL2751G26DN88  
 ALETDL2751G26DS88  
 ALETDL2751G26DV99

T3 Trilogy Exit Trim VD 99  
 T3 Trilogy Exit Trim VD 99  
 Adapter Kit Best IC 6/7P  
 Adapter Kit Schlage IC  
 T2 Exit Trim New Sargent 8888  
 T2 Exit Trim Old Sargent 8800  
 T2 Exit Trim Von Duprin 99

## NETWORKX

These Trilogy locks communicate wirelessly to a single Gateway (each gateway controls up to 63 locks), networked to any non-dedicated Windows PC.



#### Features:

- Ethernet or 802.11B/G wireless communication
- Hosted on free Alarm Lock DL-WINDOWS software - Original and •••• Networkx Trilogy locks can share one common database
- PDL6100 has built-in Prox Reader
- Weatherproof
- Non-Handed
- 3 hour UL fire-rated deadlatch
- Door thickness: 1 1/2" - 1 3/4"
- 2 3/4" backset standard (2 1/2" latch available)

#### TRILOGY NETWORKX

AKNETWXSTARTER  
 AKNETPDKPAK-26D  
 ALALPCI2-U  
 AKAL-IM80211  
 AKAL-IME  
 AKAL-IME2-EXP  
 AKAL-IME2  
 AKNETPDK-260  
 AK56196

Wireless System-In-A-Box  
 Networkx Keypad Pak  
 USB Computer Interface Cable  
 Networkx Wi-Fi Gateway  
 Networkx Ethernet Gate  
 Networkx Wireless Expander  
 Networkx Ethernet Gate V2  
 Networkx Digital/Prox Keypad  
 Networkx Battery Pack

#### PDL1300 SERIES

AKPDL1300NW-10B1  
 AKPDL1300NW-26D1

Networkx Narrow Stile Prox  
 Networkx Narrow Stile Prox

#### DL6100 SERIES

AKDL6100-26D  
 AKDL610026DUPGRD  
 AKDL6100IC-26D

Networkx Cylindrical LK  
 Networkx Upgrade Kit  
 Networkx Digital Lock

#### PDL6100 SERIES

AKPDL6100-26D  
 AKPDL610026DUPGRD  
 AKPDL6100IC-26D

Networkx PRX/Digital CYL  
 Networkx Upgrade w/PROX  
 Networkx PROX/Digital

#### PDL6500 SERIES

AKETPDNS1G26DV99

Networkx Mortise PROX

Digital W/Prox

AKPDL6500CRR-26D



**MISC PARTS**

**Laptop Computer Interface Kit**

*Includes DL-Windows*



PC-Interface Cable connects lock and PC for up/downloaded data transmission (programming & audit trail info). The audit software necessary to download audit trail for the following: DL 2800, DL 3000, DL 4100, PDL 3000, AND PDL 3500 - but not the DL 2700.

**ALAL-PCI2 Laptop Computer Interface Serial Connector**

**Data Transfer Module**



- Stores data for up to 96 locks for transfer to/from PC

**ALAL-DTMIII**

ALS5980-1  
ALS6148  
ALALHID1326  
ALALHID1346  
ALP5849-US26D  
ALS6045

Latch 2 3/4" US26D  
Lever Spring Repl Kit  
Proximity Access Cards  
Proximity Keyfob  
2 3/4" Latch DL2700/3000/PDL3000  
Key Override Lock Body

ALS6061  
ALS6175  
ALS6184  
ALS6065  
ALMX1130  
ALHW1347  
ALHW621E

Battery Pack DL 2700  
Lever Spring Mortise Lock  
Lever Set Screw Pkg  
Battery Pack Mortise  
USB Adapter Kit  
MEDECO IC CAM DL1200/1300  
TAILPIECE SCHILAGE K.O.



**ALRR-1BUTTON**



**ALRR-4BKEYFOB**

ALRR-1BUTTON  
ALRR-4BKEYFOB  
ALRR-RECEIVER  
ALRR-TRILOGYKIT

Remote Release Desk Mount Button  
Remote Release 4-Button Keyfob  
Receiver, install next to battery pack  
Remote Release Kit

**SIREN LOCK EXIT DOOR ALARMS**



**AL710-US28 Exit Device w/Alarm**

- Features*
- Cylinder not included
  - 9v battery included
  - Blaring 95db dual tone siren
  - Selectable 2-minute alarm or constant alarm
  - Meets or exceeds UL, CFM, ADA, NYC housing
  - Non handed

**AL710-US28 Aluminum-33"**

**Model PG21**



- Features*
- Unauthorized use of door sounds alarm and activates LED indicator
  - Options include continuous alarm, 2 minute shutdown with auto reset and exit/entry delay
  - Uses standard mortise cylinder (not included)
  - For exterior control, optional RIM cylinder may be used
  - Cylinder not included

**ALPG21-MS Exit Alarm-Alarm**

**Model PG30**

*Narrow*



- Features*
- Digital codes for Master, Management and Passage (used for Auto-Arming)
  - 3 security levels for:
    - a) High Security
    - b) Unattended applications
    - c) Flexible control for delivery doors, etc.
  - 3 Programmable 95db siren styles: sweep, pulsed, and steady
  - Logo key is dual function test button

**ALPG30-MS Exit Alarm-Alarm**  
**ALPG30KPD Exterior Keypad**

## SOLID STEEL PADLOCKS

### Maximum Outdoor Security

**Features:**

- Case hardened, chrome plated, solid steel bodies resist cutting, sawing and corrosion
- Case hardened, plated, boron alloy steel shackleless protect against bolt cutters
- 5 and 6 Pin cylinders are pick-resistant
- Most models rekeyable



A700



A5100



A5200



A5300

### 700 SERIES

- AMA700D
- AMA700KA-32237
- AMA700KA-32274
- AMA700KA-43232
- AMA700KA-52544
- AMA701D
- AMA701KA-32275
- AMA701KA-43542
- AMA701KA-52544

- AMA5100D
- AMA5100KA-22337
- AMA5100KA-22353
- AMA5100KA-22845
- AMA5100KA-24278
- AMA5100KA-24554
- AMA5101KA-72532
- AMA5102KA-22572
- AMA5102KA-22755

### 5000 SERIES

- AMA5102KA-42232
- AMA5102KA-63427
- AMA5200COV
- AMA5200D
- AMA5200KA-22224
- AMA5200KA-22653
- AMA5200KA-24652
- AMA5200KA-24656
- AMA5200KACOV-43452
- AMA5201

- AMA5201KA-26842
- AMA5201KA-33768
- AMA5201KA-33842
- AMA5202COV
- AMA5202KA-25475
- AMA5202KA-42352
- AMA5202KA-44236
- AMA5260KA-43348
- AMA5300D

Model No.	Lock Body		Shackle		
	Wide	Thick	A	B	C
<b>5 PIN TUMBLER SECURITY 700 SERIES</b>					
<b>A700</b>	2 1/2"	1 1/8"	3/16"	1 1/16"	5/16"
<b>A701</b>	2 1/2"	1 1/8"	3/16"	2"	5/16"
<b>6 PIN TUMBLER SECURITY 2000 SERIES</b>					
<b>A2000</b>	2 3/16"	1 1/2"	-	-	-
<b>A2500</b>	2 3/16"	1 1/2"	-	-	-

5 PIN TUMBLER SECURITY 5000 SERIES					
<b>A5100</b>	1 1/2"	3/8"	1/4"	1"	3/8"
<b>A5101</b>	1 1/2"	3/8"	1/4"	1 1/2"	3/8"
<b>A5102</b>	1 1/2"	3/8"	1/4"	3"	3/8"
<b>A5200</b>	1 3/4"	3/4"	5/16"	1 1/2"	3/4"
<b>A5201</b>	1 3/4"	3/4"	5/16"	2"	3/4"
<b>A5202</b>	1 3/4"	3/4"	5/16"	3"	3/4"
<b>A5260</b>	2"	3/4"	3/8"	1 1/2"	3/4"

## SOLID BRASS PADLOCKS



AMA5560KA-42548

### Maximum Outdoor Security

**Features:**

- Solid brass bodies resist corrosion
- Ideal for harsh environments
- Case hardened boron alloy steel shackles resist cutting
- Rekeyable
- Solid brass body; case hardened, chrome plated, boron alloy steel shackle
- 1 3/8" (44mm) Wide ~ 3/4" (19mm) Thick, 5-PIN

Shackle		
A	B	C
3/16"	1 1/8"	3/4"

## PRO SERIES HIDDEN SHACKLE



**AMA2010W7000** Padlock Hidden Shackle  
2 3/4 in (73mm) Solid Steel Rekeyable 6-Pin Tumbler



**SOLID ALUMINUM PADLOCKS**

**General Indoor/Outdoor Security**

**Features:**

- Corrosion resistant solid aluminum
- Case hardened boron alloy steel shackles resist cutting
- Lightweight, spark resistant
- 1½" wide, ¼" thick

AMA1105BLK	Black
AMA1105CLR	Clear
AMA1105BLU	Blue
AMA1105BRN	Brown
AMA1105GRN	Green
AMA1105PRP	Purple
AMA1105RED	Red
AMA1105YLW	Yellow
AMA1106BLK	Black
AMA1106BLU	Blue
AMA1106GRN	Green
AMA1106ORJ	Orange

Model No.	Shackle		
	A	B	C
<b>A1105</b>	¼"	1"	¾"
<b>A1106</b>	¼"	1 ½"	¾"
<b>A1107</b>	¼"	3"	¾"

AMA1106RED	Red
AMA1105KABLK-32427	Black
AMA1105KABLU-32457	Black
AMA1105KABLU-27877	Blue
AMA1105KABLU-27886	Blue
AMA1105KABRN-32247	Brown
AMA1105KAGRN-32338	Green
AMA1105KAGRN-32367	Green
AMA1105KARED-32384	Red
AMA1105KAYLW-32278	Yellow
AMA1105KAYLW-32375	Yellow
AMA1107KABRN-02552	Brown



**COMBINATION PADLOCKS**



**General Security**

**Features:**

- 3-Number Dial
- Automatic scrambler feature (automatically moves the dial upon closing the shackle for extra security)
- Stainless Steel, 2" Body

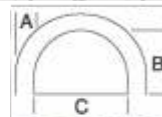

AMA400KBLK-559 Comb/Key Control  
AMA400KEY-559 400K Control Key

Model No.	Shackle		
	A	B	C
<b>AMA400KBLK-559</b>	½"	¾"	¾"

**MULTI-CYLINDER PADLOCKS**

**Multi-Cylinder Series 3600 and 3700 Accepts:**

- Medeco #20-0101 6-pin cylinder for Schlage "A" series knob set
- Schlage "A" series (key-in knob) cylinder
- Lori/Ilco #1539 6-pin cylinder for Schlage key-in knob keyways. Ilco 15995

**Features:**

- Integrates with door hardware cylinders
- Accepts Medeco, Schlage and Lori/Ilco cylinders
- Only a Phillips Screwdriver is needed to complete cylinder placement
- Double steel ball locking mechanism that makes shimming virtually impossible
- Solid brass body; case hardened, chrome plated, boron alloy steel shackle

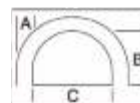

Model No.	Shackle		
	A	B	C
<b>A3600WO</b>	¾"	1 ½"	¾"
<b>A3601WO</b>	¾"	2"	¾"
<b>A3602WO</b>	¾"	3"	¾"
<b>A3700WO</b>	¾"	1 ½"	¾"

☐ Drivers and cylinders not included.



A3600WO

A3700WO



3650

3651

3652

**AMA3650WO** Padlock Multi-Cylinder Brass  
**AMA3651WO** Padlock Multi-Cylinder Brass 2" Shackle  
**AMA3652WO** Padlock Multi-Cylinder Brass 3" Shackle



## EDGE PARTS

**AMAPKG0049969** Rim Tailpiece Fixed  
10 Per Package

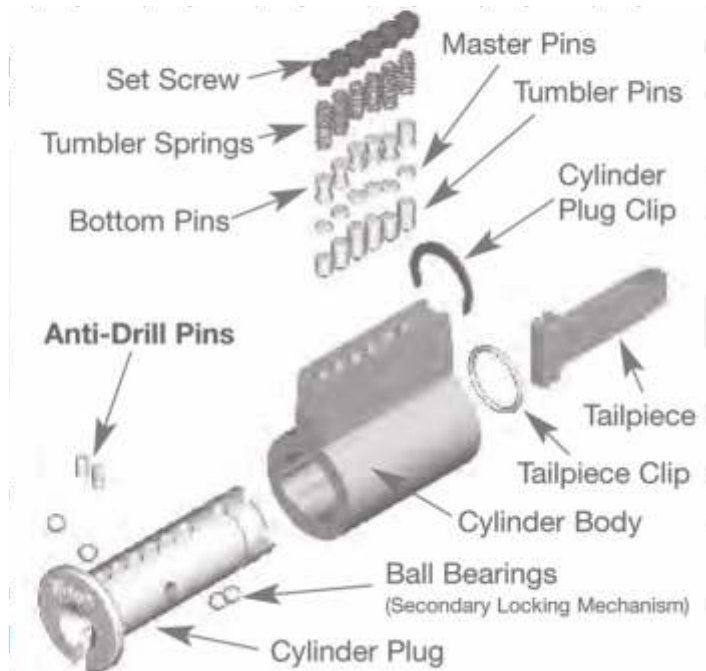

## HEAVY DUTY HASPS



**AMA850D**  
Display Carded



**AMA875**  
Boxed



**AMA885D**  
Display Carded



**AMA825**  
Boxed



**AMA810**



**AMA800LHCD**



**AMA801**

**Features/Recess:**

- Recessed concealed screws
- All mounting hardware included

Model No.	Description	Length	Width
<b>A800LHCD</b>	Hidden Shackle	8 3/4"	1 1/2" 1/2"
<b>A825</b>	Straight Bar,		
	1/8"	7 1/4"	1 3/8"
<b>A850D</b>	90 Degree Angle Bar	4 1/4"	1 3/8"
<b>A875</b>	Single Hinge	6 1/4"	1 3/8"
<b>A885D</b>	Double Hinge	7 3/4"	1 3/8"

□ Hasp Models 535 and 825 can be used with Lock Models 2000 and 2010  
A825 Fits 1 1/2" and 2" gate frames with 3-6" openings

### Slide Locking Bolt

**Features:**

- 3/8" solid hardened steel throw
- Chrome plated for corrosion resistance
- Fully adjustable from 3/4" to 2 3/8" (19mm - 60mm)



**AMA895**

## PARTS

### APTC12

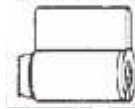

#### COVER PLATE SPECIAL

AMAPKG4680230 A700

- **APTC-12** - 5-pin cylinder for Series 700, 1000 and 5000.
- **APTC-12WP** - 6-pin cylinder for Edge FB Padlock

#### SPRINGS & BOTTOM PINS - Pkg of 100

AMAPKG3054010	Tumbler Spring
AMAPKG3682010	Bottom Pin #1
AMAPKG3682020	Bottom Pin #2
AMAPKG3682030	Bottom Pin #3
AMAPKG3682090	Bottom Pin #4
AMAPKG3682050	Bottom Pin #5
AMAPKG3682060	Bottom Pin #6
AMAPKG3682070	Bottom Pin #7
AMAPKG3682080	Bottom Pin #8

#### REPLACEMENT CYLINDERS

AMAPTC12-KA-45672  
 AMAPTC12  
 AMAPTC12WP6UN-FB

## PIN KITS

### PIN TUMBLER SERVICE KIT



AMASK8

For Servicing American Series 700, 1000 and 5000 Padlocks. Kit includes: 100 ea. Bottom pins 1-8, 100 ea. master pins 2-7, (100) top pins, (100) driver springs, (12) small A5000 series ball bearings, (12) large A700 series ball bearings, (25) security screws, (25) security nuts, (2) A700 series trap doors, (4) A5000 series trap doors, 1) American Lock 6-pin, APTC14 cylinder, (2) A700 series actuators, (4) A5000 series actuators, (1) American Lock 5-pin, APTC12 cylinder, (10) snap rings & (1) follower tool.

## KEY BLANKS



K5BOX



KBBOX



KWP4BOX



KWP6BOX

**AMAK5BOX**  
**AMAK6BOX**  
**AMAKBBOX**  
**AMAKW748**  
**AMAKWP4BOX**  
**AMAKWP6BOX**

Key Blank 5-Pin Standard  
 Key Blank 6-Pin Standard  
 Key Blank Blade Standard  
 Key Blank A748 6-Pin  
 Edge EL Key Blank 4-Pin  
 Edge EL Key Blank 6-Pin

## ELECTRONIC SAFE LOCKS



### ESL10

AMSEC has been a pioneer in the electronic lock market. The ESL series locks offer unrivaled value in electronic safe access. The ESL10XL and ESL20XL locks have the best blend of features and function in Electronic Safe Locks. The ESL10XL is a basic keypad lock for home and office applications. The ESL20XL offers advanced features necessary for commercial applications.

*ESL10XL Features:*

- 1 User Combination
- Factory Reset Code
- (2) 9V Battery in Keypad
- 15 Minute Penalty Lockout
- Auxiliary Battery Pack Option



### ESL20XL

*Additional Features:*

- Time Delay Mode, 1-99 Minute
- Multi-User Mode, 8 User Combinations
- Armored Car Time Delay Bypass Mode
- Dual Control Mode
- External Control Mode
- A/C Power Option
- Duress Mode Option (w/Exp. Mod.)

- ASESL10XL-BLACK
- ASESL10XL-BRASS
- ASESL10XL-CHROME
- ASEXL20XL
- ASESL15
- ASESL5-BLACK
- ASESL5-CHROME

- Matte Black
- IN BLACK
- ILLUMINATED
- ILLUMINATED

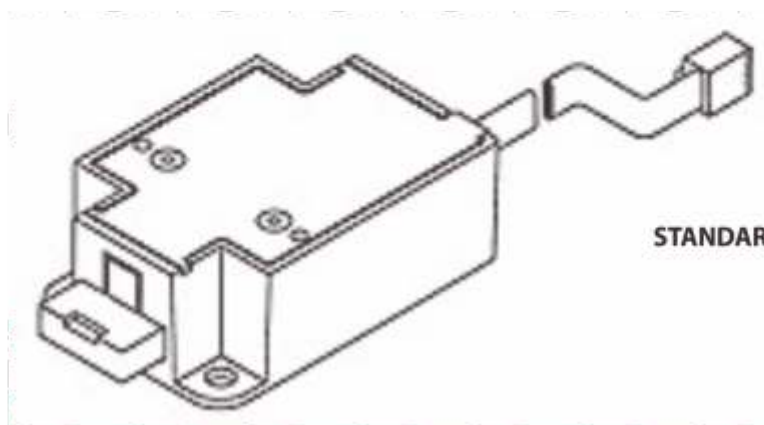

STANDARD BOLT



# Arrow's heavy duty Professional Replacement Products.

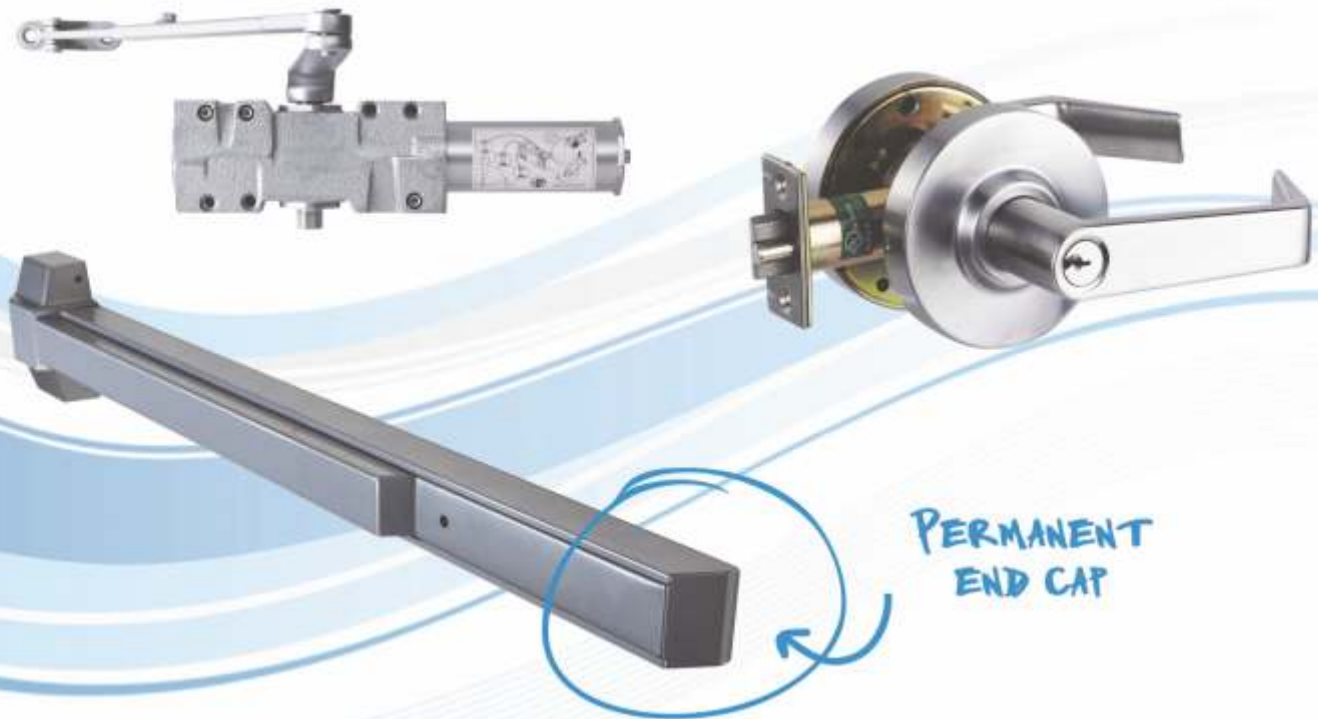

For more information, visit  
[www.arrowlock.com](http://www.arrowlock.com).

Competitively priced and easy to install, the MLX Lever, DC500 Closer and PEC910 Permanent End Cap Exit Device are efficient and economical options that deliver fast retrofitting and robust security features.

ASSA ABLOY, the global leader  
in door opening solutions

**ARROW**<sup>™</sup>  
LOCK & DOOR HARDWARE  
**ASSA ABLOY**

**7900 SERIES**

**POWERED DOOR OPERATOR**

*The Arrow 7900 Series powered door operators are low-energy operators which function as standard spring-force closers during close cycles when a door is opened manually, or if power is lost or turned off.*

AW7936HRP-AL  
 AW7936HRP-DBZ  
 AW7936SRP-AL  
 AW7936SRP-DBZ

ALUMINUM FINISH  
 DARK BRONZE FINISH  
 ALUMINUM FINISH  
 DARK BRONZE FINISH

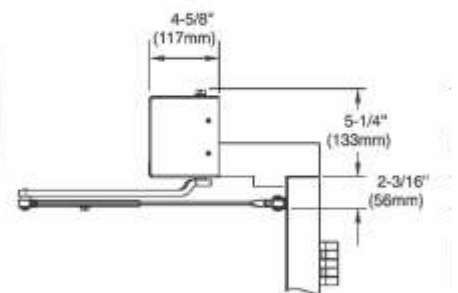
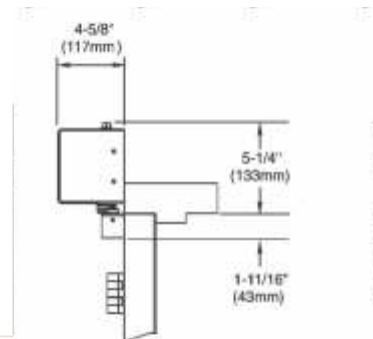

**RADIO FREQUENCY (RF1) KIT**

- Radio Frequency Receiver (433 MHz)
- Activation switches not included

AW7710RK RADIO FREQUENCY (RF1) KIT



**DC500 SERIES**

**DC516**

- BHMA certified grade 1
- 10 year warranty
- Heavy duty cast iron body
- Hardened steel rack and pinion
- Full plastic cover standard
- Non-handed for regular, top jamb and parallel arm mount applications
- Supplied with self-tapping screws, sleeve nuts and thru-bolts
- DC516-2 has a heavy duty parallel arm with a stop feature for door openings between 90° and 110°
- DC516-3 has a heavy duty parallel arm with a stop and thumb turn hold open feature for door openings between 90° and 110°



AWDC516-AL	NHO Arm w/PA	AWDC516-2-AL	HD Dead Stop NHO
AWDC516-DBZ	NHO Arm w/PA	AWDC516-2-DBZ	HD Dead Stop NHO
AWDC516-1-AL	HO Arm w/PA	AWDC516-3-AL	HD Dead Stop HO
AWDC516-1-DBZ	HO Arm w/PA	AWDC516-3-DBZ	HD Dead Stop HO

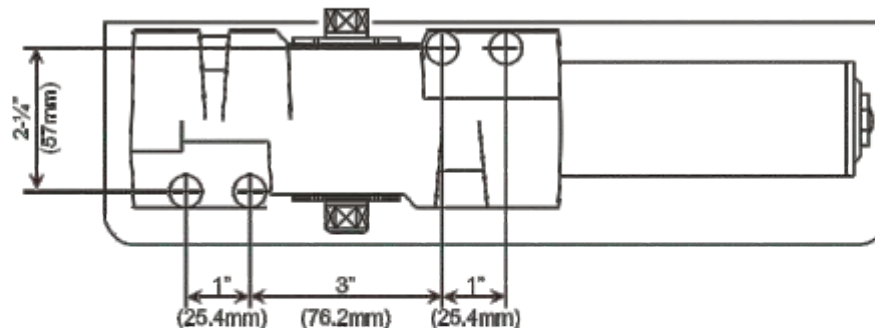

**DROP PLATES**



*Regular*  
AWDC500DP-AL  
AWDC500DP-DBZ

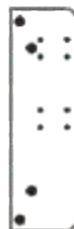

*Parallel*  
AWDC500DP1-A1  
AWDC500DP1-DBZ

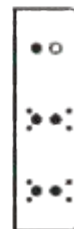

*Top Jamb*  
AWDC500DP2-AL  
AWDC500DP2-DBZ

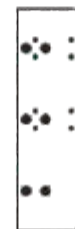

*Top Jamb Flush*  
AWDC500DP3-AL  
AWDC500DP3-DBZ

**DB SERIES**

**GRADE 2 DEADBOLT**

AWDB61-605-CS-KA4  
AWDB61-630-CS-KA4  
AWDBX62-605-CS-KA4  
AWDBX62-630-CS-KA4

SCHLAGE C KEYWAY  
SCHLAGE C KEYWAY  
GRADE 2 DOUBLE DEADBOLT  
GRADE 2 DOUBLE DEADBOLT





**QL SERIES**

**GRADE 1 LEVER**

- Free – Wheeling Lever
- 10yr warranty
- 2 screw install
- UL 3 Hour Listed

AWQL01-SB-26D	Passage
AWQL01-SB-10BP	Privacy
AWQ71-32D	Deadlatch 2 3/4"
AWQ73-32D	Springlatch 2 3/4"
AWQL72-SB-26D	Privacy
AWQL72-SB-10BP	Privacy
AWQL81-SB-10BP-CS-KD	Entrance
AWQL81-SB-26D-CS-KD	Entrance
AWQL81-SB-26D-IC	Entrance
AWQL81-SB-26D-LIC	Entrance
AWQL81-SB-26D-SIC	Entrance
AWQL81-SB-10BP-CS-KD	Entrance
AWQL81-SB-26D-IC	Entrance
AWQL82-SB-26D-IC	Storeroom
AWQL82-SB-10BP-CS-KD	Storeroom
AWQL82-SB-26D-CS-KD	Storeroom
AWQL82-SB-26D-LIC	Storeroom



AWQL82-SB-26D-SIC	Storeroom
AWQL87-SB-26D-IC	Classroom
AWQL87-SB-10BP-CS-KD	Classroom
AWQL87-SB-26D-CS-KD	Classroom
AWQL87-SB-26D-LIC	Classroom
AWQL87-SB-26D-SIC	Classroom
AWQL97-SB-10BP-CS-KD	Class Intruder
AWQL97-SB-26D-CS-KD	Class Intruder
AWQL97-SB-26D-IC	Class Intruder
AWX-QL97-03A-26D	Key Rotation Indicator Rose

**MLX SERIES**

**GRADE 2 LEVER**

- Free – Wheeling Lever
- 10yr warranty
- 2 screw install

AWMLX01-SB-26D	Passage
AWMLX01-SB-10BP	Passage
AWMLX72-SB-26D	Privacy
AWMLX72-SB-10BP	Privacy
AWMLX81-SB-03-CS-KD	Entrance
AWMLX81-SB-10BP-CS-KD	Entrance
AWMLX81-SB-26D-CS-KD	Entrance
AWMLX81-SB-26D-IC	Entrance
AWMLX81-SB-26D-SIC	Entrance
AWMLX81-SB-10BP-CS-KD	Storeroom
AWMLX82-SB-03-CS-KD	Storeroom
AWMLX82-SB-10BP-CS-KD	Storeroom
AWMLX82-SB-26D-CS-KD	Storeroom
AWMLX82-SB-26D-IC	Storeroom



AWMLX82-SB-26D-SIC	Storeroom
AWMLX87-SB-10BP-CS-KD	Classroom
AWMLX87-SB-26D-CS-KD	Classroom
AWMLX87-SB-26D-IC	Classroom
AWMLX87-SB-26D-SIC	Classroom
AWMLX87-SB-03-CS-KD	Classroom

**GL SERIES**

AWGL81-SR-26D-LIC	ENTRY LEVER MED/ASSA	G1
AWGL82-SR-26D-LIC	STORE LEVER MED/ASSA	G1
AWGL87-SR-26D-LIC	CLASS LEVER MED/ASSA	G1

**GL SERIES PARTS**

AWR20-32D	Deadlatch 2 3/4"
AWR21-32D	Deadlatch 2 3/4"
AWR22-32D	Springlatch 2 3/4"
AWR23-32D	Springlatch 2 3/4"



**ED910 SERIES**

**EXIT DEVICES**

AWED910-36-32D  
AWED910-36-AL  
AWED910-36-BRZ  
AWED910-48-32D  
AWED910-48-AL  
AWED910-48-BRZ

SATIN STAINLESS STEEL  
ALUMINUM (SPRAYED FINISH)  
DARK BRONZE (SPRAYED FINISH)  
SATIN STAINLESS STEEL  
ALUMINUM (SPRAYED FINISH)  
DARK BRONZE (SPRAYED FINISH)



**PERMANENT END CAP EXIT DEVICE**

AWPEC910-36-32D  
AWPEC910-36-AL  
AWPEC910-36-BRZ

SATIN STAINLESS STEEL  
ALUMINUM (SPRAYED FINISH)  
DARK BRONZE (SPRAYED FINISH)

**INSTALLATION TEMPLATE**

AWES9TMPLT-36-FIN

FOR PEC910 EXIT DEVICES



**BLANK PLATE TRIM**

AWSF01-AL  
AWSF01-BRZ

ALUMINUM (SPRAYED FINISH)  
DARK BRONZE (SPRAYED FINISH)



**DUMMY PULL PLATE TRIM**

AWSF02-AL  
AWSF02-BRZ

ALUMINUM (SPRAYED FINISH)  
DARK BRONZE (SPRAYED FINISH)



**STOREROOM PLATE TRIM**

AWSF12-CS-KD-AL  
AWSF12-CS-KD-BRZ

ALUMINUM (SPRAYED FINISH)  
DARK BRONZE (SPRAYED FINISH)



**STOREROOM/CLASSROOM LEVER PLATE TRIM**

AWSRX82-IC-26D  
AWSRX82-CS-KD-10B  
AWSRX82-CS-KD-26D  
AWSRX87-CS-KD-10B  
AWSRX87-CS-KD-26D  
AWSRX87-IC-26D

ED900 STOREROOM LEVER TRIM  
(Storeroom) DARK OIL-RUBBED BRONZE  
(Storeroom) SATIN CHROME  
(Classroom) DARK OIL-RUBBED BRONZE  
(Classroom) SATIN CHROME  
ED900 CLASSROOM LEVER TRIM



**MORTISE CYLINDERS**

**Twin 6000, Twin Exclusive, V-10, Max+ and Max+ Restricted**

**Features:**

- Drill resistant cylinder housing and plug
- Case-hardened steel inserts and stainless steel pins
- Two independent locking mechanisms to ensure optimum pick resistance
- Inactive "false" grooves on side pins designed to catch picking tools
- Extremely close tolerances
- Can be easily rekeyed in the field
- With the purchase of one inexpensive kit, 1 1/2" mortise cylinder is easily converted to rim cylinder
- ASSA guarantees its cylinders against defective workmanship or wear resulting from defects for life



**Twin 6000**

- 1 1/2" A/R CAM
- AI6651-1-624-SNS
- AI6551-1-626-SNS

**Twin Exclusive**

- 1 1/2" A/R CAM
- AI6651-1-624-SNS
- AI6651-1-626-SNS

**Twin V-10**

- 1 1/2" A/R CAM
- AI6651-1-624-SNS
- AI6651-1-626-SNS
- 1 1/2" Yale CAM
- AI6651-5-626-SNS
- 1 1/4" Yale CAM
- AI6652-5-624-SNS

**Max+**

- 1 1/2" A/R CAM
- AI9851-1-624-SNS
- AI9851-1-626-SNS

**Max+ Restricted**

- 1 1/2" A/R CAM
- AIR2851-1-624-SUB
- AIR2851-1-626-SUB

**MORTISE CYLINDER PARTS**

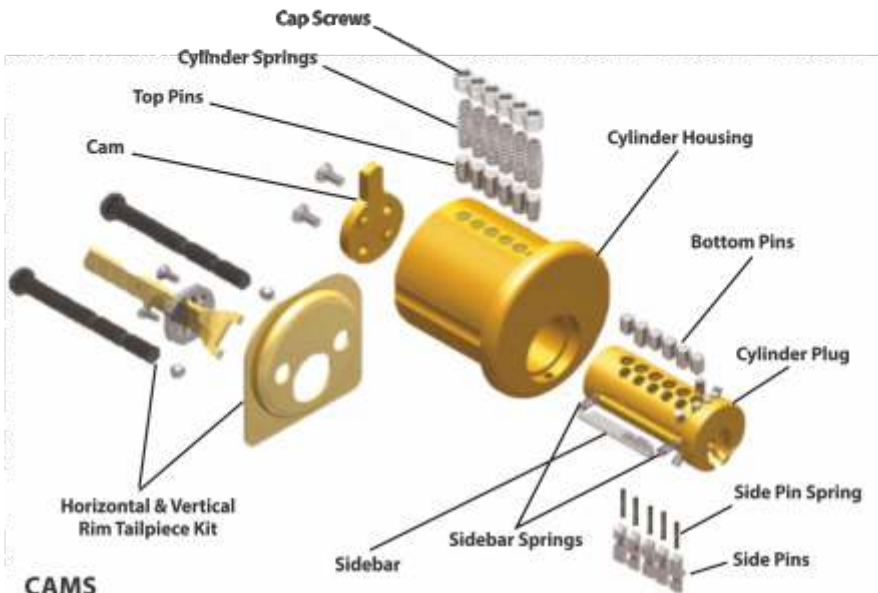

**SIDEBARS**

- AI267008-

**SIDE PINS**

- AI353838 V-10 Side Pin (Pkg/50)
- AI867015 Twin Side Pins (Pkg/50)

**SPRINGS**

- AI807164 V-10 Sidebar Spring (Pkg/100)
- AI807165 V-10 Sidepin Spring (Pkg/100)
- AI867065 Cylinder Springs (Pkg/100)
- AI867088 Twin Sidebar Spring (Pkg/100)
- AI867087 Twin Sidepin Springs (Pkg/100)

**RIM TAILPIECE KITS**

- AI867450 Horizontal & Vertical
- AI867451 Lazy-Motion

**CAMS**

- AI867445 #1 Adams Rite
- AI867452 #2 Sargent
- AI867446 #3 Corbin Clover Leaf
- AI867447 #4 Corbin Beaver Tail
- AI872610 #5 Yale/Standard
- AI867453 #6 Schlage "L"
- AI805412 #7 Segal Type
- AI806471 #8 Jumbo Corbin
- AI907306 #9 Best 30H Series
- AI353445 #10 Airtec/Norment
- AI809337 #11 Airtec/Norment Mogul
- AI354945 #12 Corbin Jumbo Clover Leaf
- AI355849 #13 Sargent Short
- AI355850 #14 Sargent Mogul
- AI872612 #15 Yale Replacement Cam

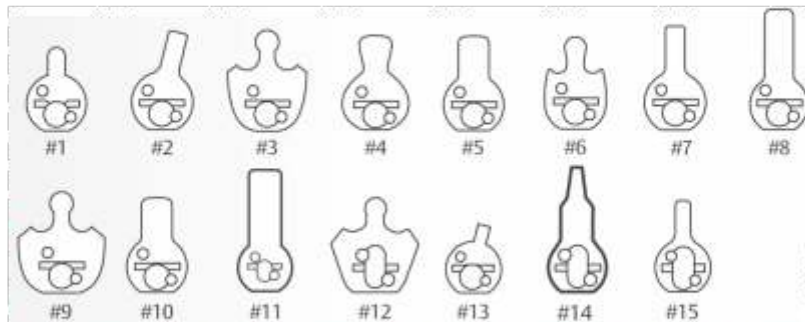



**RIM CYLINDERS**

**RIM CYLINDERS — 1 1/8" W/HORIZONTAL TAILPIECE**

**Features:**

- Drill resistant cylinder housing and plug
- Case-hardened steel inserts and stainless steel pins
- Two independent locking mechanisms to ensure security and optimum pick resistance
- Inactive "false" grooves on side pins designed to catch picking tools
- Extremely close tolerances
- Standard rim cylinder is easily converted to mortise cylinder



**Twin 6000**

AI6551-H-624-SNS  
AI6551-H-626-SNS

AI867109 Break-o! Tailpiece

**Twin Exclusive**

AIE6551-H-624-SNS  
AIE6551-H-626-SNS

**V10**

AIV6551-H-624-SNS  
AIV6551-H-626-SNS

**Max+**

AI9851-H-624-SNS  
AI9851-H-626-SNS

**Max+ Restricted**

ASR2951-H-624-SUB  
ASR2951-H-626-SUB

**KEY-IN-KNOB / LEVER CYLINDER**

**Features:**

- Two independent locking mechanisms to ensure security and optimum pick resistance
- Inactive "false" grooves on side pins designed to catch picking tools
- Extremely close tolerances

**Schlage Standard and heavy-duty 6-pin**

(Includes: Cap, Pin, Spring, & Tailpiece)

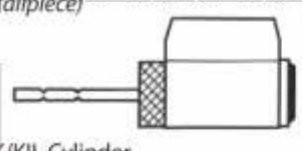

**Twin 6000**

AI65611-606-SNS	SCH KIK/KIL Cylinder
AI65611-626-SNS	SCH KIK/KIL Cylinder
AI-65652-626-SNS	COR/RUS KIK Cylinder
AI65672-626-SNS	SARGENT KIK Cylinder
AI65673-626-SNS	SARGENT KIL Cylinder
AI65632-626-SNS	YALE KIL Cylinder

**Twin Exclusive**

AIE65611-626-SNS	SCH KIK/KIL Cylinder
AIE65611-606-SNS	SCH KIK/KIL Cylinder

**V10**

AIV65611-626-SNS	SCH KIK/KIL Cylinder
AIV65611-606-SNS	SCH KIK/KIL Cylinder



**Max+**

AI98611-606-SNS	SCH KIK/KIL Cylinder
AI98611-626-SNS	SCH KIK/KIL Cylinder

**Max+ Restricted**

AIR28611-606-SUB	SCH KIK/KIL Cylinder
AIR28611-626-SUB	SCH KIK/KIL Cylinder

AI804877

Break-o! Tailpiece

AI868958

SCH KIK Plug Cap

**IC CORE**

**Twin 6000**

AI70600IC-626-SNS

**Twin Exclusive**

AIE70600IC-626-SNS

**V10**

AIV70600IC-626-SNS

**Max+**

AI98600IC-626-SNS

**Housing**

AI60601-5-626 IC Core Mort

**KEY BLANKS**

AI867091

TWIN Exclusive Key Blank

AI250694

V-10 Key Blank

AI323330

MAX + Key Blank

**DEADBOLTS**

**Features:**

- ASSA Hardhat™ free spinning guard collars to prevent wrenching
- ¼" Aircraft strength steel mounting bolts
- Hardened bolt with full 1" throw



M80 grd 2 dbolt



**Twin 6000**

- AI7000-626-SNS SNG 2 ¾" BS GRD 1
- AI7000DC-626-SNS DBL 2 ¾" BS GRD 1

**Twin Exclusive**

- AIE7900-626-SNS SNG 2 ¾" BS GRD 1
- AIE7900DC-626-SNS DBL 2 ¾" BS GRD 1
- AIEM80-626-SNS SNG F ADJ BS GRD 2

**V10**

- AIE7900-626-SNS SNG 2 ¾" BS GRD 1
- AIE7900DC-626-SNS DBL 2 ¾" BS GRD 1
- AIEM80-626-SNS SNG F ADJ BS GRD 2

**Max+**

- AIE7900-626-SNS SNG 2 ¾" BS GRD 1
- AIE7900DC-626-SNS DBL 2 ¾" BS GRD 1
- AIEM80-626-SNS SNG F ADJ BS GRD 2

**PADLOCKS**

**Features:**

- Chrome plated extruded brass with a rust resistant case hardened steel shackle
- Locking mechanism utilizes two case hardened steel balls and there are no external rivets or screws
- Weep holes for positive water drainage



**Twin 6000**

- AI65190B-SNS #2 NKR 1" Shackle
- AI65190LB-SNS #2 NKR 1" Shackle
- AI65191B-SNS #2 KR 1" Shackle
- AI65191LB-SNS #2 KR 2" Shackle

**Twin Exclusive**

- AIE65190B-SNS #2 NKR 1" Shackle
- AIE65190LB-SNS #2 NKR 2" Shackle
- AIE65191B-SNS #2 KR 1" Shackle
- AIE65191LB-SNS #2 KR 2" Shackle

**V10**

- AIV65191LB-SNS #2 NKR 2" Shackle
- AIV65190B-SNS #2 NKR 1" Shackle
- AIV65190LB-SNS #2 NKR 2" Shackle
- AIV65191B-SNS #2 KR 1" Shackle

**Max+**

- AI98190B-SNS #2 NKR 1" Shackle
- AI98190LB-SNS #2 NKR 2" Shackle
- AI98191B-SNS #2 KR 1" Shackle
- AI98191LB-SNS #2 KR 2" Shackle



**Combination Resettable Brass Padlock**

- AISR36D 4-Dial 1" Shackle
- AISR37D 4-Dial 2 ¼" Shackle

**PIN KITS & ACCESSORIES**

**AI PK-1**



**TWIN V-10, TWIN EXCLUSIVE, TWIN 6000 and MAX+ Full Size Pin Kit**

MASTER PINS	BOTTOM PINS	DRIVER PINS
AI867070 1	AI867078 1	AI807261 1-2
AI867071 2	AI867079 2	AI807262 3-4
AI867072 3	AI867080 3	AI807263 5-6
AI867073 4	AI867081 4	AI807264 7-9
AI867074 5	AI867082 5	-----
AI867075 6	AI867083 6	-----
AI867076 7	AI867084 7	-----
AI867077 8	AI867085 8	-----
-----	AI867086 9	-----

AI868141 Pin Chamber Closing Strips



Key Gauge AIKD-98

**CLIQ**

**Lock Spray Lubricant**  
AI807718

**Lock Cleaner / Deicer**  
AI816296

**Key Cover**  
AI359117 Plastic ASSA Side  
AI359120 Plastic CLIQ Side  
AI359297 Metal PACE (Old)  
AI359438 Screw (Old)



**AUTO REFERENCES**

**AUTOTEL**

**AUTOTEL** is a computer program designed to take vehicle information from all the major locksmith lock manufacturers (All Lock (BWD), Auto-Security Products, Strattec), key blank usage, and pricing, and puts them together in one simple to use program.

APAUTOTEL-CD Software CD  
 APAUTOTEL-UP-15 Update 2015

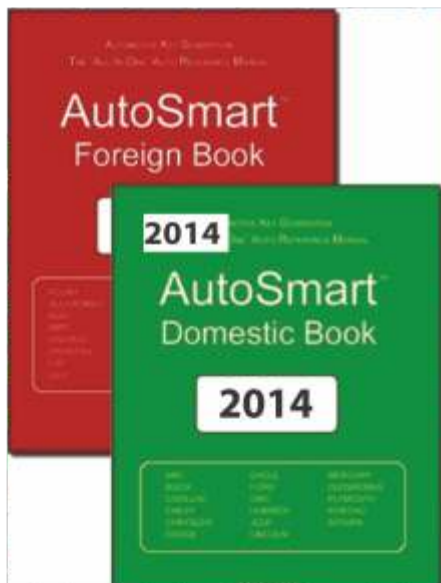
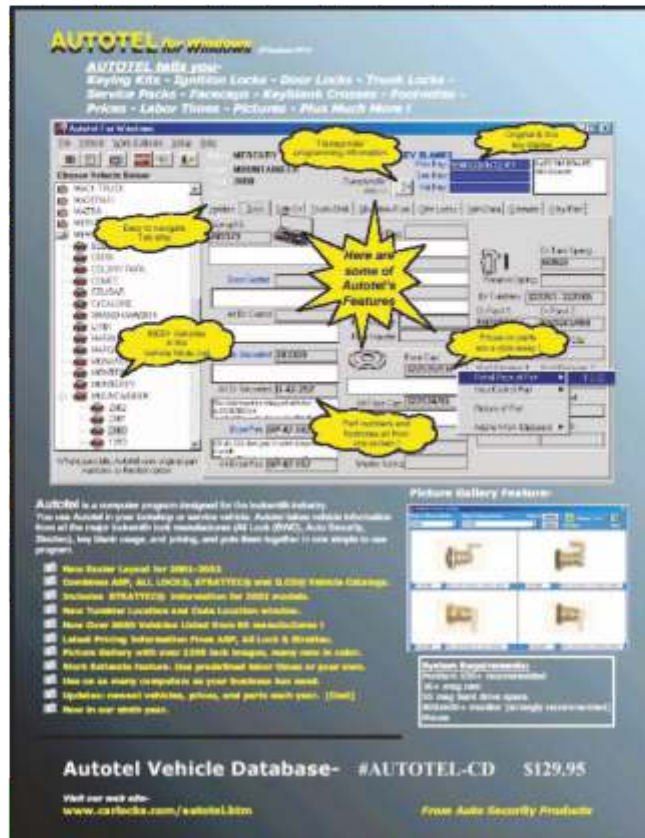

**AUTOSMART 2014 BOOK SET**

Expanded Keyblank Application Guide - with the latest transponder key application information.

APAS2014SET AutoSmart 2014

**TRANSPONDER BOOK**

By HYDA

APT82013

**KEYING & FACE CAP KITS**

- APA-16-108 Nissan Pathfinder
- APA-19-108 Honda (A-19-106 + A-19-107) 4 Track
- APA-42-111 Ford 10-Cut Ignition Sidebar

**KEYS**



- APKB-57-101 Kenworth Peterbilt Pkg of 5

**VATS**

- APUG-301 Vats Sgl Sided Adapter, Pkg of 5
- APUG-302 Vats Dbl Sided Adapter, Pkg of 5
- APUG-402 Vats Probe Interrogator





**IGNITION LOCKS**

	APC-19-113 CIVIC 92-95 APC-19-119 ACCORD 2005		APC-30-129 CAMRY 92-96 APC-30-130 COROLLA Japan 93-96 APC-30-131 COROLLA USA 93-96 APC-30-140 TACOMA APC-30-142 AVALON APC-30-152 COROLLA 98-02
<p><b>10 CUT (Small ears)</b></p>		<p><b>10 CUT (Big Ears)</b></p>	
	APC-42-117 Uncoded, Chrome APC-42-127 Uncoded, Black	APC-42-140 Black APC-42-142 #2, Black APC-42-143 #3, Black APC-42-147 Uncoded, Black APC-42-150 Chrome APC-42-152 #2, Chrome APC-42-157 Uncoded BG, Chrome APC-42-167 Uncoded Contour, Chrome APC-42-187 Focus USA, Chrome APC-42-194 Uncoded Escort 91-96, Chrome APC-42-406 Chrome APC-42-407 Chrome	
<p><b>10 CUT (Dome)</b></p>			
APC-42-137 Uncoded			
<p><b>8 CUT (Big Ears)</b></p>			
APLC6177 HUFTYPE Crown Vic, Chrome APLC6177U Uncoded, Chrome			

**DOOR LOCKS**

	APD-16-206 Nissan (X123)		APD-42-208 10- Cut Round Black EXPL/Ranger
---	--------------------------	---	--

**SERVICE PARTS**

	<p><b>TUMBLER X172 (25/pkg)</b></p>		<p><b>WAFER (25/pkg)</b></p>
APP-19-141 #1 APP-19-142 #2 APP-19-143 #3 APP-19-144 #4 APP-19-145 #5		APP-30-181 #1 Full APP-30-182 #2 Full APP-30-183 #3 Full APP-30-184 #4 Full APP-30-185 #1 Split	
<p><b>CAPS (10/pkg)</b></p>			<p><b>TUMBLER 10 CUT — Sidebar (25/pkg)</b></p>
APP-16-205 Face Cap-Datsun/Nissan 1982-UP APP-16-213 Door Cap-96 Pathfinder APP-40-201 Face Cap-Aspire & Hyundai Dr/Trk APP-42-201 Face Cap-Ford 84 1/2-Up Chrome APP-42-202 Face Cap-Ford 84 1/2-Up Black APP-42-265 Face Cap- Ford APP-42-266 Face Cap- Ford		APP-42-191 #1 APP-42-192 #2 APP-42-193 #3 APP-42-194 #4 APP-42-195 #5	
		APP-42-190 APP-42-288 APP-42-308 APP-30-108	Springs Tumbler 10-Cut Ignition (50/PKG) Ford Spring Cover Seal Plate (25/PKG) 10-Cut Dr Pawl RH-LH New Spring-Toyota (50/PKG)



**Multi-Purpose Oil**

BA120069 6OZ Aerosol Can

**HANDLES**
**LOCKING 'L' HANDLES**
**L-201**

- Bright Chrome
- Cross Section-5/16" square length: 3-5/8"
- Rotation: 360°

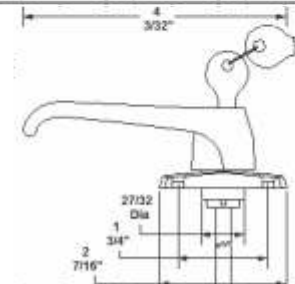
BPL201C-EXT1.75"-CH751

**L-204R**

- Bright Chrome
- Insert: Cross Section-5/16" square length: 3-5/8"
- Rotation: 360°

BPL204R-1-1/2-KA-CH751

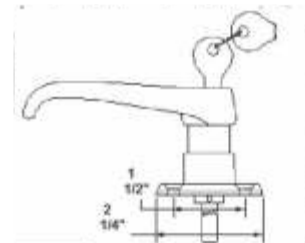
**LOCKING 'T' HANDLES**
**T-303**

- Bright Chrome and Black
- Cross Section - 5/16" square
- Rotation Options: 90CW and 360°

BPT303C-EXT1.5"-CH751

BPT303C-EXT1.5"-KD

BPT303C-EXT1.75"-KD

BPT303B-2-DC-90KACH751

BPT303B-EXT1.5"-KD

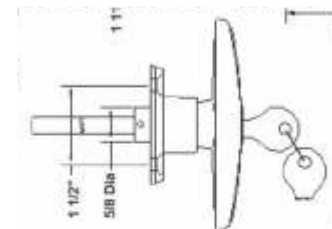
**T-307**

BPT307C-B1.5"-CH751

BPT307C-B1.5"-KD

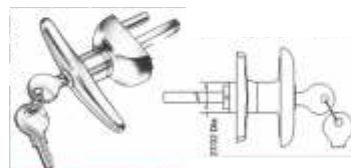
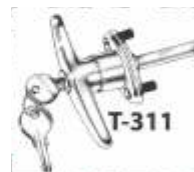
**CAMPER TOP HANDLES**

BPT311B-B1.5"-CH751

BPT311B-B1.5"-KD

BPT311B-B1.5"-K127

**KEY BLANKS**

BPAE

Key Blank Dbl Sided

BPCP

Key Blank Sgl Sided

BPML, CH, J, DM

Key Blank Dbl Sided

BPRV3000

Key Blank Series 301-370

**CORES**

**6-PIN CORES**



- BE1C6A1-626
- BE1C6D1-626
- BE1C6E1-626
- BE1C6F1-626
- BE1C6G1-626
- BE1C6H1-626
- BE1C6J1-626
- BE1C6K1-626
- BE1C6L1-626
- BE1C6M1-626
- BE1CP6WG1-626
- BE1CP7WG1-626

- A KEYWAY
- D KEYWAY
- E KEYWAY
- F KEYWAY
- G KEYWAY
- H KEYWAY
- J KEYWAY
- K KEYWAY
- L KEYWAY
- M KEYWAY
- WC KEYWAY
- WH KEYWAY

**7-PIN CORES**



- BE1C7A1-626
- BE1C7BA1-626
- BE1C7D1-626
- BE1C7E1-626
- BE1C7F1-626

- A KEYWAY
- BA KEYWAY
- D KEYWAY
- E KEYWAY
- F KEYWAY

**7-PIN CORES (CONTINUED)**

- BE1C7G1-626
- BE1C7H1-626
- BE1C7J1-626
- BE1C7K1-612
- BE1C7K1-626
- BE1C7L1-626
- BE1C7M1-626
- BE1C7Q1-626
- BE1C7R1-626
- BE1C7TB1-626
- BE1C7TD1-626
- BE1C7TE1-626
- BE1CP7WA1-626
- BE1CP7WC1-626
- BE1CP7WG1-626
- BE1CP7WH1-626
- BE1C7TA1-626
- BE1C7TC1-626

- G KEYWAY
- H KEYWAY
- J KEYWAY
- K KEYWAY
- K KEYWAY
- L KEYWAY
- M KEYWAY
- Q KEYWAY
- R KEYWAY
- TB KEYWAY
- TD KEYWAY
- TE KEYWAY
- WA KEYWAY
- WC KEYWAY
- WG KEYWAY
- WH KEYWAY
- TA KEYWAY
- TC KEYWAY

**KEY BLANKS**

**KEY BLANKS (A-J)**

- BE1A1A1 A KEYWAY
- BE1A1B1 B KEYWAY
- BE1A1BA1KS208KS800 BA KEYWAY
- BE1A1C1 C KEYWAY
- BE1A1D1 D KEYWAY
- BE1A1E1 E KEYWAY
- BE1A1E1KS208KS800 E KEYWAY
- BE1A1F1 F KEYWAY
- BE1A1F1KS208KS800 F KEYWAY
- BE1A1G1 G KEYWAY
- BE1A1G1KS208KS800 G KEYWAY
- BE1A1H1 H KEYWAY
- BE1A1H1KS208KS800 H KEYWAY
- BE1A1J1 J KEYWAY
- BE1A1J1KS208KS800 J KEYWAY



**KEY BLANKS (K-TE)**

- BE1A1K1 K KEYWAY
- BE1A1K1KS208KS800 K KEYWAY
- BE1A1L1 L KEYWAY
- BE1A1L1KS208KS800 L KEYWAY
- BE1A1M1 M KEYWAY
- BE1A1M1KS208KS800 M KEYWAY
- BE1A1Q1 Q KEYWAY
- BE1A1Q1KS208KS800 Q KEYWAY
- BE1A1R1 R KEYWAY
- BE1A1R1KS208KS800 R KEYWAY
- BE1A1TA1KS208KS800 TA KEYWAY
- BE1A1TB1 TB KEYWAY
- BE1A1TD1 TD KEYWAY
- BE1A1TD1KS208KS800 TD KEYWAY
- BE1A1TE1 TE KEYWAY
- BE1A1TE1KS208KS800 TE KEYWAY

**PREMIUM KEY BLANKS**

- BE1AP1WA1 WA KEYWAY
- BE1AP1WB1 WB KEYWAY
- BE1AP1WC1 WC KEYWAY
- BE1AP1WG1 WG KEYWAY





## PINS

**A2 TOP PIN**

BEB10	100/PKG	BEB19	100/PKG
BEB11	100/PKG	BEB2	100/PKG
BEB12	100/PKG	BEB3	100/PKG
BEB13	100/PKG	BEB4	100/PKG
BEB14	100/PKG	BEB5	100/PKG
BEB15	100/PKG	BEB6	100/PKG
BEB16	100/PKG	BEB7	100/PKG
BEB17	100/PKG	BEB8	100/PKG
BEB18	100/PKG	BEB9	100/PKG

**A2 BOTTOM PIN**

BEA0	100/PKG	BEA5	100/PKG
BEA1	100/PKG	BEA6	100/PKG
BEA2	100/PKG	BEA7	100/PKG
BEA3	100/PKG	BEA8	100/PKG
BEA4	100/PKG	BEA9	100/PKG

**A4 TOP PIN**

BEF1	A4 TOP PIN SEGMENT #1
BEF10	A4 TOP PIN SEGMENT #10
BEF11	A4 TOP PIN SEGMENT #11
BEF2	A4 TOP PIN SEGMENT #2
BEF3	A4 TOP PIN SEGMENT #3
BEF4	A4 TOP PIN SEGMENT #4
BEF5	A4 TOP PIN SEGMENT #5
BEF6	A4 TOP PIN SEGMENT #6
BEF7	A4 TOP PIN SEGMENT #7
BEF8	A4 TOP PIN SEGMENT #8
BEF9	A4 TOP PIN SEGMENT #9

**A4 BOTTOM PIN**

BEE0	A4 BOTTOM PIN SEGMENT #0
BEE1	A4 BOTTOM PIN SEGMENT #1
BEE2	A4 BOTTOM PIN SEGMENT #2
BEE3	A4 BOTTOM PIN SEGMENT #3
BEE4	A4 BOTTOM PIN SEGMENT #4
BEE5	A4 BOTTOM PIN SEGMENT #5

## TOOLS / ACCESSORIES

**THROUGH-BOLT DRILL JIG**

BEKD303

**BEST LPS SPRAY LUBRICANT 6-OZ**

BEDD537

**PIN KITS**

BECD431-2	COMBINATING KIT A2 SYSTEM
BECD431-4	COMBINATING KIT A4 SYSTEM

**MEDECO NON-IC CORE PARTS KIT**

BE1778196

**CORE CAPS / SPRINGS**

BE21C	CORE CAPS
BE22S	CORE SPRINGS

**7 PIN THROW MEMBER**

BEB54200

**CAPPING/DECAPPING BLOCK**

BECD540

**MORTISE CYLINDER WRENCH**

BEED211

**HAND CAPPING PIN**

BECD547

**EJECTOR PIN**

BECD548

**KEY / CORE ENVELOPES**

BE71043360S	KEY
BE71043443S	CORE



**MORTISE/CYLINDERS/HOUSINGS**

- BE1E04RP3626
- BE1E74C4RP3626
- BE1E74C161RP3626
- BE1E74C181RP3626
- BE1E74C208RP3626
- BE1E74C258RP3626
- BE1E74C265RP3626
- BE1E76C181RP1626



**DEADLATCHES**

- BE8KL3626
- BE8KL4626
- BE8KL5626
- BE8KS2626
- BE8T37KSTK626
- BE8T37MSTK626
- BE8T37SSTK626



**RIM/CYL HOUSINGS**

- BE12E02RP32626    1E Dummy Rim Cyl.
- BE12E7252RP626    12E Standard Rim Housing

**PADLOCKS**

- BE21B722L
- BE21B722LWC
- BE21B722TM1
- BE21B772L
- BE21B782L
- BE41B722L
- BE41B782L



**LEVERS**



- BE9K30D15DS3626MED    9K STOREROOM Non-IC OEM
- BE9K30L14DS3626    9K PRIVACY LVR
- BE9K30N14DS3626    9K PASSAGE LVR
- BE9K30L15DS3626    9K PRIVACY LVR
- BE9K30N15DS3626    9K PASSAGE LVR
- BE9K36D15DS362608    9K STOREROOM Non-IC OEM
- BE9K37AB14DS3626    9K ENTRANCE LVR LESS CORE
- BE9K37AB15DS3626    9K ENTRANCE LVR LESS CORE
- BE9K37C15DS3626    9K CORRIDOR LEVER
- BE9K37D14DS3626    9K STOREROOM LVR L/CORE
- BE9K37IN14DS3626    9K INTRUDER LVR LESS CORE
- BE9K37D15DS3626    9K STOREROOM LVR L/CORE
- BE9K37IN15DS3626    9K INTRUDER LVR LESS CORE
- BE9K37R14DS3626    9K CLASSROOM LVR L/CORE
- BE9K37R15DS3626    9K CLASSROOM LVR L/CORE
- BE9KW37DEU15DS3626    9KW ELECTRIC UNLOCKED

**SHACKLES**

- BE11B72L    3/4" Steel Shackle
- BE11B720L    1.5" Bronze Shackle
- BE11B772L    2" Steel Shackle
- BE11B722L    1.5" Steel Shackle
- BE11B782L    4" Steel Shackle

**MORTISE LOCKS**

- BE45H0L15H626RH
- BE45H0N15H626RH
- BE45H7AB15H626RH
- BE45H7D15H626RH
- BE45H7R15H626RH
- BE45HZ7DV14KP626RH



**TRIM CASSETTES**

- BEB45071    INSIDE TRIM CASSETTE - LEVER
- BEB45081    OUTSIDE TRIM CASSETTE - LEVER

## KEY KEEPERS

### KEY STORAGE

*Part Numbers*

BO5620-628

BO5620-988 Key Keeper

BO5641-628 Mounting Collar

*Chain Not Included*

*Allows mailman to enter building. Arrow lock for key keeper door is furnished and installed by the United States Postal Service.*

**SPECIFICATIONS**

- Aluminum
- Dimensions:  
 Frame Size - 4 3/4" High x 6 3/8" Wide  
 Door Size - 2 3/4" High x 4 3/4" Wide  
 Wall Cutout - 3" High x 4 3/4" Wide x 1 3/4" Deep
- Finishes:  
 628 - Anodized Aluminum  
 988 - Gold Anodized Aluminum
- Weight: Approximately 1/2 Lbs



### MAILBOX LOCK

*Part Number*

BO25389

*Used for Couch Mail Boxes w/steel bolt and Flat Steel Key.*

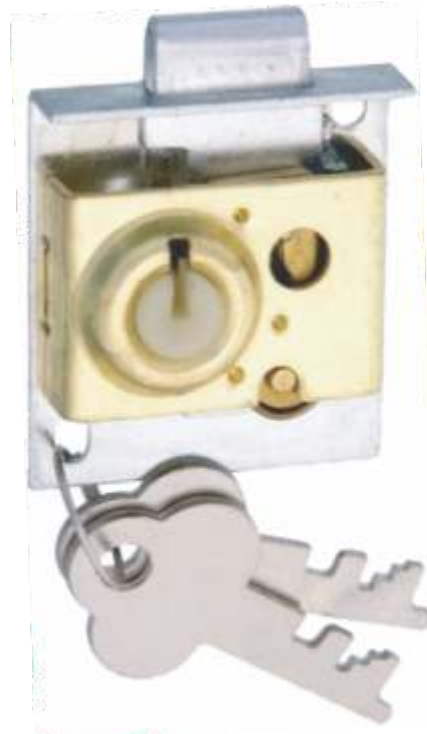



## KNOB SAVER

### KNOB SAVER

*Features:*

- 4" x 15" - 13 1/4" CTC
- Durable .090 Heavy gauge stainless steel
- Simple 2 hole installation with hex bolts that will not collapse a hollow metal door
- Works equally well on wood doors

CL051690



# MAP1 Modular Access Panel

ONE PANEL, *THREE SOLUTIONS!*



## ACCESS CONTROL AS A SERVICE

- 100,000 users - 1024 readers
- Subscription based
- No software to install
- Managed via browser from anywhere

[cansec.com/cloudlock](http://cansec.com/cloudlock)



## CLIENT-SERVER SOFTWARE

- 100,000 users - 1024 readers
- Windows based
- Up to 10 First Access clients
- Automatic panel discovery

[cansec.com/fa](http://cansec.com/fa)



## EMBEDDED WEB SERVER

- 5,000 users - 4 readers
- No software to install
- Built-in web server
- Managed via browser

[cansec.com/webster](http://cansec.com/webster)

*Cutting edge simplicity*®

 [cansec.com](http://cansec.com)    +1 (877) 545-7755    [sales@cansec.com](mailto:sales@cansec.com)

# EXPLORE WHAT'S INSIDE

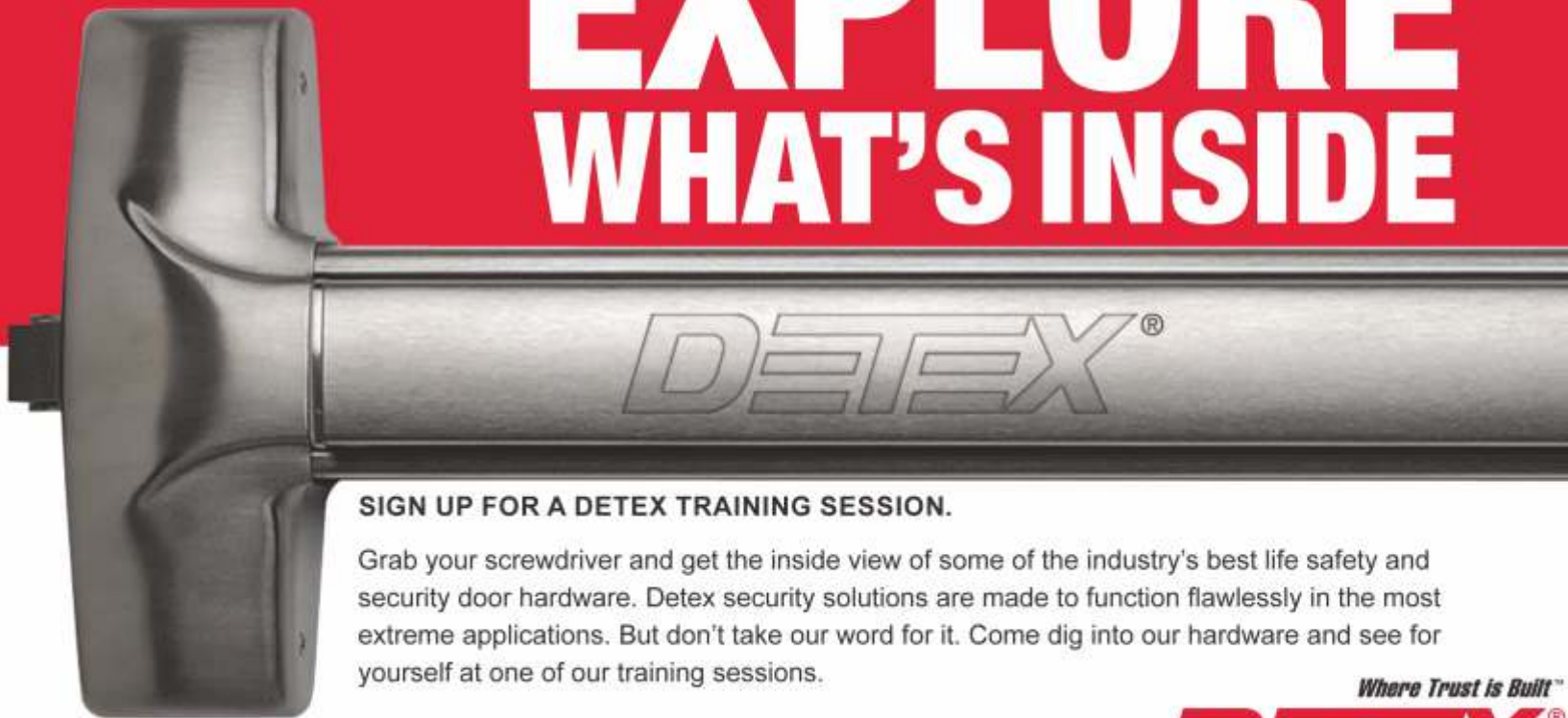

## SIGN UP FOR A DETEX TRAINING SESSION.

Grab your screwdriver and get the inside view of some of the industry's best life safety and security door hardware. Detex security solutions are made to function flawlessly in the most extreme applications. But don't take our word for it. Come dig into our hardware and see for yourself at one of our training sessions.

For a complete list of our training sessions, visit [www.detex.com/training](http://www.detex.com/training) or call 800-729-3839.

*Where Trust is Built™*

**DETEX**®  
*Life Safety, Security and Security Assurance*



**SmartLock Single-Door Add-On Kit**

- Includes:*
- 1 SmartLock controller
  - 1 SmartLock enclosure
  - 1 power supply board with plug-in transformer

CNCA-SLPKCP1P Smartlock Sgl Door Add-On Kit



**SmartLock Single-Door Starter Kit**

- Includes:*
- 1 SmartLock controller
  - 1 SmartLock enclosure
  - 1 power supply board with plug-in transformer
  - 1 CanProx One HID/AWID reader
  - 1 CLAUSB
  - 5 125 kHz HID-compatible cards
  - SmartLock Pro Plus software Free Download

CNCA-SLPSKCP1P Smartlock Sgl Door Starter Kit



**SmartLock Single-Door IP Starter Kit**

- Includes:*
- 3 SmartLock controllers
  - 1 SmartLock enclosure
  - 1 power supply board with plug-in transformer
  - 3 CanProx One HID/AWID readers
  - 1 CLAUSB
  - 10 125 kHz HID-compatible cards
  - SmartLock Pro Plus software Free Download

CNCA-SLPSKCP1PN Smartlock Sgl Door IP Starter



CNCA-CP1R CANPROX ONE Multi-Mount Prox





**CanLan II Network Communications Device**

- RS-485 to TCP/IP communications device.
- Includes plug-in power supply, UTP jack, and RS-485 output.
- Static IP is required.

CNCA-CANLAN2                      Network Communications Device



**CLAUSB Serial Communications Device**

- RS-485 to USB Converter.
- Supports up to 30 SmartLock Pro Plus controllers.

CNCA-CLAUSB                      USB Serial Communications Dev



**SmartLock® Enclosure**

- 241 mm x 330 mm x 76 mm [9.5 in x 13 in x 3 in] metal enclosure with room for 1, 2 or 3 SmartLock Pro Plus controllers, Cansec power supply and 12V 7AH battery.
- Now comes with key lock and CanLan2 mounting location.

CNCA-SLBOX                      SmartLock Enclosure



**SmartLock® Pro Plus Controller**

- Supports a single door with Entry and Exit readers and up to 4800 users. Provides relay outputs for lock control, handicap door operator, and door-held-open/forced entry.
- Supports inputs for request-to-exit and door contact.
- All controller terminations are on detachable headers for ease of installation and service.
- Self-resetting fuses. Buffers up to 1,000 transactions.
- Requires 12 VDC. Includes push-in stand-offs.

CNCA-SLPCNPP                      SmartLock Sgl Door Controller

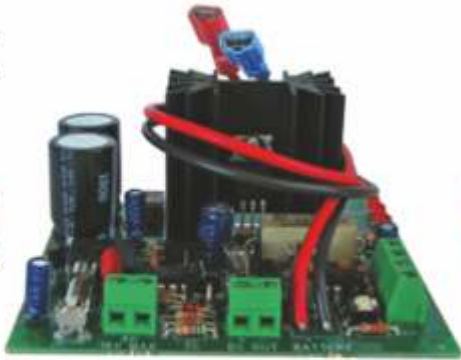

CNCA-PS123A

Power Supply Board W/ Onboard



**CanProx Thin Proximity Card**

• Slot punched with Cansec logo (.030" thick)

CNCA-CP2BT-H37

Canprox Card HID 37-BIT



**CanProx Key II**

• Extra thin fob-style credential  
• Attaches to key ring with brass eyelet

CNCA-CP2KT-H37

Canprox Key II HID 37-BIT

## CAM LOCKS



- Features:**
- Capable of being keyed alike and master keyed
  - Cam may be mounted in four positions. Regular rotation from 12 to 9 o'clock

CRB15751-KD-US26D  
 CR15751-C2L-180-CAT167  
 CR15752-C2L-180-CAT103  
 CR15753-C2L-180-CAT-60  
 CRK15760  
 CRK15760A-KA-CAT-30

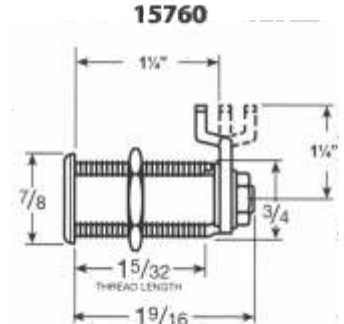
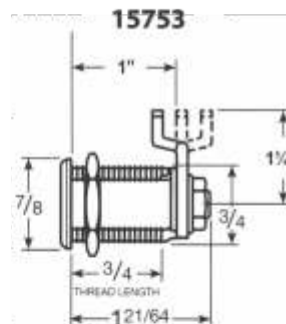
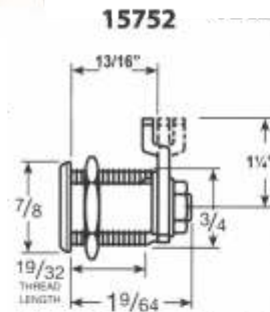
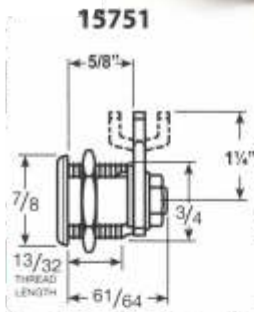

## MAILBOX LOCK

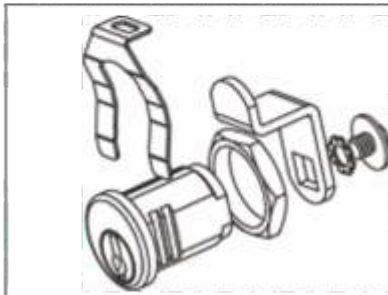

- Features:**
- Nut or clip mounted
  - 90° counter-clock-wise cam turn to open
  - Key retaining
  - Supplied with 1/2ve cams, two keys, mounting nut, mounting clip, lock washer and cam screw

CRMBL82010

## DISC TUMBLER DRAWER LOCKS

**02068 DEAD BOLT**

- Features:**
- Can be masterkeyed
  - Brass plated steel
  - To remove plug, insert key and rotate 90°. Insert end of small tool (e.g., paper clip) into access hole and depress retainer while pulling key and plug out

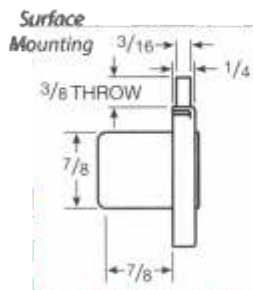

**02068 1/2 LATCH BOLT (includes strike)**

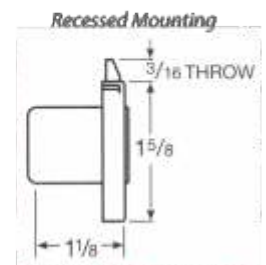

- Features:**
- Cannot be master keyed
  - Brass



CR02068-7/8-US4-KD  
 CR02068-1/2-7/8-US4-KA

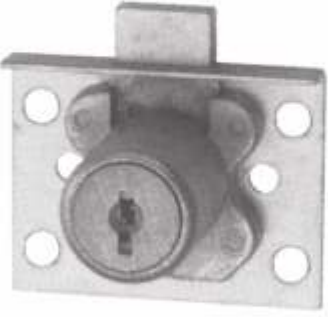
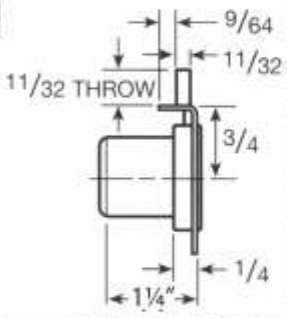

**DISC TUMBLER DRAWER LOCKS**

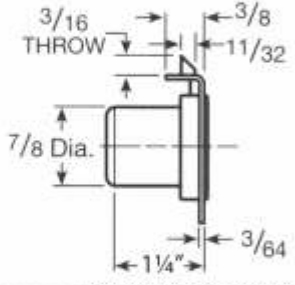
<p><b>02065 DEAD BOLT</b></p> <p>CR02065-7/8-US4 CR02065-7/8-US4-CAT-45</p> <p>Features: • Brass Plated Steel • 7/8" Can be Masterkeyed</p>   <p>Mortise Mounting</p>	<p><b>02065 1/2 LATCH BOLT</b> (includes strike)</p> <p>CR02065-1/2-CAT30-7/8"</p>   <p>Mortise Mounting</p>
---	---

**DISC TUMBLER DRAWER LOCKS**

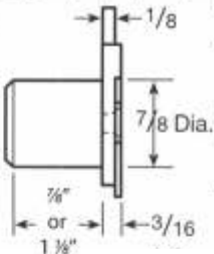
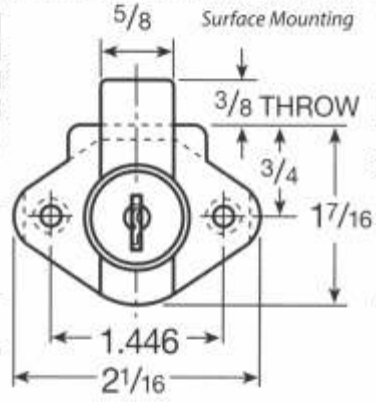
<p><b>02066 DRAWER LOCK</b></p> <p>Features: • Brass Plated Steel • Can be master keyed</p> 	<p>CR02066-1-1/8-US4 CR02066-1-1/8-US4-CAT9 CR02066-7/8-US4 CR02066-7/8-US4-CAT-30</p> 	<p>Surface Mounting</p> 
--	--	--

**PIN TUMBLER DRAWER LOCKS**

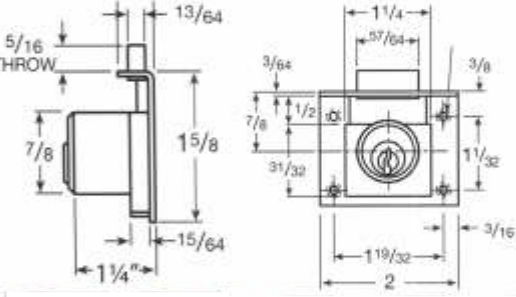
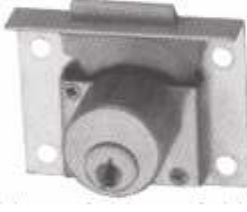
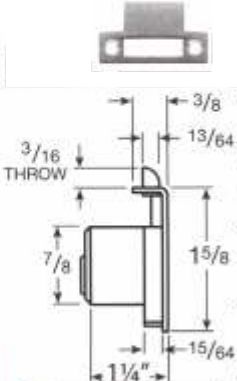
<p><b>0666 DEAD BOLT</b></p>   <p>Mortise Mounting</p> <p>Features: • Key can be removed in either locked or unlocked position on 0666 only • R1 &amp; CR Keyways • All Brass</p> <p>CR0666-7/8-US4-KA</p>	<p><b>0666-1/2 LATCH BOLT</b> (includes strike)</p>   <p>Mortise Mounting</p> <p>Features: • Brass, regularly furnished</p> <p>CR0666-1/2-7/8-US4-KA-Key 4T27660</p>
--	---

## ELECTRICAL PANEL LOCK



(Right Hand Shown)

**Features:**

- Disc Tumbler can be masterkeyed

CR15767-26D-CAT-60-LH  
 CR15767-26D-CAT-60-RH  
 CR15767-26D-WEM-1-RH

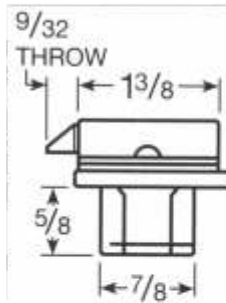

## PADLOCKS

### Sesame Padlock-A/Weather BLK EPOXY

**Features:**

- 10,000 possible combinations heel and toe locking
- All Brass Internal locking mechanism
- Automatic "0000" stop
- The combination is quickly and easily set



CRK436 1" SHKL  
 CRK437 2 1/8" SHKL

### Sesame Padlock-A/Weather US4



CRK500-3/4" — 1" SHKL

## KEYLESS CAM LOCKS

### CK2113 KEYLESS COMBINATION CAM LOCKS

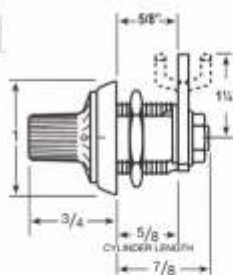

CRCK2113-26D-KD 5/8" Combination

### DIAL COMBO CAM LOCK

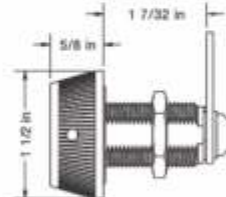
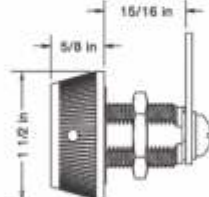
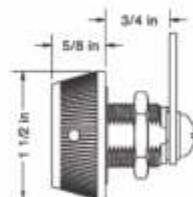

CR39051 3/4"  
 CR39052 15/16"  
 CR39053 1 1/2"

### KEY BLANKS

CR4193C-AR	Key Blank 5-Pin	CR5865-JVL	Key Blank 5-Disc	CR8632C-R1	Key Blank 4-Pin
CR5860-KS	Key Blank 5-Disc	CR5865-JVR	Key Blank 5-Disc	CR8658-JVL	Key Blank 6-Disc
CR5861-KM	Key Blank 6-Disc	CR8618C-CR	Key Blank 5-Pin	CR8658-JVR	Key Blank 6-Disc
CR5861-KS	Key Blank 5-Disc	CR8618C-VL	Key Blank 5-Pin	CR8687C-CR	Key Blank 6-Pin
CR5865-JR	Key Blank 5-Disc	CR8632C-CR	Key Blank 4-Pin		

## ENERGY TRANSFER HINGES

**Features:**

- UL Listing - 60LK Flexible Connector
- Center Located wire access holes for easy installation (Standard Weight Hinges)
- Rated up to 5 amps continuous at 12V or 24V
- 19 strand wire on 2, 4, & 8 wire models assure long hinge life
- Drilling template and instructions
- 3 Year Warranty

**5 KNUCKLE STANDARD WEIGHT HINGE  
(Brand: Hagar BB1279)**
**4.5 x 4.0 Round Corner**
**2-Wire**

CAETH2WH4540R-613

CAETH2WH4540R-626

**4-Wire**

CAETH4W4540R-613

CAETH4W4540R-626

**8-Wire**

CAETH8W4540R-613

CAETH8W4540R-626

**4.5 x 4.5 Square Corner**
**2-Wire**

CAETH2WH4545-613

CAETH2WH4545-626

**4-Wire**

CAETH4W4545-605

CAETH4W4545-606

CAETH4W4545-612

CAETH4W4545-613

CAETH4W4545-625

CAETH4W4545-626

**8-Wire**

CAETH8W4545-626

**4.5 x 4.5 Square Corner**
**5 KNUCKLE HEAVY WEIGHT HINGE  
(Brand: Hagar BB1168)**
**4-Wire**

CAETH4W45451168-626

**HINGE(HW) 4.5 X 4.5 STEEL**

CAETH4WH4545-626 BB68

**HINGE(HW) 4.5 X 4.5 STAINLESS**

CAETH4WH4545-630 BB99

## ELECTRIFIED MORTISE LOCKS

**Features:**

- UL Listed Locks 58LK (Electrically Controlled Single Point Lock)
- Available Fail Safe (Power Lock) or Fail Secure (Power Unlock)
- Continuous duty solenoids internally mounted for easy of installation
- Current draw - 12V-600 milliamps 24V 300 milliamps
- Available voltage - 12V and 24V models AC/DC
- Built in rectifier for AC or DC operation
- 3 Year Warranty

**Electrically Unlocked**

CAML05EUCH-24AC/DC

CAML80EUCH-12AC/DC

CAML80EUCH-24AC/DC

Corbin ML2057EU Chassis

Schlage L9080EU Chassis

Schlage L9080EU Chassis

**Electrically Locked**

CAML80ELCH-24AC/DC

Schlage L9080EL Chassis

**Electrified Mortise Chassis**

CAML180ELCH-24V

CAML180ELCH-24V-REX

CAML180EUCH-12V

CAML180EUCH-24V

CAML180EUCH-24V-REX

CALPM180EUCH-24V

## ELECTRIFIED CYLINDRICAL LEVER



- ANSI grade 1
- 12/24 AC/DC
- Continuous duty solenoids for cooler operation during "continuously on" applications
- Available with "fail safe" or "fail secure" function

**Electrically Unlocked**

CAACLN80LEURH24-626-REX

**FIELD TESTERS**

CA79597

CA79598

CA79599

CA79618

CA79619

CA79620

CA79621

AVAD-35

AVADC-116

C.A. Field Tester DeWalt

C.A. Field Tester Makita

C.A. Field Tester Milwaukee

CAT Field Tester Base Only

CAT Attachment Only - DeWalt

CAT Attachment Only - Makita

CAT Attachment Only - Milwaukee

Coil Detect/Remote Tester

OBD2 Port Tester Adapter





## POWER SUPPLIES



**Features:**

- Perfect for powering Electric Latch Retracting Exit Devices
- Raw, unregulated DC - ideal for the extreme in-rush most solenoid driven devices require

CAPS1	Power Supply (1 ELR)
CAPS210	Power Supply 1.5A 24V Regulate
CAPS220	Power Supply (2 ELR)
CAPS220B	Power Supply (2 ELR)
CADS1	Delay/Sequencer Board
CAVD2	2 Channel Input/Output Board

**VOLTAGE CONVERTER MODULE**  
CAVC2412



## POWER ACCESSORIES

<p><b>CRU3</b></p> 	<p><b>Features:</b></p> <ul style="list-style-type: none"> <li>• Allows "continuously on" low current devices to run cooler, increasing the life of the solenoid and reducing service calls</li> <li>• Provides a small current boost to offset some of the voltage loss associated with long wire runs</li> <li>• Current adjustment allows for "fine tuning"</li> </ul>	<p>CACRU2 CACRU3 CAVDREXKIT-ED Field Request To Exit Kit</p>																
<p><b>POWER BOOSTER MODULE</b></p> 	<p><b>Features:</b></p> <ul style="list-style-type: none"> <li>• Fits inside of a Von Duprin, Doromatic or Command Access modified electric latch pull-back exit device</li> <li>• Maximizes the efficiency and life of the solenoid and allows for a much longer wire run (typically 500'+ with 18/2 wire)</li> </ul>	<p>CAPM300</p>																
<p><b>DOOR LOOP</b></p> 	<p><b>Features:</b></p> <ul style="list-style-type: none"> <li>• Slides into the door and/or frame completely concealing itself when the door is closed</li> </ul>	<p>CACDL-A Alum CACDL-B Black</p>																
<p><b>ELECTRIC LATCH RETRACTION KIT</b></p> 	<p><b>Features:</b></p> <ul style="list-style-type: none"> <li>• Convert a mechanical Von Duprin 33/35 or 98/99 series exit device to an electrified device by simply replacing the mechanical baseplate</li> <li>• Six foot long 2-wire cable with PM300 connector</li> <li>• No hassle 3-Year Warranty</li> </ul>	<p><b>Specifications:</b></p> <ul style="list-style-type: none"> <li>• Voltage - 24VDC</li> <li>• Amperage - Surge current - 12A for 200ms@24V / Holding - 250 mA@24V</li> <li>• Solenoid coil resistance - 2 Ω</li> <li>• Includes PM300</li> </ul> <p>CAVLPKIT36 ELR Kit 36" CAVLPKIT48 ELR Kit 48" CAPD10-UL-M-KIT CAPD15-UL-M-KIT</p>																
<p><b>MOTORIZED LATCH PULLBACK KIT</b></p> 	<p><b>Features:</b></p> <ul style="list-style-type: none"> <li>• Electric controlled dogging</li> <li>• On Board Diagnostics (monitoring)</li> <li>• Up to 700' wire run with 2/18 wire</li> <li>• 3-year "no hassle" warranty</li> </ul>	<p><b>Specifications:</b></p> <ul style="list-style-type: none"> <li>• Operating Voltage range - 22 to 30 VDC</li> <li>• System protection - unit shutdown when voltage exceeds 31VDC</li> <li>• Current Peak - 1A</li> <li>• Current Hold - 125mA</li> </ul> <p>CAVLP-UL-M-KIT CAARLP-UL-M-KIT CACYLP-UL-M-KIT CAPD10-UL-M-KIT CAPD15-UL-M-KIT CASLP-UL-M-KIT</p>																
	<p>CAEXARLP-UL-M-KIT Adams Rite EX Motor Drive Kit</p>	 <p>CAEDLP2-UL-M-KIT USCAN 2100 Motor Drive Kit</p>																
<p><b>CVR EXIT MOTOR-DRIVEN</b></p>  <p>CAPD10-M-CVRA-36 CAPD10-M-CVRD-36</p>	<p><b>RIM EXIT MOTOR DRIVEN</b></p> <table border="0" style="width: 100%;"> <tr> <td>CAPD10-M-RIMA-36</td> <td>ALUMINUM</td> <td>CAPD15-M-CVR-D-LHR-EU24</td> <td>DURO</td> </tr> <tr> <td>CAPD10-M-RIMD-36</td> <td>DARK BRONZE</td> <td>CAPD15-M-CVR-D-RHR-EU24</td> <td>DURO</td> </tr> <tr> <td>CAPD15-M-CVR-A-LHR-EU24</td> <td>ALUMINUM</td> <td>CAPD15-M-RIM-A-EU24</td> <td>ALUMINUM</td> </tr> <tr> <td>CAPD15-M-CVR-A-RHR-EU24</td> <td>ALUMINUM</td> <td>CAPD15-M-RIM-D-EU24</td> <td>DURO</td> </tr> </table> <p><b>MOTOR DRIVEN CVR EXIT DEVICE</b> CAPD25-M-SVR-36-626</p>	CAPD10-M-RIMA-36	ALUMINUM	CAPD15-M-CVR-D-LHR-EU24	DURO	CAPD10-M-RIMD-36	DARK BRONZE	CAPD15-M-CVR-D-RHR-EU24	DURO	CAPD15-M-CVR-A-LHR-EU24	ALUMINUM	CAPD15-M-RIM-A-EU24	ALUMINUM	CAPD15-M-CVR-A-RHR-EU24	ALUMINUM	CAPD15-M-RIM-D-EU24	DURO	
CAPD10-M-RIMA-36	ALUMINUM	CAPD15-M-CVR-D-LHR-EU24	DURO															
CAPD10-M-RIMD-36	DARK BRONZE	CAPD15-M-CVR-D-RHR-EU24	DURO															
CAPD15-M-CVR-A-LHR-EU24	ALUMINUM	CAPD15-M-RIM-A-EU24	ALUMINUM															
CAPD15-M-CVR-A-RHR-EU24	ALUMINUM	CAPD15-M-RIM-D-EU24	DURO															

**FILE CABINET LOCKS**

**Features:**

- Four pin tumbler plug
- Die cast barrel with die cast bolt
- No. 5002LP has rectangular bolt
- Other models have round bolt
- Standard Finish - Satin Chrome
- Two keys furnished per lock

Lock No.	"A" Dim.	"Bolt" Dim.	"D" Dim.	"O.A." Dim.	"W" Dim.
<b>CEXP-19DC</b>	7/8"	1/4" dia.	N/A	1 3/4"	N/A
<b>N6-5001</b>	55/64"	9/32" dia.	1/2"	1 3/4"	1/8"
<b>C5001LP</b>	55/64"	9/32" dia.	5/16"	1 3/4"	5/32"
<b>C5002LP</b>	1 7/64"	27/64" x 9/64"	5/16"	2"	5/32"



CHCEXP-19DC-KD KD  
CHCEXP-19DC-5X75 KA



CHN6-5001-050-0-K91-JP KD  
CHN6-50010500K91TP1X20 KA  
CHN6-50010500K91TP3X5 KA



CHC5001LP-KD KD  
CHC5001LP-1X20 KA  
CHC5001LP-3X5 KA



CHC5002LP-KD KD  
CHC5002LP-1X20 KA  
CHC5002LP-3X5 KA

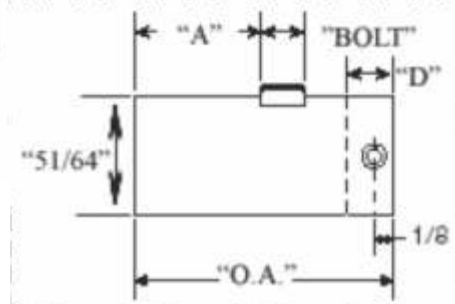
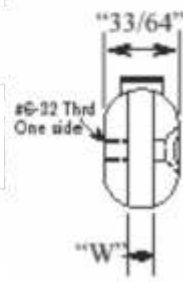
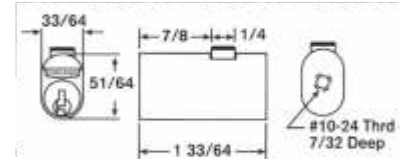

**CAM LOCKS**

**SINGLE BITTED**

CHC3786-1289 5/8"



**Features:**

- Five disc tumbler plug in 3/4" diameter
- Die cast barrel with two lats - 5/8" across
- Key and cam rotation 90° from locked (12 O'clock) to unlocked (3 O'clock) position with keypull in locked position only
- Straight cam furnished is 1/8" thick X 3/4" wide
- Standard Finish - Polish Nickel
- Two keys furnished per lock

CHC1701-1454 9/16"  
CHC1704-1289 1 1/2"

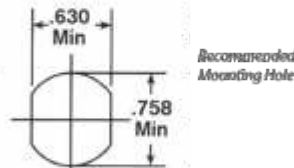
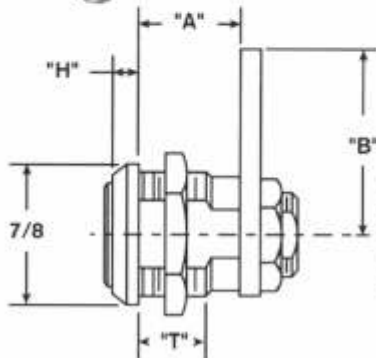
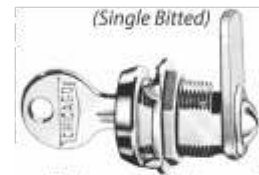

Lock No.	"A" Dim.	"B" Dim.	"H" Dim.	"T" Dim.
<b>C3786</b>	5/8"	1 1/2"	13/64"	13/32"
<b>C1701</b>	13/16"	1 1/2"	13/64"	11/16"
<b>C1704</b>	1 1/2"	1 1/2"	13/64"	1 1/2"

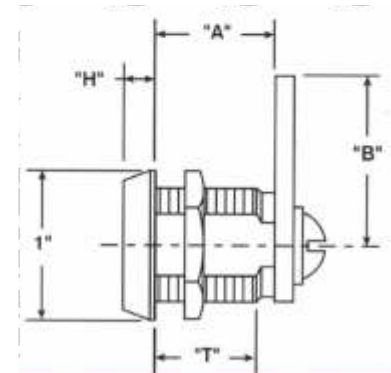

## CAM LOCKS — continued



**Keyway D137-CLC  
C4152**

CHC4152-KD	15/16"
CHC4152-PL505	15/16"
CHC4153-KD	11/16"
CHC4153-PL505	11/16"
CHC4153-7302	11/16"
CHD137-CLC	Keyblank

### Ace II® Universal Function Locks

**Features:**

- Ace II cylinder - 3/4" diameter with 2 flats - .625 across
- All brass components and brass outer barrel
- Center plug contains anti-drill pin for added security
- Standard key and cam rotation is 90° from locked (12 O'clock) to unlocked (3 O'clock) position with keypull in locked position only
- Standard Finish - Polish Nickel
- Straight cam furnished with "B" dimension of 1 1/8" for vertical or horizontal mounting
- Two keys furnished per lock with shake-proof washer and hex nuts
- Number stamped on key tag, not on lock

### C4152 & C4153

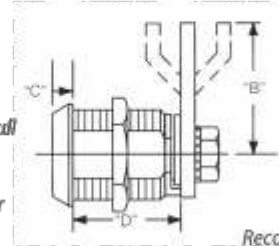

*Recommended  
Mounting Hole*

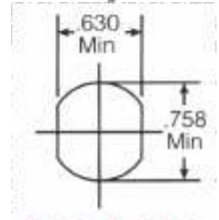

Lock No.	"B" Dim.	"C" Dim.	"D" Dim.
<b>C4152</b>	1 3/8"	13/64"	15/16"
<b>C4153</b>	1 3/8"	1/4"	11/16"



## BOLT TYPE LOCKS

### Bolt Type Locks

- Five disc tumbler
- Removable plug feature
- Steel locking bolt
- Two keys furnished per lock

Lock No.	"A" Dim.	"D" Dim.
<b>C1968</b>	57/64"	1 5/32"
<b>C1974</b>	19/32"	27/32"
<b>C1975</b>	21/32"	57/64"

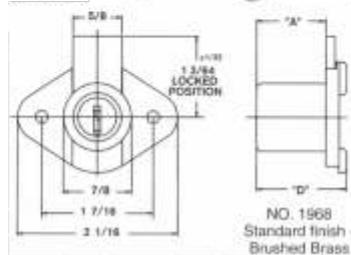

NO. 1968  
Standard Finish -  
Brushed Brass

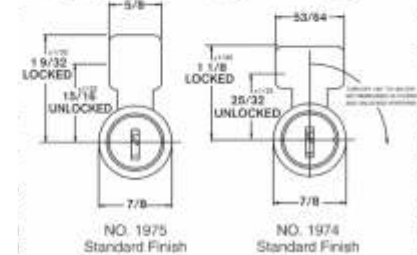

NO. 1975  
Standard Finish  
Satin Chrome

NO. 1974  
Standard Finish  
Satin Chrome

**C1968**

CHC1968-KD	57/64"
CHC1968-1289	57/64"
CHC1968-1454	57/64"

**C1974**

CHC1974-KD	19/32"
CHC1974-1289	19/32"
CHC1974-1454	19/32"

**C1975**

CHC1975-KD	21/32"
CHC1975-1454	21/32"

## POP-OUT 'T' HANDLE

### 4200 T-Handle



**Keyway  
D137-CLC**

### 4200 Series Retrofits "T" Handle

**Features:**

- Actual Handle ships with Ace Cylinder and 2 keys
- Less Cam
- Increases security for limited spaces
- Accepts standard and long cylinder locks which meet NAMA dimensional standards
- Available in 1/4 turn, clockwise or counter-clockwise
- Locking cams can be manufactured per customer requirement
- Available 90° and 180° rotation
- Textured finish for scratch resistance
- Standard Finish - Chrome

### Handle and Cylinder Dimensions

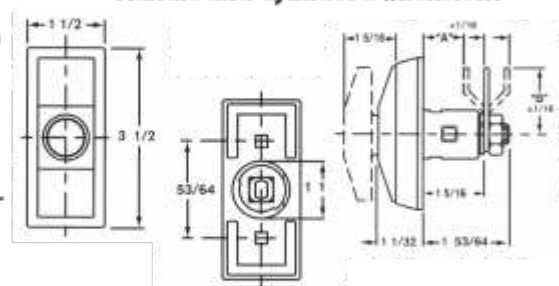

CHR242000010K90JI 4200 T-Handle KD W/ACE2K



## SLIDING DOOR LOCKS

### C1770 SINGLE BITTED



CHC1770-KD Sliding Door Lock

### SLIDING DOOR LOCK

- Five disc tumbler plug in 7/8" diameter
- Die cast barrel
- No. 1770 utilizes a spring bolt which locks by pushing the cylinder in and released by turning the key 90° from locked (12 O'clock) to unlocked (3 O'clock) position
- Keypull in locked and unlocked positions
- Standard Finish - Satin Chrome
- Mounting plate is 5/64" x 7/8" x 2" with 1-1/2" between mounting hole centers
- Furnished with two keys per lock

### C1770 Dimensions

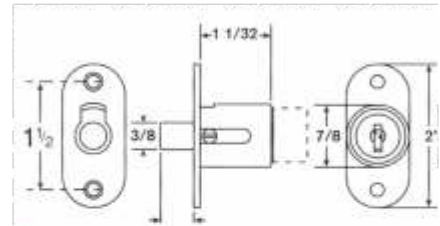

1 1/2" At Locked Position

## SWITCH LOCKS

### C2174 Series DOUBLE BITTED



CHC2174-1DC-KD	1 Pull
CHC2174-1DC-2001	1 Pull
CHC2174-2DC-KD	2 Pull
CHC2174-2DC-2001	2 Pull
CHC2174-2DC-2007	2 Pull
CHC2174-70DC-KD	Momentary
CHC2174-70DC-2001	Momentary
CHC2174-70DC-2007	Momentary
CHC2174-70DC-2126	Momentary

### SINGLE POLE, SINGLE THROW SWITCH LOCKS

- Features:**
- Double bitted assembly with eleven crisscross blade tumblers
  - Lock operation same as 4073 Series
  - Contact configuration: SPST
  - 7 amps (resistive) @ 125 Volts A.C.
  - 7 amps @ 28 Volts D.C.
  - Electrical Life: 6,000 cycles @ Max. Load
  - Contact resistance: 50 milli ohms initial maximum
  - Standard Finish - Bright Chrome
  - Two keys furnished per lock
  - Switches are U.L. Recognized

### Double Bitted Keyswitches - SPST

Lock No.	Keypull	Contact
C2174-1DC	OFF Only	Maintaining
C2174-2DC	OFF & ON	Maintaining
C2174-70DC	OFF Only	Momentary

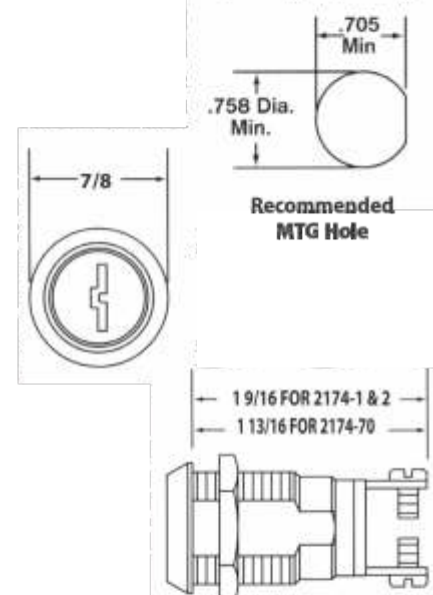

Keyway D137-CLC

CHC4073-2DC-KD	2 Pull
CHC407370DC-PL927	Momentary
CHD137-CLC	Keyblank

### SINGLE POLE, SINGLE THROW SWITCH LOCKS

- Features:**
- Patented Ace II Lock Assembly
  - Maintaining contact switch operated by manually rotating inserted key 90° clockwise from open to closed position
  - Contact configuration: SPST
  - 7 amps (resistive) @ 125 Volts A.C.
  - 7 amps @ 28 Volts D.C.
  - Electrical Life: 6,000 cycles @ Maximum Load
  - Contact resistance: 50 milli ohms initial maximum
  - Request Standard ESP-EL1000 for complete details
  - Standard Finish - Bright Chrome
  - Two keys furnished per lock
  - Switches are U.L. Recognized

Lock No.	Keypull	Contact
C4073-2DC	OFF & ON	Maintaining
C4073-70DC	OFF Only	Momentary

### C4073 Dimensions

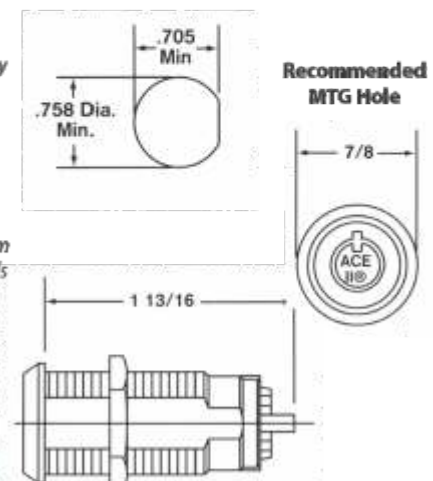

## SCREWTYPE LOCKS

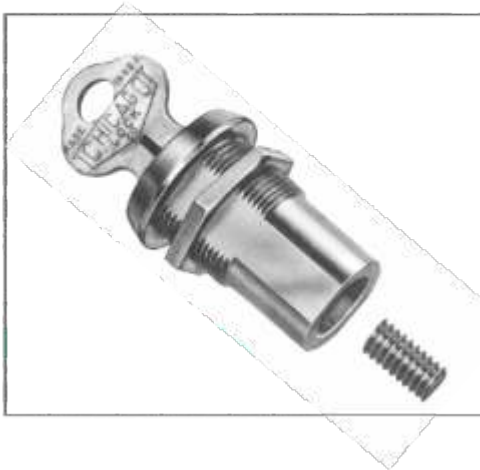

*Years of lock engineering and manufacture by one of the oldest lock companies in the middle west are built into CompX Chicago locks. Experience, and organization of skilled personnel and the best of materials make Chicago locks what they are.*

*The threaded rod is anchored to base of machine on these Screwtype, Gum Ball locks.*

### Screwtype Gum Ball Lock Tapped 1/4" x 20

CH3274-40-KA  
CH3274-40-KD

## LOCK ACCESSORIES



CHD9094 Single Bitted Service Kit



CHD9655-WC Weather Cover

### D9655-WC Weather Cover for Camlocks

**Protect Switch Locks and Cam Locks from the elements with this economical, easy to install weather cover.**

- Quality construction includes:*
- Chrome plated zinc die cast cover.
  - Stainless Steel mounting ring.
  - Permanently installed rubber seal.
  - Positive spring closure to insure seal integrity.

## KEY BLANKS

CHDK-100-MH	CHDK-4-W
CHDK-101-H	CHDK-5
CHDK-102-H	CHDK-501
CHDK-103-H	CHDK-502
CHDK-104-H	CHDK-503
CHDK-2-W	CHDK-504
CHDK-35	CHDK-9
CHDK-35-M	CHDK-P-1
CHDK-39	CHDK-P-2
CHDK-4	CHDK-P-3
CHDK-4-L	CHDK-P-9
CHDK-4-R	CHD137-CLC KEY BLANK ACE II

## ELECTRONIC LOCKS

The CompX eLock is the highly engineered electronic lock that's built to interface with solenoid and motor driven latches. Its uncompromising lock control electronics include a non-volatile memory that stores user codes, supervisor codes, and audit trails. With optional LockView™ programming software, programming is made easy. The eLock can also be programmed manually by presenting a supervisor's credential.

EL-KP-CAB



Numeric Keypad	
Part No.	Description
CEEL-KP-CAB	The numeric keypad eLock provides authorization with a PIN code of variable length.

EL-MS-CAB



Magstripe Card	
Part No.	Description
CEEL-MS-CAB	The Magstripe Card eLock is designed for secure confirmations with existing mag stripe cards, including credit cards.

EL-PR-CAB



Prox Reader	
Part No.	Description
CEEL-PR-CAB	The Prox Reader eLock is easy to use. Just wave the card and enter. Uses standard HID proximity cards.

EL-MSKP-CAB



Magstripe/ Keypad Combination	
Part No.	Description
CEEL-MSKP-CAB	The combination Magstripe/ Keypad provides an additional level of security, requiring a card to be presented and a PIN code to be entered. Perfect for applications requiring conformance to new security directives.

EL-PRKP-CAB



Prox Reader/ Keypad Combination	
Part No.	Description
CEEL-PRKP-CAB	The combination Prox Reader/ Keypad provides an additional level of security, requiring a card to be presented and a PIN code to be entered. Perfect for applications requiring conformance to new security directives.

### TOTALLY SECURE OPERATION

When a valid credential is detected, the green LED illuminates, the locking mechanism opens and there is a positive confirmation beep. If an invalid credential is entered, the red LED illuminates, and there is a negative beep.



**REFRIGERATOR KITS**



Kits	
Part Number	Description
<b>CEEL-AJSTRIKE-KIT</b>	Adjustable Strike Kit
<b>CEEL-KP-FRKIT</b>	Refrigerator Kit with KP Unit, mounting plate, latch & battery pack
<b>CEEL-KP-TEMP</b>	Temperature Monitoring Refrigerator Kit, Keypad
<b>CEEL-KP-TEMP-U</b>	Temperature Monitoring Unit Only; Keypad
<b>CEEL-MSKP-FRKIT</b>	Refrigerator Kit with MSKP Unit, mounting plate, latch & battery pack
<b>CEEL-MSKP-TEMP</b>	Temperature Monitoring Refrigerator Kit, Magstripe/Keypad
<b>CEEL-PR-FRKIT</b>	Refrigerator Kit with PR Unit, mounting plate, latch & battery pack
<b>CEEL-PRKP-FRKIT</b>	Refrigerator Kit with PRKP Unit, mounting plate, latch & battery pack
<b>CEEL-PRKP-TEMP</b>	Temperature Monitoring Refrigerator Kit, Proximity/Keypad

**MISCELLANEOUS**



LockView™ is a Windows® based system that allows easy database manipulation, access rights changes, and downloading of audit trails.

CEEL-LOCKVIEW-3 LockView  
CEEL-LOCKVIEW-4 LockView 4.1



**EL-2004-MSC**  
Magstripe Card



**EL-2004-PC**  
Proximity Card



**EL-LATCH-3**  
Motorized Latch



**EL-2004-RJKIT**  
RJ11 Extension

**Assorted Parts for E-Lock**

Part Number	Description
<b>CEEL-BIT-15</b>	Torx Head Bit for Fridge
<b>CEEL-DRV-15</b>	Torx Head Driver for Fridge
<b>CEEL-VHB-KIT</b>	Adhesive Kit for Glass & Porous Surfaces
<b>CEEL-STRK-FRKIT</b>	Fridge Kit for 8" Strike Assembly
<b>CEEL-XLSTRK-FRKIT</b>	Fridge Kit for 14" Strike Assembly
<b>CEEL-LATCH-3</b>	Motorized Latch
<b>CEEL-2004-ACWB(12V)</b>	AC Adapter: Use with 12 Volt Strikes Only
<b>CEEL-2004-KPU</b>	E-Lock Keypad Only
<b>CEEL-2004-LC</b>	Latch Cable 24"
<b>CEEL-2004-MSKP-U</b>	E-Lock: Keypad & Mag
<b>CEEL-2004-MSU</b>	E-Lock: Magstripe
<b>CEEL-2004-PRKP-U</b>	E-Lock: Prox/Keypad
<b>CEEL-2004-PRU</b>	E-Lock: Proximity
<b>CEEL-2004-PT</b>	HID Proximity Tag
<b>CEEL-2004-RJKIT</b>	RJ11 Extension
<b>CEEL-2004-9VWB(9V)</b>	AC Adapter: Use with CompX Latch
<b>CE220812010000J</b>	Replacement Keypad 100 Series E

## CAM LOCKS

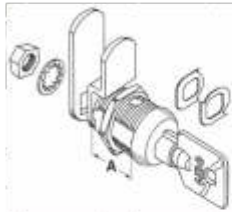

### High Security Tubular Key Locks GEM 1000 Series Locks - 7 Pin Tumbler

**MULTI-FUNCTION**  
**Keyway K137**

The multi-function MFW1000 series locks have been furnished with a retainer pin tapped for a 4-40 threaded screw. Continued turning of a screw into the retaining pin will drive the retaining pin out. The spindle assembly can then be removed from the rear of the lock shell.

**MFW 1038**  
FLMFW1038-KA-27379  
FLMFW1038-KA-27380  
FLMFW1038-KA-27381  
FLMFW1038-KA-27382  
FLMFW1038-KA-27383  
FLMFW1038-KA-27384  
FLMFW1038-KA-27385  
FLMFW1038-KD

**MFW 1058**  
FLMFW1058-KA-27379  
FLMFW1058-KA-27380  
FLMFW1058-KA-27381  
FLMFW1058-KA-27382  
FLMFW1058-KA-27383  
FLMFW1058-KA-27384  
FLMFW1058-KA-27385  
FLMFW1058-KD

**MFW 1078**  
FLMFW1078-KA-27379  
FLMFW1078-KA-27380  
FLMFW1078-KA-27381  
FLMFW1078-KA-27382  
FLMFW1078-KA-27383  
FLMFW1078-KA-27384  
FLMFW1078-KA-27385  
FLMFW1078-KD

**MFW 1118**  
FLMFW1118-KA-27379  
FLMFW1118-KA-27380  
FLMFW1118-KA-27381  
FLMFW1118-KA-27383  
FLMFW1118-KA-27384  
FLMFW1118-KA-27385  
FLMFW1118-KD

**MFW 1148**  
FLMFW1148-KA-27379  
FLMFW1148-KA-27380  
FLMFW1148-KA-27381  
FLMFW1148-KA-27383  
FLMFW1148-KA-27384  
FLMFW1148-KA-27385  
FLMFW1148-KD

Cam Locks - Nickel Plated Includes 1 1/4" Straight Cam And 1 1/2" x 1/4" Offset Cam		
MODEL NO.	DESCRIPTION	TUMBLER MECHANISM
MFW 1038	1/2" 'A' Dimension	
MFW 1058	3/32" 'A' Dimension	
MFW 1078	3/16" 'A' Dimension	
MFW 1118	1 1/2" 'A' Dimension	
MFW 1148	1 1/2" 'A' Dimension	

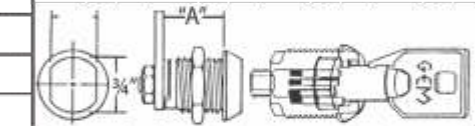

CONVERTABLE FUNCTIONS				
Function	Key Rotation from 12 o'clock position to:	Key Removable at:	Use Cam Stop	Insert Spline Filler at:
1	3 o'clock	12 only	90° right	3 o'clock none
2	3 o'clock	12 and 3	90° right	3 o'clock none
3	6 o'clock (R)	12 and 6	180° right	3 o'clock none
4	9 o'clock	12 only	90° left	9 o'clock none
5	9 o'clock	12 and 9	90° left	9 o'clock none
6	6 o'clock (L)	12 and 6	180° left	9 o'clock

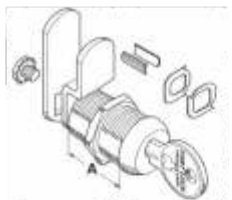

### Single Bitted Cam Locks with Universal Keyway - 23000 Series Locks

**MULTI-FUNCTION**  
**Keyway K54G**

The multi-function MFW23000 series cam locks are engineered to accommodate other manufacturers key blanks. This gives you the opportunity to furnish your customers with additional cam locks keyed into existing key systems (54G Keyway).

**MFW 23038**  
FLMFW23038-KA-217  
FLMFW23038-KA-221  
FLMFW23038-KA-224  
FLMFW23038-KA-237  
FLMFW23038-KA-238  
FLMFW23038-KD

**MFW 23078**  
FLMFW23078-KA-217  
FLMFW23078-KA-221  
FLMFW23078-KA-224  
FLMFW23078-KA-237  
FLMFW23078-KA-238  
FLMFW23078-KD

**MFW 23138**  
FLMFW23138-KA-217  
FLMFW23138-KA-221  
FLMFW23138-KA-224  
FLMFW23138-KA-237  
FLMFW23138-KA-238  
FLMFW23138-KD

**MFW 23058**  
FLMFW23058-KA-217  
FLMFW23058-KA-221  
FLMFW23058-KA-224  
FLMFW23058-KA-237  
FLMFW23058-KA-238  
FLMFW23058-KD

**MFW 23118**  
FLMFW23118-KA-217  
FLMFW23118-KA-221  
FLMFW23118-KA-224  
FLMFW23118-KA-237  
FLMFW23118-KA-238  
FLMFW23118-KD

23000 Series Cam Locks DISC TUMBLER Single Bitted		
MODEL NO.	DESCRIPTION	TUMBLER MECHANISM
MFW 23038	3/8" 'A' Dimension	
MFW 23058	3/8" 'A' Dimension	
MFW 23078	3/8" 'A' Dimension	
MFW 23118	1 1/8" 'A' Dimension	
MFW 23138	1 3/8" 'A' Dimension	

### Dust Shutter Cam Locks

These locks feature FlexaCam™ that ensure a proper fit. 3 spacers of 3 thicknesses. Dust shutter passed 20,000 cycle test. Corrosion resistant stainless steel cap, designed to withstand 200 hours of salt spray test.

FLMFWDS23058-KD  
FLMFWDS23058-217  
FLMFWDS23058-221  
FLMFWDS23058-224  
FLMFWDS23078-KD  
FLMFWDS23078-217  
FLMFWDS23078-221  
FLMFWDS23078-224

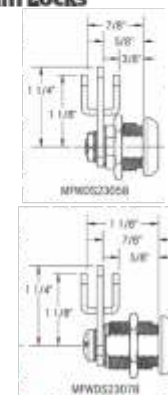



## METAL DRAWER LOCKS

### Single Bitted Drawer & Showcase Locks with Universal Keyway 23000 Series Locks

**MULTI-FUNCTION**

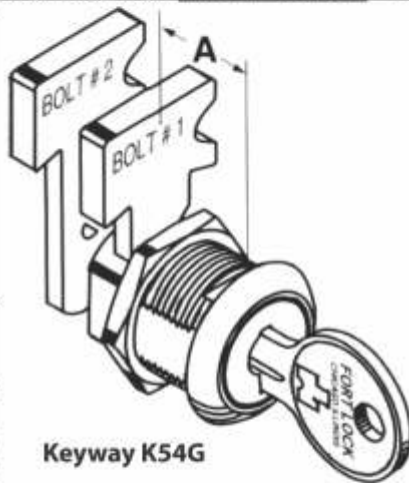

Keyway K54G

- MFW 23010
- FLMFW23010-KA-217
- FLMFW23010-KA-221
- FLMFW23010-KA-237
- FLMFW23010-KA-238
- FLMFW23010-KD
- FLK54G KEY BLANK

Metal Drawer Lock Stainless Steel Finish	
MODEL NO.	DESCRIPTION
MFW23010	-2 Bolt Throw Heights
	-Bolt Notched for Assembled Installation
	-90° Key Turn to Open
	-Key Removable Locked or Unlocked
	-Removable Cylinder for Rekeying
	-'A' Dimension 2 3/8"

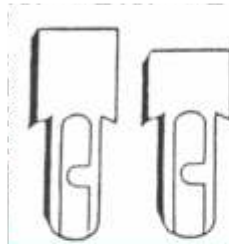

Two sizes of lockbolts included

#### WHAT MULTIFUNCTION IS:

With this one lock, you can easily make an assembly that will meet your own particular requirements.

**Cam Stops** **Cam Fillers**

90° 180°  
For either right or left hand application (by reversing)

"A" Position  
"B" Position

Flats are vertical with the GEM type tubular locks with the key entry positions as shown above.

**Retaining Pin Up Position**

"A" Position  
Normally used parallel to cam sides.

**Retaining Pin Down Position**

"B" Position  
For additional cam rotations with key entry at 12 o'clock. Use cam filler perpendicular to cam sides.

**Example**  
Key rotation 12 to 3  
Cam rotation 3 to 6

#### ROUND HOLE INSTALLATION WITH THE WONDER WASHER:

After drilling 3/4" hole in either wood or metal, position the Wonder Washer (tabs inward and vertical) firmly into hole from either the front or rear surface, depending on thickness of material and preference. The Wonder Washer provides the double rotating when installed.

## CYLINDERS

### Vending Machine Locks High Security Tubular Key Locks GEM 1000 Series Locks - 7 Pin Tumbler

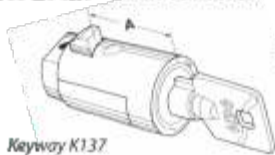

Keyway K137

When key combination change is desired, the cylinder is easily replaced with a new cylinder by simply depressing the latch bolt of the existing cylinder and withdrawing it from the handle.

- YPT 1010**  
 FLYPT1010-KA-27379  
 FLYPT1010-KA-27381  
 FLYPT1010-KD

### Inner Cylinder - Nickel FinishKD, KA27379

MODEL NO.	DESCRIPTION
YPT1010	-Inner Cylinder for POP-OUT Handles
	-Meets NAMA Standards
	-'A' Dimension, 59/64"

## ACCESSORIES

**AW1** **AW3** **CA-1**

FLAW1 Washer, Anchor, Wood  
 FLAW3 Washer, Anchor, Metal  
 FLCA-1 Cam Adapter

**SF** **201**

FLSF2400 A = 1-1/2"  
 FLSF2800 A = 1-3/4"  
 FLSF3200 A = 2"  
 FLSF4000 A = 2-1/2"  
 FL201 Cam-Flat Hook

**RKK**

**Rekey Kit**  
 FLRKK110 1000 Series  
 FLRKK130 23000/24000 Series

- Key Blanks**
- FLK60 KEY BLANK 7000 SERIES
  - FLK750 KEY BLANK 5000 SERIES
  - FLK752 KEY BLANK 8000 SERIES
  - FLK757 KEY BLANK 5000 SERIES
  - FLK775 KEY BLANK 9000 SERIES
  - FLK84 KEY BLANK 16000 SERIES
  - FLK54G KEY BLANK 23000 SERIES
  - FLKL54G KEY BLANK 23000 SERIES
  - FLKS54G KEY BLANK 4-DISC
  - FLKS900 KEY BLANK SG9000 SERIES
  - FLK137 KEY BLANK 1000 SERIES



## THUMB TURN CAM

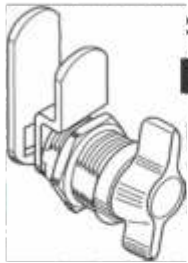

Standard Thumb Turn Cam Lock provided with our Multi-Function Packaging

**MULTI-FUNCTION**

### Threaded Shaft Lock Nickel Finish

MODEL NO.	DIMENSION
FLMFWTT058	5/8" 'A' Dimension
FLMFWTT078	7/8" 'A' Dimension

FLMFWTT058  
FLMFWTT078

## SHOWCASE LOCKS

Double Bitted High Security Locks 29000 Series - 5 Tumbler Locks

**MULTI-FUNCTION**

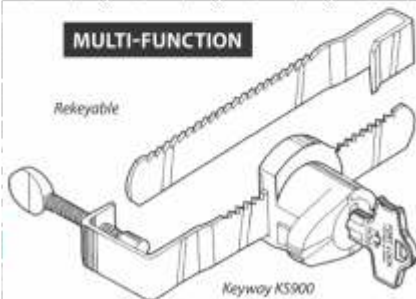

Rekeyable

Keyway KS900

### Wood/Glass Showcase Lock Nickel Plated

MODEL NO.	DESCRIPTION
MFWSG 29000	-2 One-Way Bars, Wood & Glass
	-Removable cylinder for Rekeying
	-Anti-Spread Housing

**MFWSG 29000**  
FLMFWSG29000-KA-3012  
FLMFWSG29000-KA-3045  
FLMFWSG29000-KA-3059  
FLMFWSG29000-KD

## SLIDING DOOR LOCKS

Single Bitted Door Locks with Universal Keyway

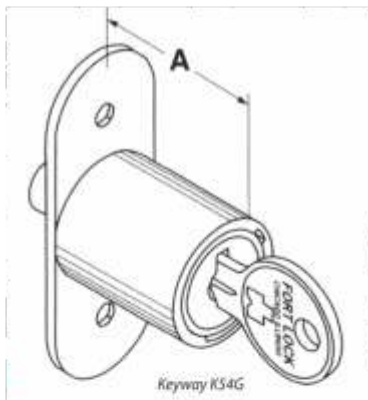

Keyway KS4G

### Sliding Door Lock Nickel Finish

MODEL NO.	DESCRIPTION
SD 990	• Plunger Action, Wood Door Lock
	• 'A' Dimension, 1 1/2"
	• 1/2" Bolt Throw
	• Key Pull at 12:00 only in unlocked position (3:00)
	• Turn key back to 12:00 to remove key, then push plug in to lock

**SD 990**  
FLSD990-KA-217  
FLSD990-KA-221  
FLSD990-KA-224  
FLSD990-KA-237  
FLSD990-KD

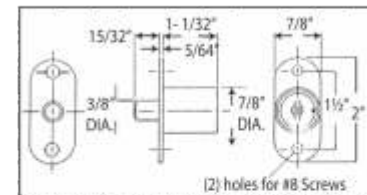

## THREADED SHAFT LOCK

High Security Tubular Key Locks GEM 1000 Series Locks - 7 Pin Tumbler

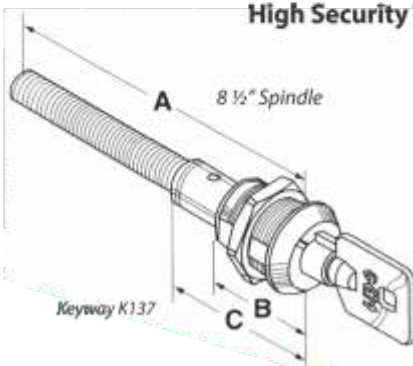

A 8 1/2" Spindle

Keyway K137

### Threaded Shaft Lock Nickel Finish

MODEL NO.	DESCRIPTION
TS 1058U	• 'A' Dimension, 8"
	• 'B' Dimension, 3/8"
	• 'C' Dimension, 1 1/2"
	• 4 Key Pulls at 12, 3, 6 and 9 o'clock

This lock serves two purposes - that of drawing in a door (or cover tightly), and locking it. The spindle is securely attached to the lock.

**Specifications**  
Spindle - Steel, zinc plated, 5/8" x 18 threads standard.

**TS 1058U**  
FLTS1058U-KA-27379  
FLK137 Keyblank

## SWITCH LOCKS

### High Security Tubular Key Locks GEM 1000 Series Locks - 7 Pin Tumbler

The Fort multi-function switch lock includes all necessary parts to field change the unit for one key pull or momentary contact operation. The UL approved switch contains terminals to provide optional normally open or normally closed electrical operation. A wiring diagram and color coded wires are included to simplify the electrical installation.

Rekeying to existing key systems can be readily done. A drilled and tapped retainer pin is used. Continued turning of a 4-40 threaded screw, into the retaining pin, will drive the pin out for changing.

#### 3-wire switch assembled to lock may be adapted as follows:

- When all 3 wires are used - switch is single pole double throw.
- When 2 wires are used - switch is a single pole single throw - normally open or closed.
- The 3-10" lead wires & connectors may be cut to size.
- Switch is UL & CSA listed - rated for 7 AMPS 28 VDC 250 VAC.
- Finish - Polished nickel.
- Switches - Single Pole, Single Throw. 110-120V, AC, 7 amps

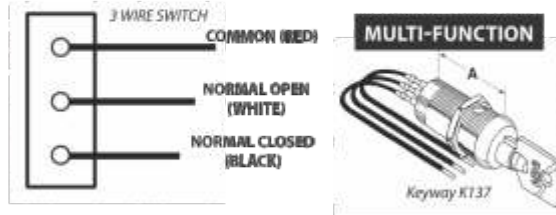

### Switch Lock - Momentary & Maintaining - Nickel

MODEL NO.	DESCRIPTION
<b>MFSW3-1138</b>	• Rekeyable Switch Lock - UL Rated
FLMFSW3-1138-KA-27379	• Maintaining & Momentary Contact, Single Pole, Double Throw Switch, 125/250VAC
FLMFSW3-1138-KA-27380	
FLMFSW3-1138-KA-27381	• 7A (Resistive Load)
FLMFSW3-1138-KA-27382	
FLMFSW3-1138-KD	• Lead Length 10"
	• 'A' Dimension 1 3/8"

#### SW2-3118AD and SW20-3118MC Specifications:

- 23000 Series Keyway
- Single Bitted - 5 or 6 Disc Tumblers
- 7 Amps - 110VAC (Resistive Load)

Switch Lock - Momentary Nickel Finish	
MODEL NO.	DESCRIPTION
<b>SW20-1138MC</b>	• Momentary Contact, Single Pole, Single Throw Switch
FLSW20-1138MC-KA-27379	• 110-120VAC, 7 Amps (Resistive Load)
FLSW20-1138MC-KD	
	• Operation: 90° CW Turn Contacts Closed-Spring Back to 12:00, Key Removable
	• 'A' Dimension, 1-3/8"
	• Lead Length 10"

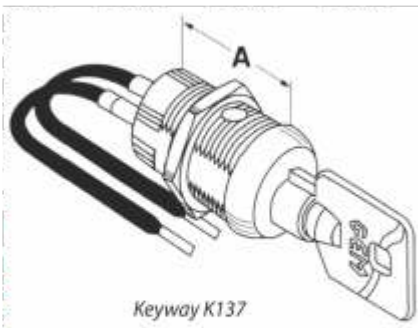

Switch Lock - Maintaining Nickel Finish	
MODEL NO.	DESCRIPTION
<b>SW2-3118AD</b>	• 23000 Series Keyway
FLSW2-3118AD-KA-217	• 'A' Dimension, 1 3/8"
FLSW2-3118AD-KD	
	• Lead Length 10"
	• 2 Key Pulls at 12:00 & 3:00
	• Maintains Contact at 3:00, Open at 12:00
	• 7 Amps - 110VAC (Resistive Load)

Switch Lock - Momentary Nickel Finish	
MODEL NO.	DESCRIPTION
FLSW20-3118MC-KA-217	• 23000 Series Keyway
FLSW20-3118MC-KD	
<b>SW20-3118MC</b>	• 'A' Dimension, 1 3/8"
	• Lead Length 10"
	• 1 Key Pull at 12:00 Only
	• Momentary Contact at 3:00, springs back to 12:00
	• 7 Amps - 110VAC (Resistive Load)



SW2-3118AD = (Off and On)  
SW20-3118MC = (Momentary)

## REGULATOR



PART NUMBER	DESCRIPTION
FLREG-M-L-3	REGULATOR MANUAL LH 1-3/16"
FLREG-M-L-5	REGULATOR MANUAL LH 1-3/4"
FLREG-M-R-3	REGULATOR MANUAL RH 1-3/16"
FLREG-M-R-5	REGULATOR MANUAL RH 1-3/4"
FLREG-M-V-3	REGULATOR MANUAL VERT MOUNT 1-3/16"
FLREG-M-V-5	REGULATOR MANUAL VERT MOUNT 1-3/4"
FLREG-S-L-3	REGULATOR SLAMCAM LH 1-3/16"
FLREG-S-L-5	REGULATOR SLAMCAM LH 1-3/4"
FLREG-S-R-1	REGULATOR SLAMCAM RH 7/16"
FLREG-S-R-3	REGULATOR SLAMCAM RH 1-3/16"
FLREG-S-R-5	REGULATOR SLAMCAM RH 1-3/4"
FLREG-S-V-1	REGULATOR SLAMCAM VERT MOUNT 7/16"
FLREG-S-V-3	REGULATOR SLAMCAM VERT MOUNT 1-3/16"
FLREG-S-V-5	REGULATOR SLAMCAM VERT MOUNT 1-3/4"



**CAM LOCKS**

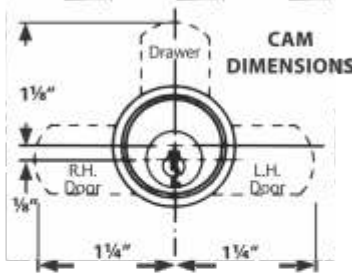

Through the use of a shifter, the 360° key turn turns the cam 90° in either direction. Actual application determines which cam position is the locked position. Each lock is furnished with an alternate cam for opposite cam turn.

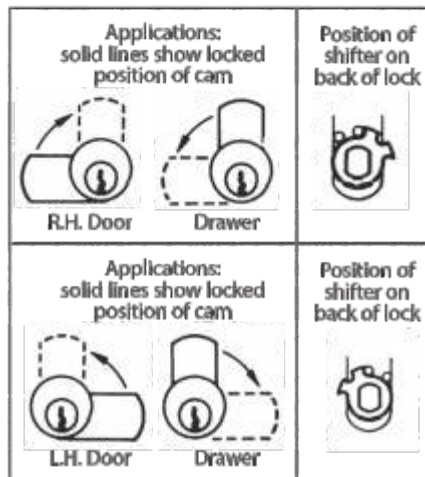

- FINISHES:**  
 03 Bright Brass  
 4G Antique Brass  
 14A Bright Nickel  
 26 Bright Chrome  
 26D Dull Chrome

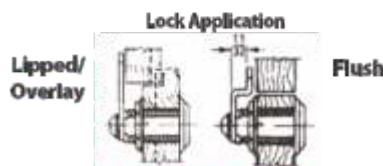
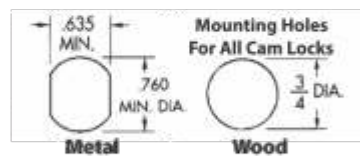

**APPLICATION** - For drawer, R.H. or L.H. doors. C8103 are for lipped or overlay construction. For overlay application, the combined thickness of front and frame cannot exceed the cylinder length. Also see overlay detail below. The other locks are for flush application.

**OPERATION** - 90° cam turn, key removable in both locked and unlocked positions.

**KEYING** - Will key together with all other pin tumbler locks using D4291 key blank.

**PACKAGING** - Supplied with two keys, trim washer, spur washer for wood, mounting nut and two cams.

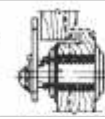

Lipped/Overlay



Pin Tumbler Cylinder Cam Lock				
Part No.	Type of Mounting	Cylinder Length	Max. Material Thickness	Case Quantity
NLC8101-107-26D	Lipped/ Overlay	1 5/8"	3/8"	10
NLC8103-103-26D	Lipped/ Overlay	1 3/8"	3/8"	10

The C8102 is a Multi-Functional Pin Tumbler Cam Lock with a 1-1/16" Cylinder Length. The lock is packaged with four (4) cams, two straight and two double formed. This allows the lock to be used for multiple applications for either door or right hand/left hand doors with lipped or overlay construction.

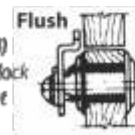

Pin Tumbler Cylinder Cam Lock				
Part No.	Type of Mounting	Cylinder Length	Max. Material Thickness	Case Quantity
NLC8102-107-26D	Flush	1 3/8"	3/8"	10

**Disc Tumbler Cylinder Cam Locks**

**APPLICATION** For drawers, R.H. or L.H. doors with lipped/overlay construction (straight cam) or flush construction (formed cam). For overlay application, the combined thickness of front and frame cannot exceed the cylinder length.

**OPERATION** - 90° cam turn on all locks. Key removable in both locked and unlocked positions.

**KEYING** - Will key together with all other disc tumbler locks using D8785 key blank.

**PACKAGING** - Supplied with two keys, trim washer, spur washer (for wood), mounting nut and two cams. If flat washer (for metal) is needed, order C2015-2C separately.

Disc Tumbler Cylinder Cam Locks				
Part No.	Type of Mounting	Cyl. Length	Max. Material Thickness	Case Qty.
C8051	Lipped/Overlay or Flush	7/8"	7/64"	25
C8052		5/8"	1/16"	25
C8054		7/16"	3/8"	25

**C8051**

- NLC8051-C346A-14A 7/16" Cyl/Disc
- NLC8051-C413A-14A 7/16" Cyl/Disc
- NLC8051-C415A-14A 7/16" Cyl/Disc
- NLC8051-KD-14A 7/16" Cyl/Disc

**C8052**

- NLC8052-C346A-14A 5/8" Cyl/Disc
- NLC8052-C390A-14A 5/8" Cyl/Disc
- NLC8052-C413A-14A 5/8" Cyl/Disc
- NLC8052-C415A-14A 5/8" Cyl/Disc
- NLC8052-C415A-3 5/8" Cyl/Disc
- NLC8052-C420A-14A 5/8" Cyl/Disc
- NLD8785 Keyblank

- NLC8052-C642A-14A 5/8" Cyl/Disc
- NLC8052-KD-14A 5/8" Cyl/Disc

**C8054**

- NLC8054-C346A-14A 5/8" Cyl/Disc
- NLC8054-C346A-4G 5/8" Cyl/Disc
- NLC8054-C390A-14A 5/8" Cyl/Disc
- NLC8054-C413A-14A 5/8" Cyl/Disc
- NLC8054-C415A-14A 5/8" Cyl/Disc
- NLC8054-C415A-3 5/8" Cyl/Disc
- NLC8054-C420A-14A 5/8" Cyl/Disc
- NLC8054-C642A-14A 5/8" Cyl/Disc
- NLC8054-KD-14A -



**CAM LOCKS — continued**

**Disc Tumbler Cylinder Cam Locks**

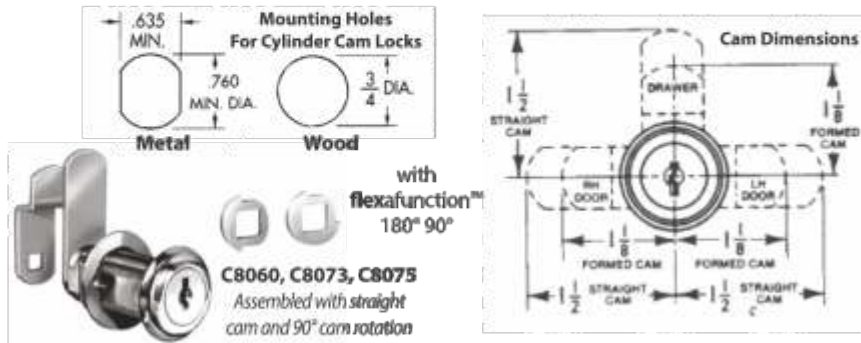

**C8060, C8073, C8075**  
Assembled with straight cam and 90° cam rotation

**C8060**

- NLC8060-C346A-14A 1 3/4" Cyl/Disc
- NLC8060-C346A-4G 1 3/4" Cyl/Disc
- NLC8060-C413A-14A 1 3/4" Cyl/Disc
- NLC8060-C415A-3 1 3/4" Cyl/Disc
- NLC8060-KD-14A 1 3/4" Cyl/Disc

**C8073**

- NLC8073-C346A-14A 1 3/16" Cyl/Disc
- NLC8073-C346A-4G 1 3/16" Cyl/Disc
- NLC8073-C390A-14A 1 3/16" Cyl/Disc
- NLC8073-C413A-14A 1 3/16" Cyl/Disc
- NLC8073-C415A-14A 1 3/16" Cyl/Disc
- NLC8073-C415A-3 1 3/16" Cyl/Disc
- NLC8073-C420A-14A 1 3/16" Cyl/Disc
- NLC8073-C642A-14A 1 3/16" Cyl/Disc
- NLC8073-KD-14A 1 3/16" Cyl/Disc
- NLC8073-MKKD-14A 1 3/16" Cyl/Disc

**C8075**

- NLC8075-C346A-14A 1 3/16" Cyl/Disc
- NLC8075-C346A-4G 1 3/16" Cyl/Disc
- NLC8075-C390A-14A 1 3/16" Cyl/Disc
- NLC8075-C413A-14A 1 3/16" Cyl/Disc
- NLC8075-C415A-14A 1 3/16" Cyl/Disc
- NLC8075-C415A-3 1 3/16" Cyl/Disc
- NLC8075-C420A-14A 1 3/16" Cyl/Disc
- NLC8075-C642A-14A 1 3/16" Cyl/Disc
- NLC8075-KD-14A 1 3/16" Cyl/Disc
- NLD8783 Keyblank

**Disc Tumbler Cylinder Cam Locks**

Part No.	Type of Mounting	Cyl. Length	Max. Material Thickness	Case Qty.
<b>C8060</b>	Lipped/ Overlay or Flush	1 3/4"	1 3/16"	25
<b>C8073</b>		1 3/16"	7/8"	25
<b>C8075</b>	Flush	1 3/16"	1 1/8"	25

**APPLICATION** For drawers, R.H. or L.H. doors with lipped/overlay construction (straight cam) or flush construction (formed cam). For overlay application, the combined thickness of front and frame cannot exceed the cylinder length.

**OPERATION** - Choice of either 90° or 180° cam turn. Key removable in both locked and unlocked positions.

**KEYING** - Will key together with all other disc tumbler locks using D8785 key blank. **PACKAGING** - Supplied with two keys, trim washer, spur washer (for wood), mounting nut, two cams and two stop washers.

**DOOR & DRAWER LOCKS**

**Pin Tumbler Door & Drawer Locks**

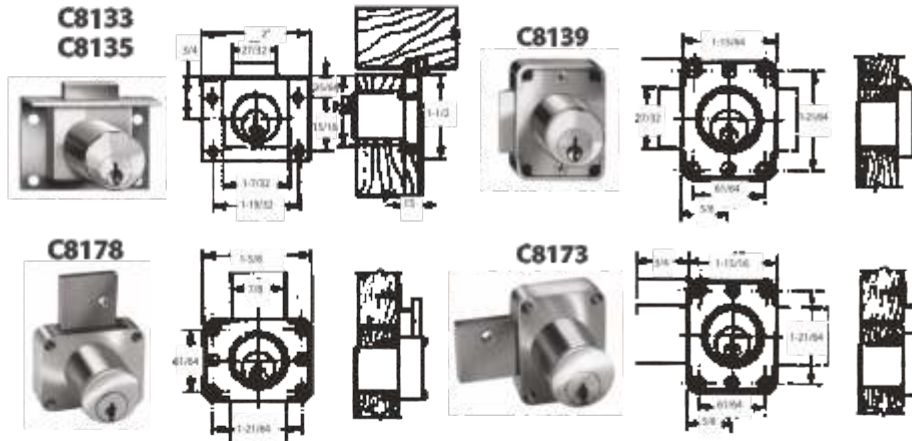

Additional mortise

**C8133 / C8135 / C8139**

**APPLICATION** - For drawers. Half mortise type requires mortise for housing and 3/8" diameter hole for cylinder.

**OPERATION** - Key removable in both locked and unlocked positions except C8131.

**KEYING** - Will key together with all other pin tumbler locks using D4291 key blank.

**PACKAGING** - Supplied with two keys, strike and mounting screw.

**C8173 / C8178**

**APPLICATION** - For drawers, R.H. or L.H. doors. Surface mounted. Requires 1" dia. hole for cylinder.

**OPERATION** - Key removable in both locked and unlocked positions except C8139.

**KEYING** - Will key together with all other pin tumbler locks using D4291 key blank.

**PACKAGING** - Supplied with two keys, strike and mounting screw.

**MOUNTING HOLE** - required for mounting.

**Pin Tumbler Door & Drawer Locks**

Part No.	Installation	Bolt Type	Cylinder Length	Bolt Travel	Case Qty.
NLC8133-103-26D	Drawer	Dead	3/8"	3/4"	10
NLC8135-KD-26D	Drawer	Dead	1 1/8"	3/4"	10
NLC8139-103-26D	Door	Spring	3/4"	7/32"	10
NLC8173-103-26D	Door	Dead	3/8"	3/4"	10
NLC8178-103-26D	Drawer	Dead	3/8"	3/4"	10

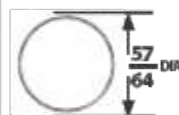

- Finishes:**
- 03 Bright Brass
  - 4G Antique Brass
  - 14A Bright Nickel
  - 26 Bright Chrome
  - 26D Dull Chrome

**"THE ADVANTAGE PLUS"**

The PLUS feature allows you to remove the cylinder from the pin tumbler box locks while the lock remains in place. No mounting screws need to be removed. Simply use a 5/64" allen wrench from the back to remove the cylinder and plug for re-keying.

MAILBOX LOCKS



C9200

C9100 and C9200 Features:

- Stainless Steel plug
- 12" taper on cylinder head
- Now able to accommodate up to 3/8" cam
- Drain holes on the bottom of the cylinder
- Will include spring clip, mounting nut, and (3) keys
- How the lock opens determines key rotation

NL C9100 Clockwise  
NL C9200 Counter Clockwise

Pin Tumbler "Multi-Cam"™ Mail Box Locks

C8730 - "MULTI-PURPOSE"

**APPLICATION** – Interior architectural mail boxes used in apartments, condominiums, schools, lobbies. Nut or clip mounted.  
**OPERATION** – 90° counter-clockwise cam turn to open. Key removable in locked position only.  
**KEYING** – Available keyed differently only (100 changes).  
**PACKAGING** – Supplied with selection of five cams, two keys, mounting nut, mounting clip and cam screw.

C8735

**APPLICATION** – Exterior pedestal-mounted neighborhood boxes. Has keyway dust shutter for lock protection. Clip mounted.  
**OPERATION** – 90° clockwise cam turn to open. Key removable in locked position.  
**KEYING** – Available keyed differently only (100 changes).  
**PACKAGING** – Supplied with a selection of five cams, three keys, mounting clip, cam locking nut.

THIS LOCK MEETS U.S.P.S. SPECIFICATION #L-1172 AND DRAWING #1003833 FOR NDCBU AND CBU APPLICATIONS.

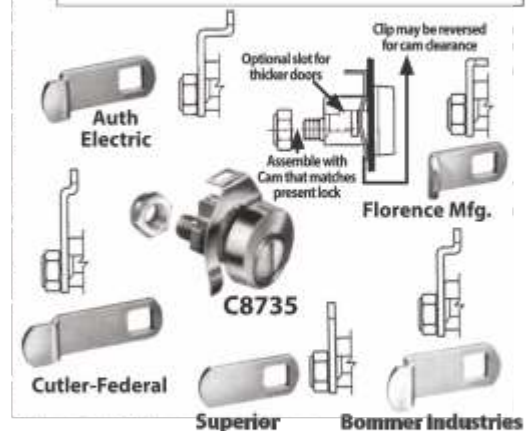

Pin Tumbler "Multi-Cam"™ Mail Box Locks

Part No.	Installation	Direction of Turn to Open
NLC8730	Architectural Mail Box Fronts	90° c/cw
NLC8735	Door Of Pedestal Mounted Neighborhood Boxes	90° cw

Pin Tumbler Mail Box Locks



Part No.	Locked Cam Position	Direction of Turn to Open	Replaces
NLC8710	Left	90° c/cw	Bommer Industries
NLC8711	Up	90° c/cw	Bommer Industries
NLC8712□	Down	90° c/cw	Bommer Industries
NLC8713	Left	90° c/cw	Auth Electric-Also Bommer Industries
NLC8714	Left	90° c/cw	American Device
NLC8715	Up	90° c/cw	Florence Mfg.
NLC8716	Up	90° c/cw	S.H. Couch
NLC8717	Left	90° c/cw	Nutone
NLC8718	Left	90° c/cw	Cutler Mail Chute
NLC8719	Up	90° c/cw	Miami-Carey
NLC8720□	Down	90° c/cw	Dura Steel
NLC8721	Left	90° c/cw	Permabit-XL-201
NLC8722	Down	90° c/cw	Dura Steel-XL-202
NLC8723	Left	90° c/cw	Jensen General
NLC8724	Left	90° c/cw	Bommer Industries
NLC8725	Left	90° c/cw	Cutler Federal
NLC8726	Right	90° cw	Riopel - Canada
NLC9300	and C8720 are provided with a		



MOUNTING HOLE FOR ALL LOCKS

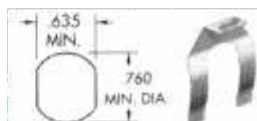

SPRING MOUNTING CLIP

**APPLICATION** – For doors on architectural mail boxes serviced by United States Postal Service.  
**OPERATION** – 90° cam turn.  
**KEYING** – Available keyed differently only (100 changes).  
**PACKAGING** – Supplied with two keys and a spring mounting clip. C8720 furnished with trim ring.



SLIDING DOOR LOCKS

Pin Tumbler Sliding Door, File Cabinet Locks



C8142



C8140

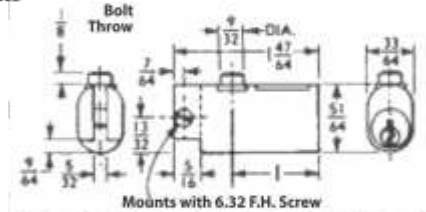
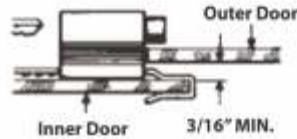

C8150

C8140 / C8142 / C8150

**APPLICATION** – C8140 is for sliding glass doors. C8142 and C8143 are for wood sliding doors and require a 7/8" dia. hole in front door for cylinder. C8150 is used internally on filing cabinets to gang lock drawers.

**OPERATION** – C8140 and C8150: key removable in locked position only. C8142: key removable in both locked and unlocked positions.

**KEYING** – Will key together with all other pin tumbler locks using D4291 key blank.

**PACKAGING** – Supplied with two keys. C8142 furnished with strike and mounting screws.

**Finishes:**

- 03 Bright Brass
- 4G Antique Brass
- 14A Bright Nickel
- 26 Bright Chrome
- 26D Dull Chrome

Pin Tumbler Door & Drawer Locks

Part No.	Installation	Bolt Type	Cylinder Length	Bolt Travel	Case Qty.
NLC8140-KD-26D	Plate Glass Sliding Doors	Internal Spring	—	—	10
NLC8140-107-26D					
NLC8142-KD-26D	Sliding Door	Plunger	1 3/8"	7/16"	10
NLC8142-101-26D					
NLC8142-915-26D					
NLC8150-KD-26D	Filing Cabinet	Spring	—	1/8"	10
NLC8150-103-26D					

Disc Tumbler Sliding Door Locks

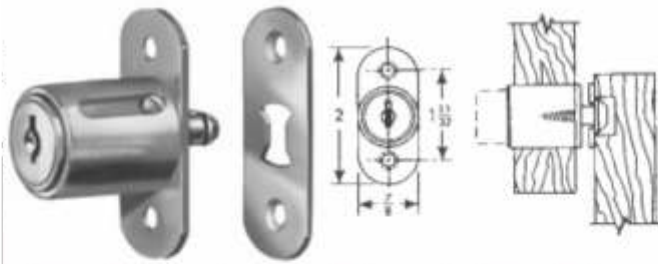

MOUNTING HOLE



C8042

**APPLICATION** – For wood sliding doors. Requires a 7/8" dia. hole in front door for cylinder.

**OPERATION** – C8042: push in cylinder, key turn engages bolt behind strike. Key removable in both locked and unlocked positions.

**KEYING** – Will key together with all other disc tumbler locks using D8785 key blank.

**PACKAGING** – Supplied with two keys, strike and mounting screws.

Disc Tumbler Sliding Door Locks

Part No.	Installation	Bolt Type	Cylinder Length	Bolt Travel	Case Qty.
NLC8042-C413A-26D	Sliding Doors	90° Turn Hook	3/8"	7/16"	10
NLC8042-C415A-26D					



**DRAWER LOCKS**

**Disc Tumbler Door & Drawer Locks**



**C8701**

**APPLICATION** – C8701: for center drawers of metal desks. Fits special piercing of drawer front and seldge (see drawing).

**OPERATION** – Key removable in both locked and unlocked positions.

**KEYING** – C8701 will key together with all other disc tumbler locks using D8785 key blank.

**PACKAGING** – Supplied with two keys. C8701 furnished with mounting nut. Case qty (25).

Part No.	Installation	Bolt Type	Cylinder Length	Bolt Travel
NLC8701-KD-14A	Metal Drawer, 1/4" Max Mat'l Thickness	Reinforced Insertable Dead Bolt	1 1/2"	1 1/2"

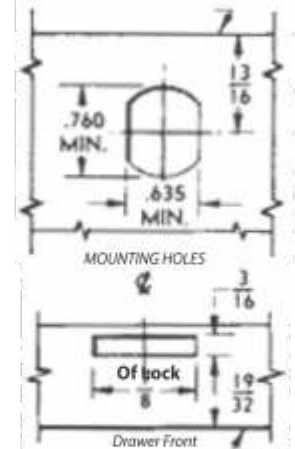

**C8803 / C8704**

**APPLICATION** – For drawers and doors. Surface mounted. Requires 7/8" dia. hole for cylinder.

**OPERATION** – Key removable in both locked and unlocked positions.

**KEYING** – Will key together with all other disc tumbler locks using D8785 key blank.

**PACKAGING** – Supplied with two keys and mounting screws.

**C8704**

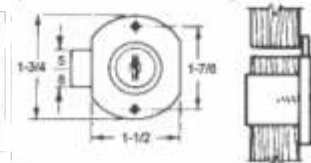

Part No.	Installation	Bolt Type	Cylinder Length	Bolt Travel
NLC8704-C415A-3	Door	Dead	1 1/4"	1 1/2"

**C8803**

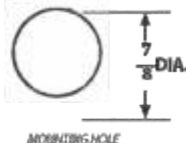
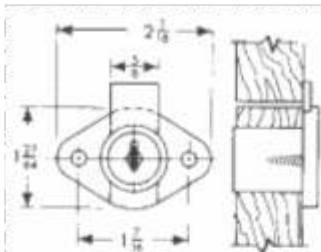

Part No.	Installation	Bolt Type	Cylinder Length	Bolt Travel
NLC8803-C346A-3	Drawer	Dead	1 1/4"	1 1/2"
NLC8803-C413A-3	Drawer	Dead	1 1/4"	1 1/2"
NLC8803-C415A-14A	Drawer	Dead	1 1/4"	1 1/2"
NLC8803-C415A-3	Drawer	Dead	1 1/4"	1 1/2"
NLC8803-C420A-3	Drawer	Dead	1 1/4"	1 1/2"
NLC8803-KD-3	Drawer	Dead	1 1/4"	1 1/2"

**Pin Tumbler Drawer Locks**

**C8163**

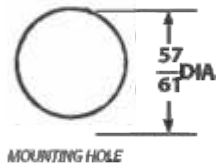
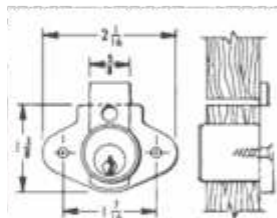

**C8163 locks feature easy removal of cylinder from lock housing while lock remains in place. Bolt has access hole for cylinder retention screw at back of lock. U.S. Patent No. 4,899,563.**

**APPLICATION** – For drawers. Surface mounted. Requires 57/64" dia. hole for cylinder.

**OPERATION** – Key removable in both locked and unlocked positions.

**KEYING** – Will key together with all other pin tumbler locks using D4291 key blank.

**PACKAGING** – Supplied with two keys, strike and mounting screws.

Part No.	Installation	Bolt Type	Cylinder Length	Bolt Travel
NLC8163-KD-4	Drawer	Dead	1 1/4"	1 1/2"
NLC8163-101-4	Drawer	Dead	1 1/4"	1 1/2"
NLC7163-2C	Bolt-Extended For C8163 3" Long			

**C7163-2C**



Extended bolt for C8163 drawer lock provides 3" extension, can be cut to required length. Packed 20 pcs. per bag.





**FURNITURE LOCKS**

**Furniture Locks**

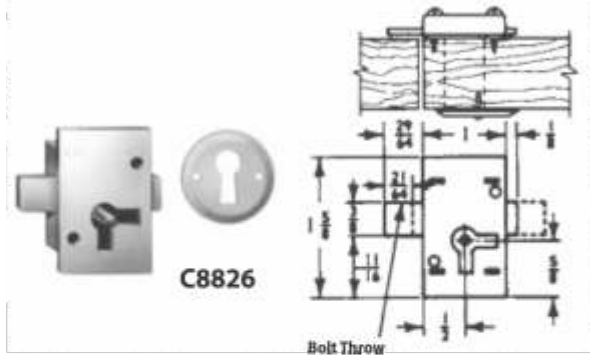
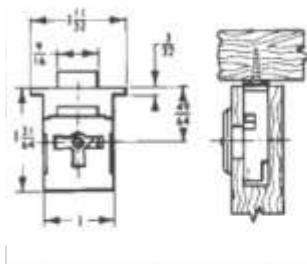

**C8207 / C8826**

**APPLICATION** – This group of locks is used primarily on furniture and other fine cabinetry. C8826 is surface mounted and requires hole for key entry, all other locks require full 1 1/32" x depth of lock. Additional mortising, required for lock selvedge plus hole for key entry.

**OPERATION** – Key removable in both locked and unlocked positions.

**KEYING** – Each lock furnished keyed alike. D8890 key blank.

**PACKAGING** – Supplied with one key. All locks except C8826 are supplied with strikes. Key hole escutcheons are packed with C8207 & C8826.

Furniture Locks				
Part No.	Installation	Bolt Type	Bolt Travel	Case Qty.
NLC8207-KA-3	R.H. Door, Drawer, Full Mortise	Dead	3/16"	25
NLC8826-KA-3	Door/Drawer, Surface Mounted	Dead	2/64"	25

**FILE CABINET LOCKS**

**Disc Tumbler File Cabinet Locks**

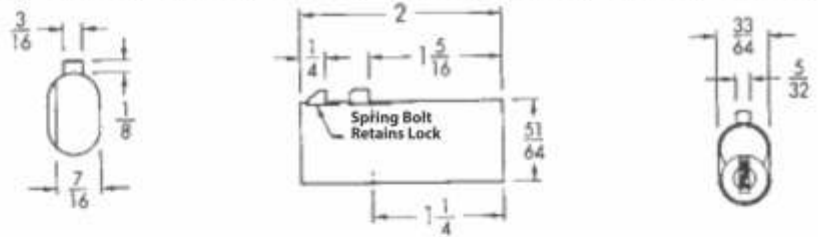

Replacement For "SHAW WALKER"

**C8047**

**APPLICATION** – Used internally on filing cabinets to gang lock drawers.

**OPERATION** – Key removable in locked position only.

**KEYING** – Keyed only to "Pundra" keyway. D8776 key blank.

**PACKAGING** – Supplied with two keys.

Disc Tumbler File Cabinet Locks				
Part No.	Installation	Bolt Type	Bolt Travel	Case Qty.
NLC8047-KD-26	Filing Cabinet	Spring	1/8"	25
NLC8047-P141A-26	Filing Cabinet	Spring	1/8"	25

**KNOB LOCKS**

**Pin Tumbler Knob Locks**

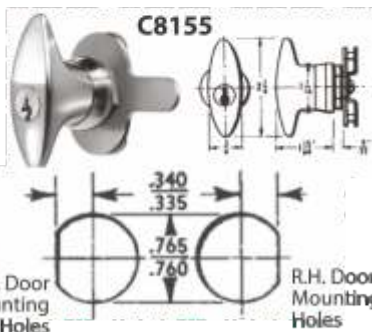

**APPLICATION** – For metal cabinets doors. Reversible for R.H. or L.H. application. Latch plate is used for either in 2[] or 3 point latching.

**OPERATION** – 90° turn to open.

**KEYING** – Will key together with all other pin tumbler locks using D4291 key blank

**PACKAGING** – Supplied with two keys, mounting nut and screw for latch plate.

Pin Tumbler Knob Locks				
Part No.	Installation	Operation of Key	Maximum Material Thickness	Case Qty.
NLC8154-KD-26D	Door	Key Removable in Both Locked & Unlocked Positions	1/8"	10
NLC8155-KD-26D	Door	Key Removable in Locked Position Only	1/8"	10





MISCELLANEOUS LOCKS

Mounting Plate



Mounting plate for cylinder cam locks, screw mounted. Used where spur washer will not embed into hard surface.

Part No.	Description	Overall Dimensions
NLC2016-2C	Mounting plate for cam locks Screw mounted, use No. 8 screws, not furnished.	2 3/8" x 1 1/4"

Disc Tumbler Cams

Selection of cams that permit adaption of disc tumbler cylinder cam locks to meet nearly every application need. Straight Hook Cams and Double Formed Cams can be reversed when required.

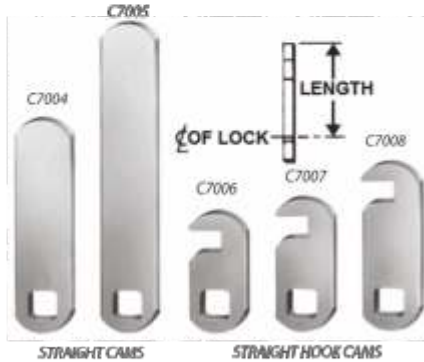

Part No.	Description	Description
NLC7004-2C	Straight Cam	2"
NLC7005-2C	Straight Cam	3"
NLC7006-2C	Straight Hook Cam	1"
NLC7007-2C	Straight Hook Cam	1 3/8"
NLC7008-2C	Straight Hook Cam	1
NLC7014-2C	Double Formed Cam	3/8" x 1 5/8"



NLV71D-3 Disc Tumbler Keying Kit

Includes: 100 Pcs. ea. 00, 22, 44 and 66 Tumblers. 250 Pcs. Tumbler Springs.



Disc Tumbler Keying Kit Replacement Parts













- NLC6782 Tumbler #00 Tan (250/PKG)
- NLC6783 Tumbler #22 Black (250/PKG)
- NLC6784 Tumbler #44 SILVER (250/PKG)
- NLC6785 Tumbler #66 COPPER (250/PKG)



NLC7017 SlamCam Kit



LOCKS

<p><b>Drawer Lock</b> TMC280CB</p>  <p><b>Application:</b> Surface mounted lock for locking drawers. Setback of 3/8" is ideal for overlay drawers. <b>Operation:</b> 180° key rotation, CCW to lock, key removable in both locked and unlocked positions. <b>Keying:</b> Order lock plug separately, see below. <b>Packaging:</b> Housing is black, toughened nylon. Cylinder is unplated. Cams are zinc plated.</p>	<p><b>All Timberline Locks</b> consist of two separate components: a Lock Plug, and a Cylinder Body. A Change Tool (DS00KY, see below) is required to remove lock plugs from the cylinder bodies.</p> 																
<p><b>Thick Panel Lock</b> TMC170CB</p>  <p><b>Application:</b> Universal type lock for either doors or drawers that can accommodate panel thickness 3/8" to 1 3/8" thick. <b>Operation:</b> 90° key rotation, CCW to lock. <b>Keying:</b> Order lock plug separately. <b>Packaging:</b> Housing supplied with straight cam and bent cam. Housings are unplated. Cams are zinc plated.</p>	<p><b>Cam Lock Kit</b> TMC165CB</p>  <ul style="list-style-type: none"> <li>• Universal type lock for either doors or drawers. Kit contains a variety of easily switched cams to accommodate most lock situations</li> <li>• 180° cam rotation, CCW to lock</li> <li>• Order lock plug separately</li> <li>• Cylinder supplied with two straight cams and two bent cams. Cylinder is unplated, Cams are zinc plated</li> </ul>																
<p><b>Door Lock</b> TMC240CB</p>  <p><b>Applications:</b> Low Profile, surface mounted lock for locking doors. Setback of 3/8" is ideal for inset doors or locking one door behind another. <b>Operation:</b> 180° key rotation, CCW to lock, key removable in both locked and unlocked positions. <b>Keying:</b> Order lock plug separately. <b>Packaging:</b> Housing is black, toughened nylon. Cylinder is unplated. Cams are zinc plated.</p>	<p><b>Door Lock</b> TMC290CB</p>  <p><b>Application:</b> Surface mounted lock for locking doors. Setback of 3/8" is ideal for overlay doors. <b>Operation:</b> 180° key rotation, CCW to lock, key removable in both locked and unlocked positions. <b>Keying:</b> Order lock plug separately. <b>Packaging:</b> Housing is black, toughened nylon. Cylinder is unplated. Cams are zinc plated.</p>																
<p><b>Double Door Lock</b> TMC250CB</p>  <p><b>Application:</b> Surface mounted lock for locking two adjacent doors. Eliminates the need for a spring catch on the door opposite the lock. Works with overlay or inset doors. <b>Operation:</b> 180° key rotation, CCW to lock, key removable in locked &amp; unlocked positions. <b>Keying:</b> Order lock plug separately. <b>Packaging:</b> Supplied with two strike plates as shown. Housing is black, toughened nylon. Cylinder is unplated. Cams are zinc plated.</p>	<p><b>Push Lock</b> TMC175CB</p>  <p><b>Application:</b> For locking sliding, bypass type doors. Requires 3/8" hole in front door for cylinder. <b>Operation:</b> Pushing in cylinder locks doors, with or without key. 45° key rotation allows cylinder to pop back out to unlock doors. Key removable in both locked and unlocked positions. <b>Keying:</b> Order lock plug separately. <b>Packaging:</b> Supplied with nickel plated finish cup as shown. Housing is black, toughened nylon.</p>																
<p><b>Side Gang Lock — 2 Drawer</b> TM D270CB</p>  <p><b>Application:</b> Two drawer gang lock for locking two pedestal drawers with a single lock. Lock mounts on side of cabinet. <b>Operation:</b> 180° key rotation, CCW to lock, key removable in both locked and unlocked positions. <b>Keying:</b> Order lock plug separately. <b>Packaging:</b> Housing supplied with two CS00DC-19 Drawer Clips. Housing is black, toughened nylon. Cylinder is unplated. Cams are zinc plated.</p>	<p><b>Drawer Lock</b> TMC230CB</p>  <p><b>Application:</b> Low Profile, surface mounted lock for locking drawers. Setback of 3/8" is ideal for inset drawers. <b>Operation:</b> 180° key rotation, CCW to lock, key removable in both locked and unlocked positions. <b>Keying:</b> Order lock plug separately. <b>Packaging:</b> Housing is black, toughened nylon. Cylinder is unplated. Cams are zinc plated.</p>																
<p><b>Side Gang Lock</b> TMD150CB</p>  <p><b>Application:</b> For locking banks of drawers in desks, credenzas and other multiple drawer applications. Lock mount on side of cabinet. <b>Operation:</b> 180° key rotation, CCW to lock, key removable in both locked and unlocked positions. <b>Keying:</b> Order lock plug separately. <b>Packaging:</b> Cylinder is unplated.</p>	<p><b>Double Door Latch Lock</b></p> <p>TMDL-200-B Right/Top-Mt; Left/Bot-Mt TMDL-200-W Right/Top-Mt; Left/Bot-Mt TMDL-300-B Left/Top-Mt; Right/Bot-Mt TMDL-300-W Left/Top-Mt; Right/Bot-Mt</p> 																
<p><b>Front Gang Lock</b> TMD100CB</p>  <p><b>Application:</b> For locking banks of drawers in desks, credenzas and other multiple drawer applications. Lock mounts on front of cabinet. <b>Operation:</b> 180° key rotation, CCW to lock, key removable in both locked and unlocked positions. <b>Keying:</b> Order lock plug separately. <b>Packaging:</b> Cylinder is unplated.</p>	<table border="1"> <thead> <tr> <th colspan="3">Part numbers</th> </tr> <tr> <th>Lock Placement</th> <th>Top Mount Kit</th> <th>Bottom Mount Kit</th> </tr> </thead> <tbody> <tr> <td rowspan="2">Lock on Right Door</td> <td>DL-200 Black Finish</td> <td>DL-300 Black Finish</td> </tr> <tr> <td>DL-200-W White Finish</td> <td>DL-300-W White Finish</td> </tr> <tr> <td rowspan="2">Lock on Left Door</td> <td>DL-300 Black Finish</td> <td>DL-200 Black Finish</td> </tr> <tr> <td>DL-300-W White Finish</td> <td>DL-200-W White Finish</td> </tr> </tbody> </table>	Part numbers			Lock Placement	Top Mount Kit	Bottom Mount Kit	Lock on Right Door	DL-200 Black Finish	DL-300 Black Finish	DL-200-W White Finish	DL-300-W White Finish	Lock on Left Door	DL-300 Black Finish	DL-200 Black Finish	DL-300-W White Finish	DL-200-W White Finish
Part numbers																	
Lock Placement	Top Mount Kit	Bottom Mount Kit															
Lock on Right Door	DL-200 Black Finish	DL-300 Black Finish															
	DL-200-W White Finish	DL-300-W White Finish															
Lock on Left Door	DL-300 Black Finish	DL-200 Black Finish															
	DL-300-W White Finish	DL-200-W White Finish															



**PLUGS & STRIKES**

**Lock Plugs**

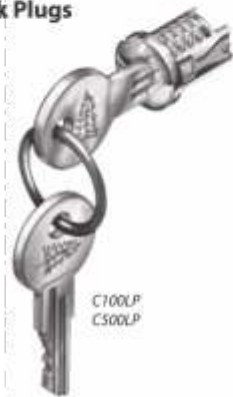

Part No.	Finish	Qty
TMC100LP-14A-KA-100T	Pol. Nickel	25
TMC100LP-14A-KA-101T	Pol. Nickel	25
TMC100LP-14A-KA-102T	Pol. Nickel	25
TMC100LP-14A-KA-103T	Pol. Nickel	25
TMC100LP-14A-KA-104T	Pol. Nickel	25
TMC100LP-14A-KA-105T	Pol. Nickel	25
TMC100LP-14A-KA-106T	Pol. Nickel	25
TMC100LP-14A-KA-107T	Pol. Nickel	25
TMC100LP-14A-KA-108T	Pol. Nickel	25

TMC100LP-14A-KA-109T	Pol. Nickel	25
TMC100LP-14A-KD	Pol. Nickel	25
TMC300LP-19-KA-100T	Black	25
TMC300LP-19-KA-104T	Black	25
TMC300LP-19-KA-105T	Black	25
TMC300LP-19-KA-108T	Black	25
TMC300LP-19-KD	Black	25
TMC500LP-3-KA-100T	Pol. Brass	25
TMC500LP-3-KA-104T	Pol. Brass	25
TMC500LP-3-KA-108T	Pol. Brass	25
TMC500LP-3-KD	Pol. Brass	25

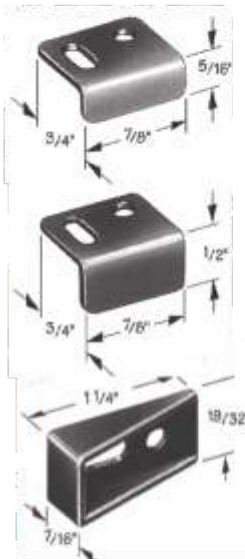

**Strike Plate 5/16" Angle**  
TMC100SP-19

**Strike Plate 1/2" Angle**  
TMC101SP-19

**Drawer Clip**  
TMC500DC-19

**Strike Plates**



**Strike Plate Slotted**  
TMC185SP-19



**Strike Plate 1/4" Offset**  
TMC257SP-19



**Cabinet Strike Plate for Stealthlock**  
TMSP-600

**CABINET LOCK**

**Stealthlock Cabinet Locking System**



- Radio frequency technology permits the Transmitter Pad to be stored anywhere – leaving no trace of visible hardware
- Allows multiple wood cabinet doors or drawers to be locked from a single transmitter pad within a 15 ft. range
- User programmable codes

TMRL-110 Receiver Kit  
TMSL-100 Retail Kit  
TMRL-AP1 Power Supply

**ACCESSORIES**



**Timberline Key Blank**  
TMD300KY

**Change Tool**

Required to remove lock plugs from cylinder bodies

TMD500KY



**BEZELS**  
TMC100BZ-14A  
TMC300BZ-19  
TMC500BZ-3

Black  
Polished Brass



# Smooth Operation

## **ML2000 Series Mortise Lockset**

This ANSI/BHMA Grade 1 mortise lock is designed to withstand the most abusive environments. Heavy-gauge steel construction with unique, patented features and a full range of functions and trim, adds to its versatility and reliability to complement any application.

Visit [www.corbinrusswin.com](http://www.corbinrusswin.com) for more information.





**CL 3300 SERIES**

**Extra Heavy-Duty Cylindrical Lever Locksets**



**Features:**

- Less cylinders
- 1 3/4" - 2" Door thickness
- 2 3/4" standard backset
- Steel, zinc dichromated for corrosion resistance
- Complies with codes
- requiring lever to return
- to within 1/2" (13mm) of door face
- Patented lever release design makes it a free wheeling lever in locked position



**Passage / Closet**  
RWCL3310-NZD-626



**Privacy / Bedroom / Bath**  
RWCL3320-NZD-626



**Entrance / Office**  
RWCL3351-NZD-626-LC



**Classroom**  
RWCL3355-NZD-626-LC



**Storeroom / Closet**  
RWCL3357-NZD-626-LC

**Mortise Locksets**



**Features:**

- Less cylinder
- Can be re-handed without disassembling the lock case
- 1 3/4" Door thickness
- 2 3/4" backset
- 5 3/4" x 4" x 3/16" Lock Case
- Heavy-gauge steel, 8" x 1 1/4" x 3/16" front
- Accommodates flat doors and doors beveled 1/4" in 2"
- Furnished 1 1/8" wide for 1 3/4" doors
- 2-piece mechanical latchbolt with anti-friction insert, 5/8" x 1" x 3/4" throw
- 3/16" effective throw and 3/8" effective auxiliary latch deadlocking latchbolt

LL = Lock Case Only for Levers

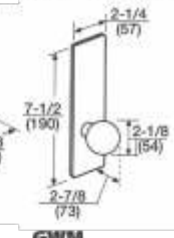
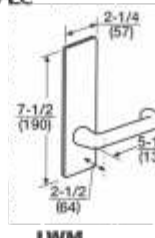
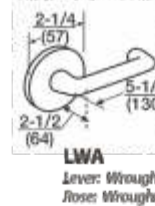

**CYLINDERS / PLUGS**

**1000 Mortise Cylinders**

For use with all mortise locks and DL3000 Deadlocks



**1 1/2" with Adams Rite Cam**

- RW1000-118-6-D1-613
- RW1000-118-6-D1-626
- RW1000-118-6-59A1-613
- RW1000-118-6-59A1-626
- RW1000-118-6-60-613
- RW1000-118-6-60-626
- RW1000-118-6-77-626

**2000-034 Lever Cylinders**

For use CL3000 6-Pin Series Lever Locks



**(Heavy Duty)**

- RW2000-034-D1-626
- RW2000-034-L4-626
- RW2000-034-59A1-626
- RW2000-034-60-626
- RW2000-034-77-626
- RW2000-034-981-626

**3000 Rim Cylinders**

For use with exit devices and exit device trim



**2" (std. door)**

- RW3000-200-6-D1-626
- RW3000-200-6-L4-626
- RW3000-200-6-59A1-626
- RW3000-200-6-77-626
- RW3000-200-6-981-613
- RW3000-200-6-981-626

**2200-001 Knob Cylinders**

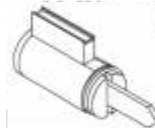

- Alarm Lock DL2500 Series
- Arrow® H Series Knobs and Levers
- Arrow® Q Series Levers
- Sargent® 10 Line (Enlarge Lever Hole)
- Schlage® D Series Levers

**626 Schlage AL/ND CYL**  
RW2200-001-A22-59B1

**2000-051 Knob Cylinders**

Series Knoblocks for B2, G2, and Exit Device Knob Trim



**(Heavy Duty) CK 4000**

RW2000-051-D1-626

**FINISHES**

- 606 Satin Brass
- 612 Satin Bronze
- 613 Dark Bronze
- 626 Satin Chrome

**8000 I/C Core Cylinders LFIC**

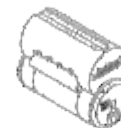

- Core IC O-Bitted
- 6-pin standard

**(Heavy Duty) CK 4000**

- RW8000-D1-6-626
- RW8000-L4-6-626
- RW8000-59A1-6-626
- RW8000-60-6-626
- RW8000-981-6-626



ML 2000 SERIES

Mortise Locksets



LL = Lock Case  
Only for Levers

Features:

- Less cylinder
- Can be re-handed without disassembling the lock case
- 1 3/4" Door thickness • 2 3/4" backset • 5 7/8" x 4" x 5/16" Lock Case
- Heavy-gauge steel, 8" x 1 3/4" x -3/16" front
- Accommodates flat doors and doors beveled 1/8" in 2"
- Furnished 1 1/8" wide for 1 3/8" doors
- 2-piece mechanical latchbolt with anti-friction insert, 5/8" x 1" x 3/4" throw
- 5/8" effective throw and 3/8" effective auxiliary latch deadlocking latchbolt

LWA

Lever: Wrought  
Rose: Wrought

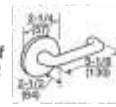

LWM

Lever: Wrought  
Escutcheon: Wrought

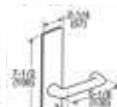

GWM

Knob: Wrought reinforced  
Escutcheon: Wrought

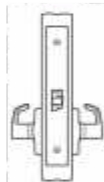
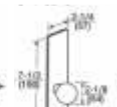

Passage / Closet

Features:

- Latchbolt by grip either side
- Both grips always free

RWML2010-LL-626  
RWML2010-LWM-626

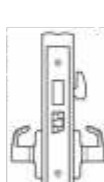

Privacy / Bedroom / Bathroom

Features:

- Latchbolt by grip either side
- Deadbolt by thumbturn lever inside or by emergency release tool outside
- Inside grip simultaneously retracts latchbolt and deadbolt

RWML2030-LL-626



Dormitory / Entrance

Features:

- Latchbolt by grip either side
- Deadbolt by key outside or by thumbturn lever inside
- Inside grip simultaneously retracts latchbolt and deadbolt

RWML2065-LL-626  
RWML2065-GWM-626-LC  
RWML2065-LWA-630-LC  
RWML2065-LWM-626-LC



Entrance / Apartment

Features:

- Latchbolt by key outside or by grip either side, unless outside grip is locked by toggle-action stop
- Deadbolt by key outside or by thumbturn lever inside
- Inside grip always free

RWML2048-LL-626  
RWML2048-LWM-626-LC

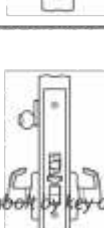

Entrance / Office

Features:

- either side, unless outside grip is locked by toggle-action stop
- Auxiliary latch deadlocks latchbolt inside grip always free

RWML2051-LL-626  
RWML2051-LWA-630-LC  
RWML2051-LWM-626-LC  
RWML2051-NSA-626-LC



Dormitory / Apartment

Features:

- Latchbolt by grip either side, unless outside grip is locked by toggle-action stop or by projection of deadbolt
- Deadbolt by key outside or by thumbturn lever inside
- Inside grip simultaneously retracts latchbolt and deadbolt; outside grip remains locked
- Auxiliary latch deadlocks latchbolt

RWML2067-LL-626  
RWML2067-LWM-626-LC

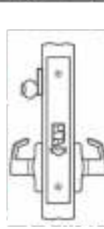

Classroom

Features:

- Latchbolt by grip either side, unless outside grip is locked by key outside
- Auxiliary latch deadlocks latchbolt
- Inside grip always free
- Requires straight cam

RWML2055-LL-626  
RWML2055-LWA-630-LC  
RWML2055-LWM-626-LC  
RWML2055-NSA-626-LC

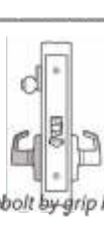

Storeroom / Closet

Features:

- outside
- Outside grip always rigid
- Auxiliary latch deadlocks latchbolt inside grip always free

RWML2057-LL-626  
RWML2057-LWA-630-LC  
RWML2057-LWM-626-LC  
RWML2051-NSA-626-LC

☐ When lever handles are furnished, both outside and inside are locked when deadbolt is projected.  
\* All require use of cloverleaf cam unless otherwise specified.

EXIT DEVICES

ED8200 Panic Listed Rim Exit Device (Rim Type)



Features:

- Non-Handed
- 1 3/4" Door thickness
- 2 3/4" Backset
- Easily "eld cut to size
- Minimum stile width 5"

RWED8200-689 Aluminum 36"  
RWED8200-689-W042 Aluminum 36"  
RWED8200-690 Dark Bronze

Standard Width	Door Range
36 in. (3ft. 0 in.)	31" to 36" inches
42 in. (3ft. 6 in.)	37" to 42" inches

Knob Trim Classroom

(Less Cylinder)



RWG1055-LC-626

Lever Trim Classroom

(Less Cylinder)



RWN655-LC-626 ED8200/8400

Wing Pull - Trim

(Less Cylinder)



RWP857-LC-689 Aluminum  
RWP857-LC-690 Dark Bronze

**DOOR CLOSER**

**DC3210 Series Door Closer**  
(With Parallel Arm Mounting)  
RWDC3210-689

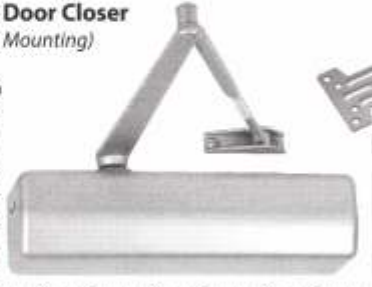

**Features:**

- Non-Handed
- Multi-sized; fully adjustable 1 through 6
- Up to full 180° opening

Parallel Arm Bracket Included With DC3210



Backcheck intensity valve with safety feature maintains safe internal pressure

Tapered valves allow infinite adjustments for correct performance (latching speed, backcheck intensity, closing speed)

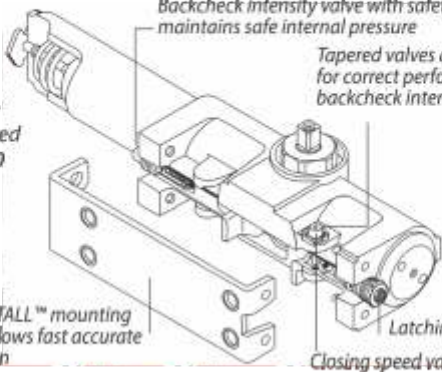













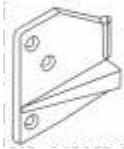



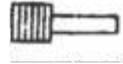

QUIK-INSTALL™ mounting bracket allows fast accurate installation

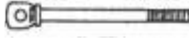
Latching speed valve

Closing speed valve

**PARTS**

 RW123F53 Dogging Wrench 3/8"	 RW144F29 Plug Driver Keyed function, 4200 series	
 RW792F997 100/Pkg		 RW499F83 33L (Lever x Lever) Spindle for 1 3/8" door
 RW696F58-8 Spindle 32 (Knob X Knob) for 1 3/8" Door	 RW416F35-689 Double Door Strike	 RW624F49-626 Armored Front 1 1/4" Std
 RW253F77-8 Tailpiece For 3000-312		
 RW217F44-2 Slide Cover Brass	 RW482F79-8 ANSI Fastening Plate Pkg for G3 Trim	 RW300F68 Thimble Wrench
 RW483F30 Dowel Screw For Inside Lever on ML2200	 RW688F17-7 Latchbolt ML2000	• Used to tighten or loosen rose thimble • Plastic coated to prevent marring the finish of the rose thimble
 RW483F35 For Spindle #499F83	 RW552F36-8 Latch for ED8200 Series	<b>2 3/4" Deadlatches</b>
 RW701F22-8 Deadbolt Spring For 3/8" throw dead bolts	 RW429F41-619 Mortise Locks	 RW600F10-626 F/CL 3600 RW586F17-626
	 Adjusting Screw, 1/8" Dr.	

**CAMS**

 RW756F507 Cam A01 Cloverleaf	 RW756F517 Cam A02 Straight	 RW756F527 Cam A03 MS for standard & LFIC & Access 3
---	---	---

## KEY BLANKS

RW27-5PIN-10	BLANK KEY	RWD1-5PIN-10	KEY BLANK
RW27-6PIN-10	BLANK KEY	RWD1-6PIN-10	KEY BLANK
RW59A1-5PIN-10	KEY BLANK	RWD2-6PIN-10	KEY BLANK
RW59A1-6PIN-10	KEY BLANK	RWD3-6PIN-10	KEY BLANK
RW59A1-6PIN-12	KEY BLANK DND	RWD4-6PIN-10	KEY BLANK
RW59A2-6PIN-10	KEY BLANK	RWD41-6PIN-10	KEY BLANK
RW59AB-6PIN-10	KEY BLANK	RWL1-6PIN-10	KEY BLANK NS COINED LOGO
RW59B1-5PIN-10	KEY BLANK	RWL2-6PIN-10	KEY BLANK NS COINED LOGO
RW59B1-6PIN-10	KEY BLANK	RWL3-6PIN-10	KEY BLANK NS COINED LOGO
RW59B2-6PIN-10	KEY BLANK	RWL4-5PIN-10	KEY BLANK NS COINED LOGO
RW59C1-6PIN-10	KEY BLANK	RWL4-6PIN-10	KEY BLANK NS COINED LOGO
RW59C2-6PIN-10	KEY BLANK	RWL4-7PIN-10	KEY BLANK NS COINED LOGO
RW59D1-6PIN-10	KEY BLANK	RWN1-6PIN-10	KEY BLANK
RW59D2-6PIN-10	KEY BLANK	RWN10-6PIN-10	KEY BLANK
RW60-5PIN-10	KEY BLANK	RWN12-6PIN-10	KEY BLANK
RW60-6PIN-10	KEY BLANK	RWN13-6PIN-10	KEY BLANK
RW67-5PIN-10	BLANK KEY	RWN15-6PIN-10	KEY BLANK
RW67-6PIN-10	BLANK KEY	RWN17-6PIN-10	KEY BLANK
RW77-5PIN-10	KEY BLANK	RWN18-6PIN-10	KEY BLANK
RW77-6PIN-10	BLANK KEY	RWN19-6PIN-10	KEY BLANK
RW77A1-5PIN-10	BLANK KEY	RWN2-6PIN-10	KEY BLANK
RW77A1-6PIN-10	BLANK KEY	RWN21-6PIN-10	KEY BLANK
RW77A2-6PIN-10	KEY BLANK	RWN25-6PIN-10	KEY BLANK
RW77AB-6PIN-10	KEY BLANK	RWN26-6PIN-10	KEY BLANK
RW852-5PIN-10	KEY BLANK	RWN3-6PIN-10	KEY BLANK
RW97-5PIN-10	BLANK KEY	RWN4-6PIN-10	KEY BLANK
RW97-6PIN-10	BLANK KEY	RWN5-6PIN-10	KEY BLANK
RW981-5PIN-10	KEY BLANK	RWN6-6PIN-10	KEY BLANK
RW981-6PIN-10	KEY BLANK	RWN7-6PIN-10	KEY BLANK
RW982-6PIN-10	KEY BLANK	RWN8-6PIN-10	KEY BLANK
RW99-5PIN-10	BLANK KEY	RWN9-6PIN-10	KEY BLANK
RW99-6PIN-10	BLANK KEY		



EXIT ALARMS

EAX-500 SERIES



Designed for applications that require an alarmed exit device on secured doors. The alarm, with approximately 100dB, will sound when someone attempts an unauthorized exit. The EAX-500, with its redesigned shape and smaller size make it the choice for quick and easy installations on emergency exit and restricted doors.

2.10" Wide x 2.375" Deep x 7.70" Long  
Cylinder not included

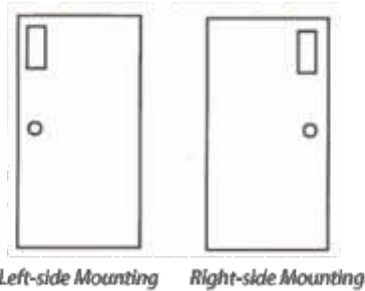

EAX-500W SERIES



Weatherized Exit Alarm is designed for applications that require an alarmed exit device on secured doors, particularly emergency exits that open to the outdoors or wet environment. The alarm, with approximately 100dB, will sound when someone attempts an unauthorized exit. The EAX-500W, with its redesigned shape and smaller size, make it the choice for quick and easy installations on emergency exit and restricted doors.

Cylinder not included



DXEAX-500      Surface Mount Gray  
DXEAX-500W      Weatherized Gray  
DX102643      Bracket Inswing EAX-500



DXEAX-2500S Exit Alarm  
Surface Mount Gray  
Battery AC Optional

Surface Mount  
Cylinder not included

Flush      4.65" Wide x 4.60" Long x 3.11" Deep  
Surface      4.65" Wide x 4.60" Long x 3.00" Deep



EAX-2500S SERIES

Designed for applications that require a 9VDC battery or external AC/DC powered alarmed exit device on secured doors. The alarm, with approximately 100dB, will sound when someone attempts an unauthorized exit. The EAX-2500, with its smaller size and designed to fit in a standard 4" x 4" outlet box makes it the choice for quick and easy installations on emergency exit and restricted doors.

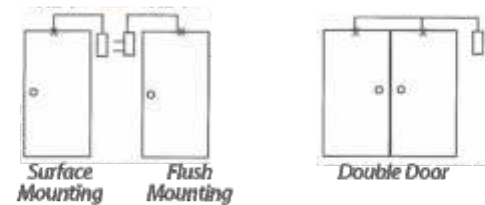

MAGNETIC SWITCHES

- Specifications:
- Surface & Flush mounted
  - Max contact ratings 24 volt @ .5 amp
  - Switch (SPDT)
  - Wiring / color coded leads, 12" long

DXMS-2049S      (Surface)  
DXMS-2049F      (Flush)

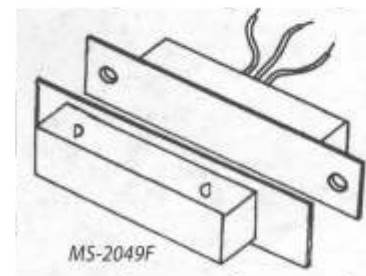
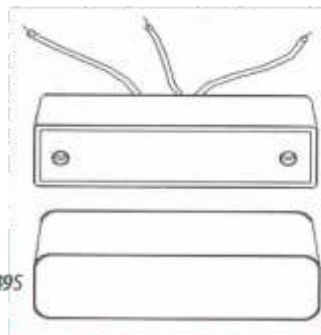

## EXIT CONTROL HARDWARE

### ECL-230 SERIES

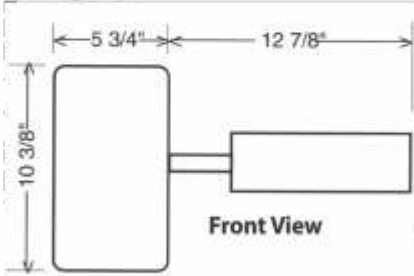

Front View

#### Features:

- Attack and corrosion resistant cast aluminum housing.
- Easy to install with basic tools.
- UL listed Panic Hardware, ADA compliant.
- ECL-230D comes with a 5 year limited warranty standard.
- Battery operated (can be converted with optional battery eliminator kits).
- Exit bar signs available in English.
- High decibel alarm horn.
- Saw resistant deadbolt, with a 1" throw.
- Outside key control available.
- Can be used with F90KR Keyed Removable Mullion, BE-961 Battery Eliminator.

DXECL-230D Exit Control Lock

### ECL-2111K

9V Conv-Kit F/ECL-230C&D

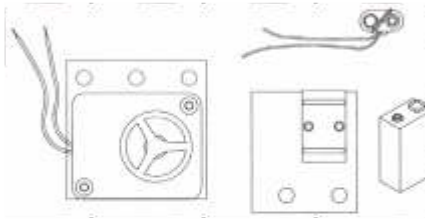

#### Physical Specifications:

- Die-cast aluminum alloy housing w/Detex Gray Vein 3 finish.
- Push plate/bar dimensions: 3 1/4" high x 12 7/8" wide
- Minimum std. door width is 20".

### DX ECL-435K

Keeper-Kit-Brk Keeper & Screws

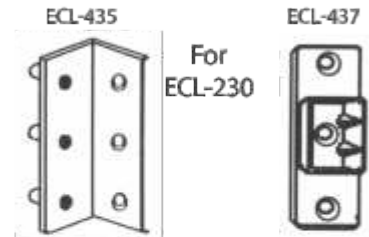

#### Includes:

- (1) ECL-435 Bracket-Keeper
- (1) ECL-437 Keeper-Surface
- (3) PP-5202-108 Screw 10-32 x 1/2 FH
- (3) PP-5192-68 Screw #10-1 FH

### DX PP-5572

Cover Lock W/2 DT11 Keys  
For EAX-500, EA-500 & ECL-230



DXPP-5572-11  
DXPP-5572-12  
DXPP-5572-13  
DXPP-5572-14  
DXPP-5572-15

DXPP-5572-16  
DXPP-5572-17  
DXPP-5572-18  
DXPP-5572-19  
DXPP-5572-20

### DX ECL-475K

Glass Door Backplate Kit



For Use  
On 230D

To improve appearance of the back of an Exit Control Lock visible through glass on narrow stile door. Dimensions: 5 7/8" W x 10 3/8" H x .045" thick.  
Note: Minimum width of narrow style glass door is 2 1/4".

DXECL-475K

### DX BE-961-1

Battery Eliminator 6VOR9V  
Powers 3 ECL-230D'S



DXBE-961-1 Battery Eliminator

### DX PP-5152-3

Transformer 12VAC  
Hard Wire Type

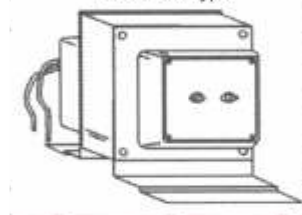

DXPP-5152-3 Transformer 12VAC  
DXPP-5152-2 Transformer 24VAC, 40VA

**PARTS**

**ECL-230D  
Exploded View**

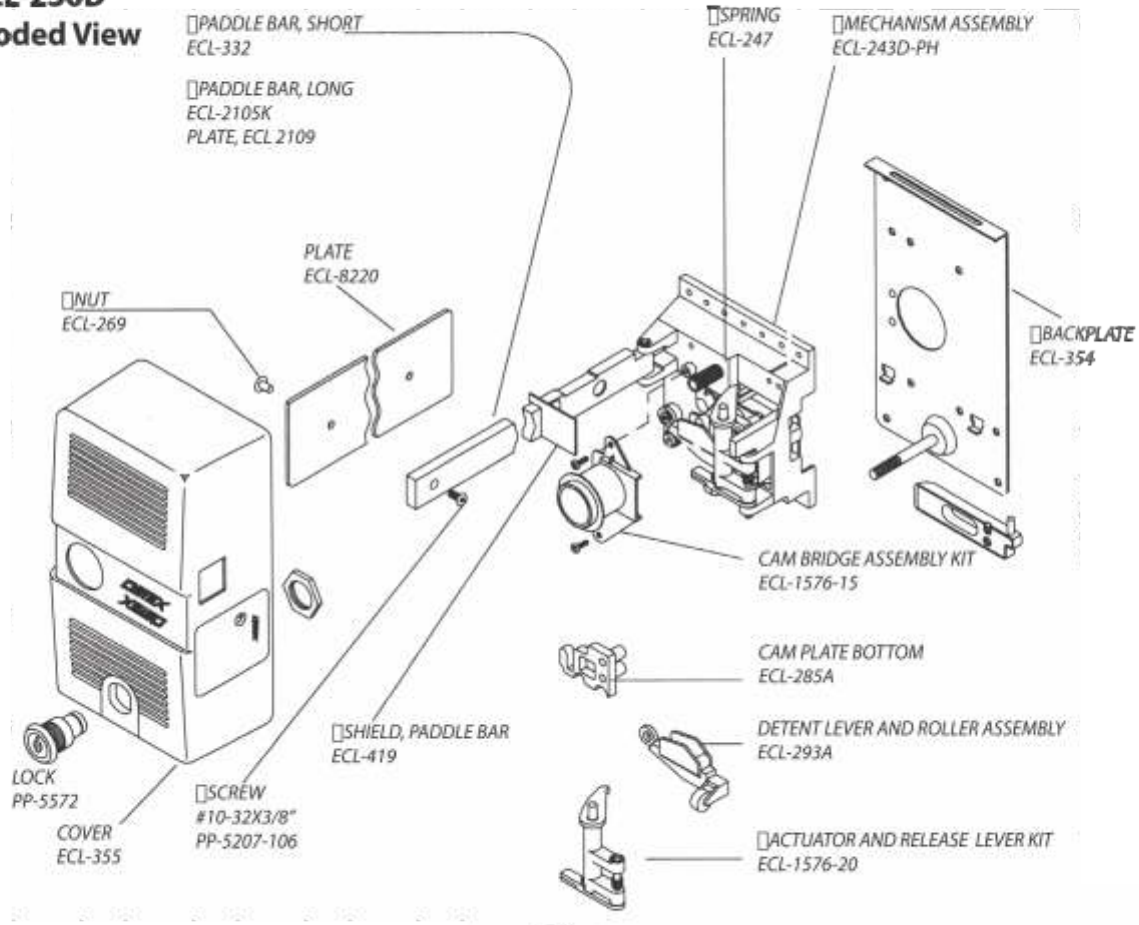

**(NOT STOCKED)**

**PARTS LISTED BELOW:  
FOR 1993 THROUGH CURRENT DEVICES**

**Part Number**

- DX100069 Siren, Switch & Bracket SDX
- DX101796 Switch Actuator Kit
- DX102636-1 Monitors Deadbolt Kit (not pictured)
- DX102636-2 Monitors Key Switch
- DXECL-355 Cover Assy for 230D
- DXECL-1576-15 Cam Bridge Assy Kit
- DXECL-8220 Paddle Plate

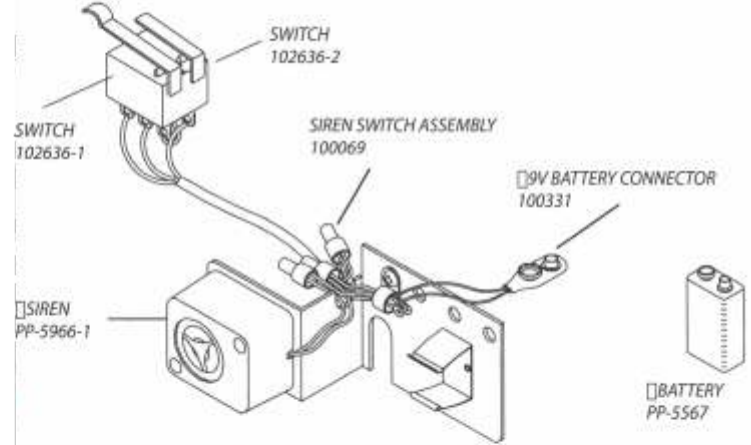

**500 SERIES PARTS**

**Part Number**

DXEA-561 Sign: Emergency Exit Only

**EMERGENCY EXIT ONLY  
ALARM WILL SOUND**

**EA-561**

DXECL-405-KIT

KEY CUT-STAMPED (10/SET)



## ADVANTEX SERIES

<p>03Z-630-LHR</p> 	<p>03Z-630-RHR</p> 	<p>10-HD-630-99-36</p>	<p>DX03Z-630-LHR     <i>Key Retracts Latch Vandal Pull</i>          DX03Z-630-RHR     <i>Key Retracts Latch Vandal Pull</i>          DX10-HD-630-99-36     <i>Advantex Wide Stile Rim Exit</i></p>
--	--	------------------------	--

## PANIC HARDWARE

The V40xEB device option is designed for doors that require a stand alone, battery powered, alarmed panic device. The alarm, with approximately 100dB, will sound when someone attempts to exit, alerting management that an unauthorized exit has occurred. With electronic switching that monitors the latch bolt, the V40xEB provides a high level of security while also meeting all life safety concerns. The V40xEB is UL listed as Grade 1 panic and fire exit hardware as well as UBC standard 7-2 (positive pressure).

- UL Listed as Grade 1 Panic/Fire Exit Hardware
- Exceeds Life Safety, ADA, CA Title 19, ANSI/BHMA requirements and all building codes
- All units shipped less control cylinder (Fire Rated Device must be less dogging)
- All units include #99 surface strike
- Standard Finish: Aluminum (628) baseplate, red push pad with white warning letters, and black (711) cover, filler plate and end cap
- Standard 9V battery supplied with each device



### Physical Characteristics:

- Exterior of anodized aluminum and damage and corrosion resistant ABS for years of heavy use.
- Stainless-steel, dead-latching bolt with a 3/4" throw.
- 36" fits 34" to 36" doors

Battery Powered Exit Alarm (9VDC) for 36" door, less control cylinder

- Length - 33"
- Height of cover 8 1/2"
- Profile from face of door - Un-dogged 3 1/4", dogged 2 3/8"

- Fits 2" narrow stile doors with Narrow Stile Door Kit (sold separately)

### Part Number

- |               |   |
|---------------|---|
| DXV40EB-36"   | Weatherized Battery Powered Exit Alarm (9VDC) for 36" door, less control cylinder |
| DXV40EB-W-36" | Pull Trim (Portland) Less Rim Cylinder  |
| DX03P-628     | Cylinder Trim (Willow Springs) Less Rim Cylinder                                  |
| DX03WS-626    | Narrow Stile Door Kit (628 Finish)  |
| DX101879-1    | Fillerplate with Alarm  |
| DX104358-4    | V40EB Endcap  |

### Side View

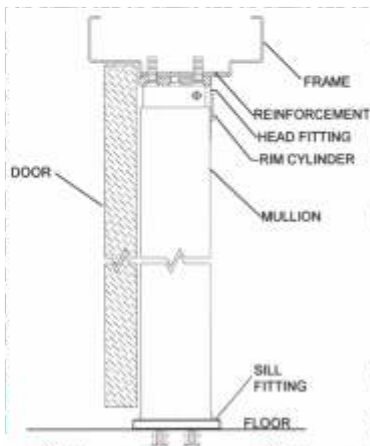

### DX F90KR

#### Keyed Removable Mullion

The Detex Keyed Removable Mullions are very durable, low cost mullions designed for use with rim exit devices on standard and fire rated pairs of doors. The unique design of the latching head allows the mullion to be removed in seconds with one key turn, and then to be snapped back into place without needing the key.

#### Features:

- 3hour Fire Rated
- Mullion length 8 ft. easy to Seld-cut to length
- 11 gage, 2"x 3" tube
- Operated by standard rim cylinder
- Self-latching - no need to reinsert the key to engage the mullion tube     *Keyed Mullion*

#### Part Number

DXF90KR

DIPENSER KEY SETS



- |             |                                |
|-------------|--------------------------------|
| DK1100-6    | SCA / TORK 1100 DISPENSER KEY  |
| DK1200-6    | BAYWEST 1200 DISPENSER KEY     |
| DK50411-6   | UNIVERSAL WAFFLE DISPENSER KEY |
| DK50415-12  | E114 DISPENSER KEY 12-PACK     |
| DK50415-25  | E114 DISPENSER KEY 25-PACK     |
| DK50415-50  | E114 DISPENSER KEY 50-PACK     |
| DK50504-12  | GEORGIA PACIFIC CORMATIC       |
| DK50504-25  | GEORGIA PACIFIC CORMATIC       |
| DK770301-6  | KIMBERLY CLARK PAPER TOWEL     |
| DK770767    | KIMBERLY CLARK CROSS           |
| DKBR2055-6  | 2055 DISPENSER KEY 6-PACK      |
| DKMSTRSET-1 | MASTER DISPENSER KEY RING SET  |

# DON-JO MFG., INC.

STRENGTHENING DOORS FOR OVER 20 YEARS



FROM STOCK ITEMS TO CUSTOM-MADE PRODUCTS, DON-JO SUPPLIES ALL OF YOUR ACCESSORY NEEDS



## WRAP-AROUNDS

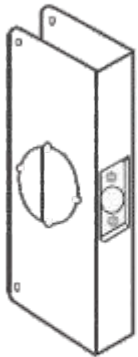

1-CW  
2-CW  
3-CW  
4-CW

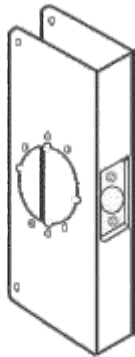

4-2-CW

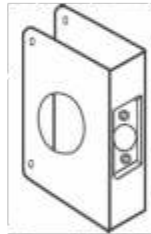

5-CW  
6-CW  
7-CW  
8-CW



15-CW



14-CW



14-2-CW

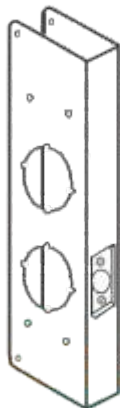

16-CW

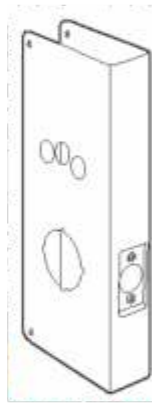

18-CW

Part No.	Backset	Door	Dimensions	Finish
For Cylindrical Door Locks With 2 1/2" Hole				
DJ1-AB-CW	2 3/8"	1 3/8"	4" x 9"	Antique Brass
DJ1-PB-CW	2 3/8"	1 3/8"	4" x 9"	Polished Brass
DJ1-S-CW	2 3/8"	1 3/8"	4" x 9"	Stainless Steel
DJ2-AB-CW	2 3/8"	1 3/4"	4" x 9"	Antique Brass
DJ2-PB-CW	2 3/8"	1 3/4"	4" x 9"	Polished Brass
DJ2-S-CW	2 3/8"	1 3/4"	4" x 9"	Stainless Steel
DJ3-AB-CW	2 3/4"	1 3/8"	4 1/4" x 9"	Antique Brass
DJ3-PB-CW	2 3/4"	1 3/8"	4 1/4" x 9"	Polished Brass
DJ3-S-CW	2 3/4"	1 3/8"	4 1/4" x 9"	Stainless Steel
DJ4-AB-CW	2 3/4"	1 3/4"	4 1/4" x 9"	Antique Brass
DJ4-BZ-CW	2 3/4"	1 3/4"	4 1/4" x 9"	Bronze
DJ4-PB-CW	2 3/4"	1 3/4"	4 1/4" x 9"	Polished Brass
DJ4-S-CW	2 3/4"	1 3/4"	4 1/4" x 9"	Stainless Steel
For Use With Heavy Duty Grade 1 & Grade 2 Key-In-Levers				
DJ4-BZ-2-CW	2 3/4"	1 3/4"	4 3/4" x 9"	Bronze
DJ4-PB-2-CW	2 3/4"	1 3/4"	4 3/4" x 9"	Polished Brass
DJ4-S-2-CW	2 3/4"	1 3/4"	4 3/4" x 9"	Stainless Steel
For Deadbolts With 1 1/2" Hole				
DJ6-AB-CW	2 3/8"	1 3/4"	4" x 4 1/2"	Antique Brass
DJ6-PB-CW	2 3/8"	1 3/4"	4" x 4 1/2"	Polished Brass
DJ6-S-CW	2 3/8"	1 3/4"	4" x 4 1/2"	Stainless Steel
DJ7-S-CW	2 3/4"	1 3/8"	4 1/4" x 4 1/2"	Stainless Steel
DJ8-AB-CW	2 3/4"	1 3/4"	4 1/4" x 4 1/2"	Antique Brass
DJ8-BZ-CW	2 3/4"	1 3/4"	4 1/4" x 4 1/2"	Bronze
DJ8-PB-CW	2 3/4"	1 3/4"	4 1/4" x 4 1/2"	Polished Brass
DJ8-S-CW	2 3/4"	1 3/4"	4 1/4" x 4 1/2"	Stainless Steel

For Conversion of Simplex 1000 Series & Alarm Lock DL2500, 2700/T2 & 3000 Series				
DJ14-S-CW	2 3/4"	1 3/4"	5" x 14"	Stainless Steel
DJ14-S-2-CW	2 3/4"	1 3/4"	5" x 14"	Stainless Steel
Fits Simplex/Unican 1000 Series				
DJ15-AB-CW	2 3/4"	1 3/4"	5" x 15"	Antique Brass
DJ15-S-CW	2 3/4"	1 3/4"	5" x 15"	Stainless Steel
Fits SCHLAGE COBRA LOCKS				
DJ18-S-CW	2 3/4"	1 3/4"	5" x 15"	Stainless Steel

**WRAP-AROUNDS — continued**

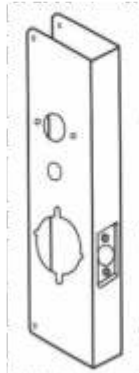

27-CW



30-CW  
40-CW  
80-CW

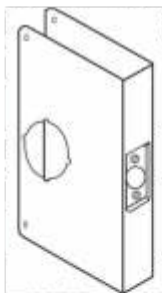

55-CW

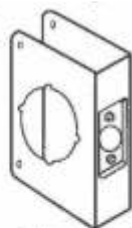

51-CW  
61-CW  
71-CW  
81-CW

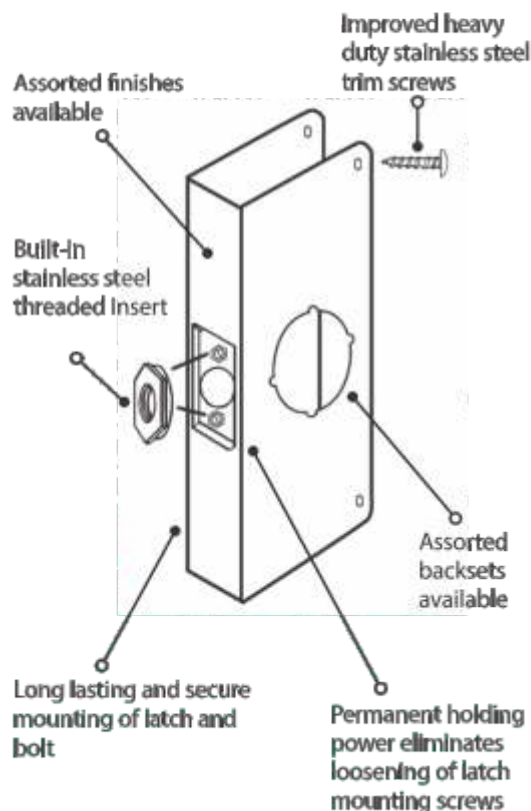

Part No.	Backset	Door	Dimensions	Finish
20" Wrap Arounds				
DJ20-S-CW	2 3/4"	1 3/8"	5" X 20"	Stainless Steel
DJ20-S-2-CW	2 3/4"	1 3/8"	5 3/4" X 20"	Stainless Steel
For Arrow Revolution & Yale InTouch				
DJ25-S-CW	2 3/4"	1 3/8"	5" x 15"	Stainless Steel
For Schlage CO Locks				
DJ26CO-S-CW	2 3/4"	1 3/8"	5" x 15"	Stainless Steel
Fits Alarm Lock 2700/T2 and 3000 Series Trilogy Lock				
DJ27-PB-CW	2 3/4"	1 3/8"	5" x 15"	Polished Brass
DJ27-S-CW	2 3/4"	1 3/8"	5" x 15"	Stainless Steel
Blank Wrap-Around with Trim Screws				
DJ30-PB-CW	-	1 3/8"	4 1/4" x 9"	Polished Brass
DJ40-BZ-CW	-	1 3/8"	4 1/4" x 9"	Bronze
DJ40-PB-CW	-	1 3/8"	4 1/4" x 9"	Polished Brass
DJ40-S-CW	-	1 3/8"	4 1/4" x 9"	Stainless Steel
For Cylindrical Door Locks with 2 1/8" Hole				
DJ51-AB-CW	2 3/8"	1 3/8"	4" x 4 1/2"	Antique Brass
DJ51-PB-CW	2 3/8"	1 3/8"	4" x 4 1/2"	Polished Brass
For Locks with Extended or Converted Backsets				
DJ55-S-CW	5"	1 3/8"	6 1/2" x 9"	Stainless Steel
For Cylindrical Door Locks with 2 3/8" Hole				
DJ61-AB-CW	2 3/8"	1 3/8"	4" x 4 1/2"	Antique Brass
DJ61-PB-CW	2 3/8"	1 3/8"	4" x 4 1/2"	Polished Brass
DJ61-S-CW	2 3/8"	1 3/8"	4" x 4 1/2"	Stainless Steel
For Cylindrical Door Locks with 2 1/2" Hole				
DJ71-PB-CW	2 3/4"	1 3/8"	4 1/4" x 4 1/2"	Polished Brass
DJ71-S-CW	2 3/4"	1 3/8"	4 1/4" x 4 1/2"	Stainless Steel
Blank Wrap-Around with Trim Screws				
DJ80-PB-CW	-	1 3/8"	4 1/4" x 4 1/2"	Polished Brass
DJ80-S-CW	-	1 3/8"	4 1/4" x 4 1/2"	Stainless Steel
For Cylindrical Door Locks with 2 3/8" Hole				
DJ81-AB-CW	2 3/8"	1 3/8"	4 1/4" x 4 1/2"	Antique Brass
DJ81-BZ-CW	2 3/8"	1 3/8"	4 1/4" x 4 1/2"	Bronze
DJ81-PB-CW	2 3/8"	1 3/8"	4 1/4" x 4 1/2"	Polished Brass
DJ81-S-CW	2 3/8"	1 3/8"	4 1/4" x 4 1/2"	Stainless Steel

**WRAP-AROUNDS — continued**

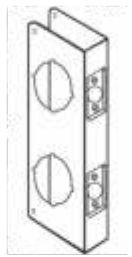

261-CW  
481-CW

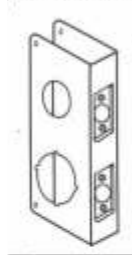

264-CW  
484-CW

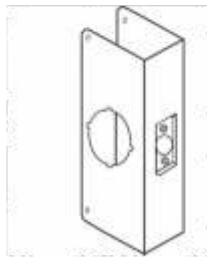

214-CW

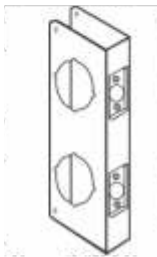

481-CW

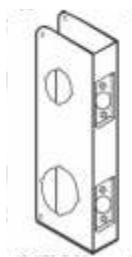

484-CW

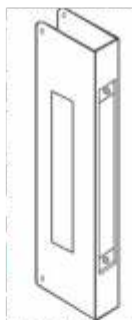

514-CW



4U-2-CW

Part No.	Backset	Door	Dimensions	Finish
For Thicker Doors				
DJ214-PB-CW	2 3/4"	2 1/4"	4 1/2" x 9"	Polished Brass
DJ214-S-CW	2 3/4"	2 1/4"	4 1/2" x 9"	Stainless Steel
For Double Lock Combination Locksets with 2 1/8" holes with 3 3/8" centers				
DJ261-AB-CW	2 3/8"	1 3/4"	4" x 9"	Antique Brass
DJ261-PB-CW	2 3/8"	1 3/4"	4" x 9"	Polished Brass
For Double Lock Combination Locksets with 1 1/2" Hole on Top and 2 1/8" Hole on Bottom with 4" Centers				
DJ264-PB-CW	2 3/8"	1 3/4"	4" x 9"	Polished Brass
DJ264-S-CW	2 3/8"	1 3/4"	4" x 9"	Stainless Steel
For Double Lock Combination Locksets with 2 1/8" Holes with 3 3/8" Centers				
DJ481-PB-CW	2 3/4"	1 3/4"	4 1/2" x 9"	Polished Brass
DJ481-S-CW	2 3/4"	1 3/4"	4 1/2" x 9"	Stainless Steel
For Double Lock Combination Locksets with 1 1/2" Hole on Top and 2 1/8" Hole on Bottom with 4" Centers				
DJ484-AB-CW	2 3/4"	1 3/4"	4 1/2" x 9"	Antique Brass
DJ484-PB-CW	2 3/4"	1 3/4"	4 1/2" x 9"	Polished Brass
DJ484-S-CW	2 3/4"	1 3/4"	4 1/2" x 9"	Stainless Steel
Mortise Lock Wrap-Around Plate for 86 Cut-Out				
DJ514-S-CW	2 3/4"	1 3/4"	5" x 12"	Stainless Steel
Fits Simplex / Unican 5000 Series				
DJ5000-S-CW	2 3/4"	1 3/4"	5" x 15"	Stainless Steel
Fits E-Plex 2000 Series				
DJE2000-S-CW	2 3/4"	1 3/4"	5" x 15"	Stainless Steel
Unit Lock to Lever Conversion				
DJ4U-2-S-CW	2 3/4"	1 3/4"	4 1/2" x 5"	Stainless Steel

**DOOR REINFORCER**

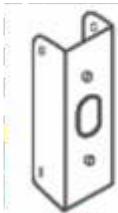

**DJ10-FE**  
Door Reinforcer  
For deadbolts and key-in-knob locks.  
Door: 1 3/4" Dimensions: 4 1/2" x 1"

- DJ10-AB-FE      Antique Brass
- DJ10-PB-FE      Polished Brass

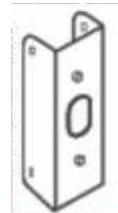

**DJ20-FE**  
Door Reinforcer  
For deadbolts and key-in-knob locks.  
Door: 1 3/4" Dimensions: 4 1/2" x 1"

- DJ20-AB-FE      Antique Brass
- DJ20-PB-FE      Polished Brass
- DJ20-S-FE        Stainless Steel



## STRIKES

### ANSI STRIKES



Mortise Strike  
Polybagged



Standard ANSI  
Polybagged

Product No.	Dimensions	Finish
DJMST-261-SL	4 7/8" x 1 1/4"	Silver Coated
DJST-161-605	4 7/8" x 1 1/4"	Polished Brass
DJST-161-630	4 7/8" x 1 1/4"	Stainless Steel
DJST-261-SL	4 7/8" x 1 1/4"	Silver Coated
DJST-214-630	2 1/4" x 1 1/4"	Stainless Steel



T-Strike  
Polybagged

### REPLACEMENT STRIKES

Product No.	Dimensions	Finish
DJ9234-605	2 3/4" x 1 1/8"	Bright Brass
DJ9234-630	2 3/4" x 1 1/8"	Stainless Steel
DJDS-234-630	2 3/4" x 1 1/8"	Stainless Steel
DJDS-V 234-630	2 3/4" x 1 1/8"	Stainless Steel

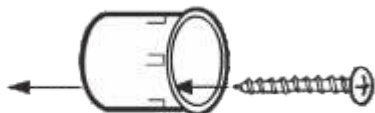

Thimble Strike  
Polybagged

### THIMBLE STRIKE

Product No.	Dimensions	Finish
DJTS-100-CP	1" Diameter	Chrome Plated
DJTS-200-CP		

### SECURITY STRIKES



DJSDS  
For Deadbolt



DJSDS-8  
Super Strike for Dead-  
bolt

Product No.	Dimensions	Finish
DJ2-SDS-BP	4 7/8" x 1 1/4"	Brass Plated
DJ2-SDS-SL	4 7/8" x 1 1/4"	Steel Silver Coated
DJ2-SDS-8-BP	8" x 1 3/8"	Brass Plated
DJ2-SDS-8-SL	8" x 1 3/8"	Steel Silver Coated



9450 Series

### ADJUSTABLE STRIKES

Product No.	Dimensions	Finish
DJ9450-CP	4 7/8"	Dull Chrome

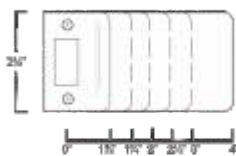

EL-102-3  
EL-103-3  
EL-125-3  
9102-605-Polybagged  
9102-630-Polybagged

### EXTENDED LIP STRIKE

Product No.	Dimensions	Finish
DJEL-102-3	2 1/4" x 2"	Bright Brass
DJEL-103-3	2 1/4" x 3"	Bright Brass
DJEL-125-3	2 1/4" x 2 1/2"	Bright Brass
DJ9102-630	2 1/4" x 2"	Stainless Steel
DJETS-102-3	2 3/4" x 2"	Bright Brass
DJETS-103-3	2 3/4" x 3"	Bright Brass
DJETS-125-3	2 3/4" x 2 1/2"	Bright Brass

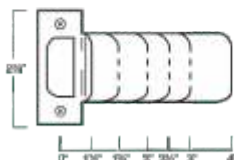

ETS-102-3  
ETS-103-3  
ETS-125-3

## STRIKES — continued

### SERIES-8, SERIES-12 AND SERIES-18 STRIKES

Product No.	Description	Dimensions	Finish
DJFL-208N-BP	Polybagged - Strike 8" Double Style	8" x 1 3/8"	Brass Plated
DJFL-208W-BP	Polybagged - Strike 8" Single Hole	8" x 1 3/8"	Brass Plated
DJFL-208WM-BP	Polybagged - Strike 8" Mortise Hole	8" x 1 3/8"	Brass Plated
DJAST-21346-BP	Polybagged - Strike 18" Double (6"CTC)	18" x 1 3/4"	Brass Plated
DJFL-212W4-BP	Polybagged - Strike 12" Double (4"CTC)	12" x 1 3/4"	Brass Plated
DJFL-212W6-BP	Strike 12" Double (6"CTC)	12" x 1 3/4"	Brass Plated
DJFL-212W6-SL	Strike 12" Double (6"CTC)	12" x 1 3/4"	Silver Coated
DJFL-212W-BP	Polybagged - Strike 12" Single Hole	12" x 1 3/4"	Brass Plated
DJFL-212WM-BP	Polybagged - Strike 12" Mortise Hole	12" x 1 3/4"	Brass Plated



**FL-208W-BP  
FL-212W-BP**  
Single hole version designed to work with key-in-knob or deadbolt



**FL-208WM-BP  
FL-212WM-BP**  
Mortise hole version with "universal" center hole



**FL-212W4-BP**  
Double hole version designed to accommodate both 3-5/8" & 4" centered locksets



**AST-21346-BP  
FL-212W6-BP**  
Double hole version designed to accommodate 6" center holes

## LATCH PROTECTORS



Product No.	Product	Description	Dimensions	Finish
<b>The INTERLOCK For Inswinging Doors</b>				
DJILP-206-BP		<ul style="list-style-type: none"> <li>• 6" version for use with key-in-knob and deadbolt locks</li> <li>• 12" version for use with Mortise Locks, Simplex 1000 series, Alarm Lock DL-2500, DL-2700 &amp; 3000, Card Access Systems, etc</li> </ul>	6"	Brass Plated
DJILP-206-DU			6"	Duro Coated
DJILP-206-SL			6"	Silver Coated
DJILP-212-DU			12"	Duro Coated
DJILP-212-SL			12"	Silver Coated
<b>For ALUMINUM ENTRANCE Doors</b>				
DJLP-307-DU		<ul style="list-style-type: none"> <li>• Reversible and fits over cylinder - lock removal NOT required</li> <li>• Hand carriage bolt and rivet supplied</li> <li>• No specific tools required</li> <li>• 3/8" offset</li> </ul>	2 5/8" x 7" x 1/8"	Duro Coated
DJLP-307-SL			2 5/8" x 7" x 1/8"	Silver Coated
DJLP-312-DU			2 5/8" x 12" x 1/8"	Duro Coated
DJLP-312-SL			2 5/8" x 12" x 1/8"	Silver Coated
<b>The INTERLOCK For Inswinging Doors</b>				
DJGLP-307-DU-LHR		<ul style="list-style-type: none"> <li>• Fits over cylinder - lock removal NOT required</li> <li>• Hand carriage bolt and rivet supplied</li> <li>• No specific tools required</li> <li>• 3/8" offset</li> <li>• Center of cylinder hole is 2 1/2" from end of plate</li> </ul>	2 5/8" x 7" x 1/8"	Duro Coated
DJGLP-307-DU-RHR			2 5/8" x 7" x 1/8"	Duro Coated
DJGLP-307-SL-LHR			2 5/8" x 7" x 1/8"	Silver Coated
DJGLP-307-SL-RHR			2 5/8" x 7" x 1/8"	Silver Coated
<b>For Use With CENTER HUNG OUTSWINGING ALUMINUM Doors</b>				
DJOLP-2650-DU		<ul style="list-style-type: none"> <li>• Available in 1 1/8" and 1 3/8" offset</li> <li>• Polybagged</li> </ul>	2 5/8" x 6 1/2" x 1 1/8"	Duro Coated
DJOLP-2650-SL			2 5/8" x 6 1/2" x 1 1/8"	Silver Coated
DJOLP-2651-DU			2 5/8" x 6 1/2" x 1 1/8"	Duro Coated

**LATCH PROTECTORS** — *continued*





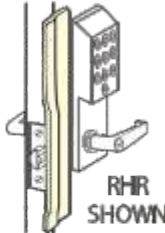
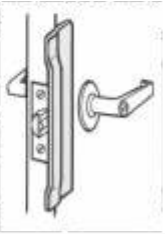
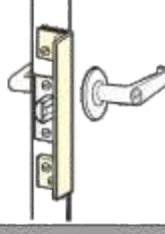
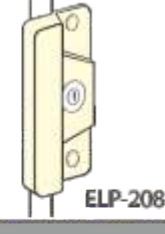

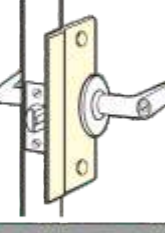
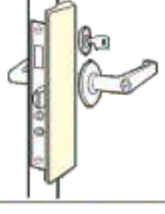



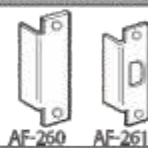

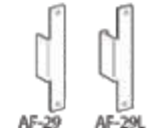
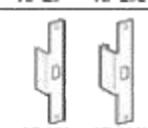
Product No.	Product	Description	Dimensions	Finish
For OUTSWINGING DOORS				
DJLP-207-DU		<ul style="list-style-type: none"> <li>• Furnished with carriage bolts, washers &amp; acorn cap nuts for safety and strength</li> </ul>	2 3/4" x 7"	Duro Coated
DJLP-207-SL			2 3/4" x 7"	Silver Coated
America's Favorite For OUTSWINGING DOORS - Completely Covers The Strike Plate				
DJLP-211-DU		<ul style="list-style-type: none"> <li>• Furnished with carriage bolts, washers &amp; acorn cap nuts for safety and strength</li> <li>• Fits 2 3/4" and 2 3/8" backsets</li> <li>• Product 9211 Polybagged</li> </ul>	3" x 11"	Duro Coated
DJLP-211-SL			3" x 11"	Silver Coated
DJ9211-SL			3" x 11"	Silver Coated
Pin Latch Protectors For OUTSWINGING DOORS				
DJPLP-211-DU		<ul style="list-style-type: none"> <li>• For MORTISE LOCKS</li> <li>• Solid steel pin prevents spreading of door from frame</li> <li>• Pin is welded on back leaving no visible point of attack from outside</li> <li>• Fits 2 3/4" and 2 3/8" backsets</li> <li>• Polybagged</li> </ul>	3" x 11"	Duro Coated
DJPLP-211-SL			3" x 11"	Silver Coated
DJPULP-111-630			3" x 11"	Stainless Steel
Pin Latch Protectors For OUTSWINGING DOORS				
DJPMLP-211-DU		<ul style="list-style-type: none"> <li>• Solid steel pin prevents spreading of door from frame</li> <li>• Pin is welded on back leaving no visible point of attack from outside</li> <li>• Polybagged</li> </ul>	3" x 11"	Duro Coated
DJPMLP-211-SL			3" x 11"	Silver Coated
For Outswing Aluminum Entrance Doors				
DJAL-211-DU		<ul style="list-style-type: none"> <li>• Sex nuts and bolts for secure mounting and professional appearance</li> </ul>	3 1/2" x 12"	Duro Coated
DJAL-211-SL			3 1/2" x 12"	Silver Coated
For KEY-IN-LEVER Locks With Up To 3 1/4" ESCUTCHEON				
DJBLP-110-630	  BLP-110      BLP-207	<ul style="list-style-type: none"> <li>• Works with up to 3 3/4" rose</li> <li>• Concealed welded studs with fasteners</li> <li>• Polybagged</li> </ul>	3 1/4" x 10"	Stainless Steel
DJBLP-107-630			3 1/4" x 7"	Stainless Steel
DJBLP-207-DU			3 1/4" x 7"	Duro Coated
DJBLP-207-SL			3 1/4" x 7"	Silver Coated















**LATCH PROTECTORS — continued**

Product No.	Product	Description	Dimensions	Finish
For ELECTRONIC LOCKS				
DJKLP-110-630-LHR	 <p>RHR SHOWN</p>	<ul style="list-style-type: none"> <li>• Works with ILCO 1000, 4000</li> <li>• Alarm Lock Trilogy Locks</li> <li>• Mas-Hamilton Power Levers</li> <li>• Schlage Cobra</li> <li>• Marks I-Q</li> <li>• Polybagged</li> </ul>	1 ½" x 10"	Stainless Steel
DJKLP-110-630-RHR			1 ½" x 10"	Stainless Steel
NARROW COMMERCIAL TYPE For OUTSWINGING DOORS				
DJNLP-206-DU		<ul style="list-style-type: none"> <li>• Polybagged</li> <li>• 6" for key-in-knobs, 10" for Mortise Locks</li> <li>• 12 Gauge (.104)</li> </ul>	1 ½" x 6"	Duro Coated
DJNLP-206-SL			1 ½" x 6"	Silver Coated
DJNLP-210-DU			1 ½" x 10"	Duro Coated
DJNLP-210-SL			1 ½" x 10"	Silver Coated
ANGLE TYPE For OUTSWINGING DOORS				
DJALP-206-SL		<ul style="list-style-type: none"> <li>• 6" for key-in-knobs</li> <li>• 1 ½" sheet metal screws for wood or metal</li> <li>• Polybagged</li> </ul>	6"	Silver Coated
For Use With ELECTRIC STRIKES				
DJELP-208-SL	 <p>ELP-208</p>	<p>Fits up to 3 ¾" Rose</p>  <p>LELP-208</p> <ul style="list-style-type: none"> <li>• Available with or without cylinder hole</li> <li>• Designed to fit most electric strikes</li> <li>• Completely encases the keeper for maximum protection</li> <li>• Polybagged</li> </ul>	3 ½" x 8"	Silver Coated
DJELP-208-DU			3 ½" x 8"	Duro Coated
DJELP-208-SL			3 ½" x 8"	Silver Coated
DJELP-208-DU			3 ½" x 8"	Duro Coated
DJMELP-210-SL			2 ¾" x 10"	Silver Coated
SHORT TYPE For OUTSWINGING DOORS				
DJSLP-206-SL		<ul style="list-style-type: none"> <li>• Furnished with carriage bolts, washers &amp; acorn cap nuts for safety and strength</li> <li>• May be used on hollow metal door/frame using ANSI strike</li> <li>• Works with up to 3 ¾" rose</li> </ul>	2 ½" x 6"	Silver Coated
SLIMLINE For OUTSWINGING DOORS				
DJLP-2878-SL		<ul style="list-style-type: none"> <li>• Fasteners included</li> <li>• Sleek appearance</li> <li>• Polybagged</li> </ul>	1 ½" x 8 ¾"	Silver Coated

## FILLER PLATES

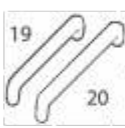
Product No.	Product	Description	Dimensions	Finish
ALUMINUM FRAME FILLER plates fit selected Folger Adams, Von Duprin, and Rofu numbers				
DJAF-260-DU		<ul style="list-style-type: none"> <li>• Electric Strike Filler</li> <li>• Fits selected Folger Adams, Von Duprin, and Rofu numbers</li> <li>• Polybagged</li> </ul>	4 7/8" x 1 1/4"	Duro Coated
DJAF-260-SL			4 7/8" x 1 1/4"	Silver Coated
DJAF-261-DU			4 7/8" x 1 1/4"	Duro Coated
DJAF-261-SL			4 7/8" x 1 1/4"	Silver Coated
DJ MAF261DU				
DJ MAF261SL				
DJ SMAF261DU				
DJ SMAF261SL				
DJAF-29-SL		<ul style="list-style-type: none"> <li>• Electric Strike Filler</li> <li>• Fits selected Folger Adams, Von Duprin, and Rofu numbers</li> <li>• Polybagged</li> </ul>	9" x 1 3/8"	Silver Coated
DJAF-291-SL		<ul style="list-style-type: none"> <li>• Electric Strike Filler</li> <li>• Fits selected Folger Adams, Von Duprin, and Rofu numbers</li> <li>• Polybagged</li> </ul>	9" x 1 3/8"	Silver Coated
DJAF-291L-SL			9" x 1 3/8"	Silver Coated
FILLER PLATES				
DJFF-45		<ul style="list-style-type: none"> <li>• Frame hinge cut out</li> <li>• Polybagged</li> </ul>	4 1/2" x 1 3/8"	Prime Coat
DJFS-260-PC		<ul style="list-style-type: none"> <li>• ANSI strike cut out</li> <li>• Polybagged</li> </ul>	4 7/8" x 1 1/4"	Prime Coat
DJHS-060		<ul style="list-style-type: none"> <li>• 16 (.060) Gauge Hinge shim</li> <li>• Polybagged</li> </ul>	4 1/2" Shims	Prime Coat
DJHS-090		<ul style="list-style-type: none"> <li>• 13 (.090) Gauge Hinge shim</li> <li>• 4 1/2" Shims</li> <li>• Polybagged</li> </ul>	4 1/2" Shims	Prime Coat
FILLER PLATE KITS				
DJFPK-86		<ul style="list-style-type: none"> <li>• For 86 cut out</li> <li>• Contains EF-86 and FS-260</li> <li>• Polybagged</li> </ul>	----	Prime Coat
DJFPK-161		<ul style="list-style-type: none"> <li>• For 161 cut out</li> <li>• Contains BF-161/EF-161FS-260</li> <li>• Polybagged</li> </ul>	----	Prime Coat
FILLER PLATE MORTISE DOOR				
DJCV-86		<ul style="list-style-type: none"> <li>• Converts 86 cut out to 161</li> <li>• Polybagged</li> </ul>	8" x 1 1/4"	Prime Coat
DJCV-2414-SL		<ul style="list-style-type: none"> <li>• Converts Sargent's Integra locks</li> <li>• Polybagged</li> </ul>	4 1/4" x 1 1/4"	Silver Coated
DJEF-86		<ul style="list-style-type: none"> <li>• 86 cut out</li> <li>• Polybagged</li> </ul>	8" x 1 1/4" x 1/16"	Prime Coated

**FILLER PLATES — continued**

Product No.	Product	Description	Dimensions	Finish		
<b>FILLER PLATES</b>						
DJEF-160	 EF-160 EF-161	• EF-160 - 160 cut out • EF-161 - 161 cut out • Polybagged	2 ¼" x 1"	Prime Coat		
DJEF-161			2 ¼" x 1 ½"	Prime Coat		
DJEF-161-CP			2 ¼" x 1 ½"	Chrome Plated		
DJEF-634		• Polybagged	6 ¾" x 1"	Prime Coat		
<b>HOLE FILLER PLATES</b>						
DJAR-335-630	 AR-335	• Allows for use of levers on 1 ½" door	3 ½" Dia.	Stainless Steel		
DJBF-135-PC	 BF-135	• Covers up to 3 ¾" hole	3 ¾" Dia.	Prime Coat		
DJBF-161-BP	 BF-161	• Covers up to 2 ½" hole	2 ½" Dia.	Brass Plated		
DJBF-161-CP			2 ½" Dia.	Chrome Plated		
DJBF-161-PC			2 ½" Dia.	Prime Coat		
DJBF-161-SL			2 ½" Dia.	Silver Coated		
DJBF-178-PC	 BF-178	• Covers up to 1 ½" hole	1 ½" Dia.	Prime Coat		
DJBF-178-SL			1 ½" Dia.	Silver Coated		
DJCP-258-BP	 CP-258	• 2 ½" cylinder plate • Indents at 3 & 9 o'clock prevents collar from shifting on wood or metal • Use with Rim or Mortise cylinders	2 ½" Dia.	Brass Plated		
DJCP-258-SL			2 ½" Dia.	Silver Coated		
DJPDF-161-PC	 PDF-161	• Covers up to 2 ½" hole under rim panic device	2 ½" Hole	Prime Coat		
<b>DOOR PULLS / PUSH / PULL PLATES</b>						
	 19 20	• Round Door Pull • Made from solid bar stock	CTC	Diameter		
DJ15-630			6"	¾"		Satin Stainless Steel
DJ19-630			8"	1"	9" x 3" x 2"	Satin Stainless Steel
DJ20-630	10"	1"	11" x 3" x 2"	Satin Stainless Steel		
	 7016	• Pull Plate	CTC	Pull		
DJ7016-628			8"	¾"	3 ½" x 15"	Aluminum
DJ7016-630	¾"	¾"	3 ½" x 15"	Stainless Steel		
	 7110	• Pull Plate • Pull Dimensions: 6 ½" x 1 ¾" x 1 ⅝"	CTC	Pull		
DJ7110-630			5 ½"	6 ½" x 1 ¾" x 1 ⅝"	4" x 16"	Satin Stainless Steel
	 7114 7116	• Pull Plate	CTC	Pull		
DJ7114-605			5 ½"	¾"	4" x 16"	Bright Brass
DJ7114-628			5 ½"	¾"	4" x 16"	Aluminum
DJ7116-605			8"	¾"	4" x 16"	Polished Brass
DJ7116-628			8"	¾"	4" x 16"	Aluminum
DJ7116-630	8"	¾"	4" x 16"	Stainless Steel		



### DOOR PULLS & PUSH PLATES







Product No.	Product	Description	Dimensions	Finish
<b>OFFSET DOOR PULLS</b>				
DJ1156-313		<ul style="list-style-type: none"> <li>• Dimensions - Overall x Projection x Clearance</li> <li>• Made from solid bar stock</li> <li>• 1156 - CTC = 8" Diameter = 1"</li> <li>• 1157 - CTC = 10" Diameter = 1"</li> <li>• 1160 - CTC = 9" Diameter = 1"</li> </ul>	9" x 3" x 2"	Dark Bronze
DJ1156-628			9" x 3" x 2"	Aluminum
DJ1157-613			11" x 3" x 2"	Dark Bronze
DJ1157-628			11" x 3" x 2"	Aluminum
DJ1157-630			11" x 3" x 2"	Satin Stainless Steel
DJ1160-313			10" x 3" x 2"	Aluminum
DJ1160-628			10" x 3" x 2"	Aluminum
DJ1160-630			10" x 3" x 2"	Satin Stainless Steel
<b>PUSH PLATES</b>				
<b>Temporary Door Pull</b>				
DJ1165-313		12" CENTER-TO-CENTER OR LESS	12" CTC OR LESS	Dark Bronze
DJ1165-628		12" CENTER-TO-CENTER OR LESS	12" CTC OR LESS	Aluminum
DJ70-605		<ul style="list-style-type: none"> <li>• Push Plates</li> <li>• Beveled edges, adhesive mounting, rounded corners, cylinder cut-outs are available</li> </ul>	3 1/2" x 15"	Bright Brass
DJ70-613			3 1/2" x 15"	Dark Bronze
DJ70-628			3 1/2" x 15"	Aluminum
DJ70-630			3 1/2" x 15"	Satin Stainless Steel
DJ71-605		<ul style="list-style-type: none"> <li>• Push Plates</li> <li>• Beveled edges, adhesive mounting, rounded corners, cylinder cut-outs are available</li> </ul>	4" x 16"	Bright Brass
DJ71-612			4" x 16"	Dull Bronze
DJ71-613			4" x 16"	Dark Bronze
DJ71-628			4" x 16"	Aluminum
DJ71-630			4" x 16"	Satin Stainless Steel
DJ72-628		<ul style="list-style-type: none"> <li>• Push Plates</li> <li>• Beveled edges, adhesive mounting, rounded corners, cylinder cut-outs are available</li> </ul>	6" x 16"	Aluminum
DJ1874-630		• Box Packaged 1 1/4" Hole	2" x 3 3/4"	Stainless Steel

### KICK PLATES



Product No.	Product	Description	Dimensions	Finish
<b>KICK PLATES</b>				
DJ10" X 34" 630		<ul style="list-style-type: none"> <li>• Used on doors subject to marring or damage from foot traffic.</li> <li>• Full threaded to the head stainless steel sheet metal screws with plated finish</li> <li>• Beveled 3 or 4 sides optional</li> <li>• Commercial grade thickness</li> <li>• Furnished with grain or satin finish running horizontally to door</li> <li>☐ IP = Individually Packed to be used for any product that is shipped by carrier.</li> </ul>	10" X 34"	Satin Stainless Steel
DJ10" X 34" 630 IP☐			10" X 34"	Satin Stainless Steel

☐ Ask Us About Special Ordering Kick Plates









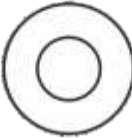

## REMODELER PLATES

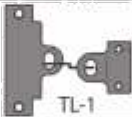
Product No.	Product	Description	Dimensions	Finish
<b>REMODELER PLATES</b>				
DJRP-13509-605	 RP-13509	• Remodeler Plates for modernizing or decorating • Polybagged	3 1/2" x 9"	Bright Brass
DJRP-13509-609			3 1/2" x 9"	Antique Brass
DJRP-13509-630			3 1/2" x 9"	Satin Stainless Steel
DJRP-13509-630-2	 RP-13509-2		3 1/2" x 9"	Satin Stainless Steel
DJRP-13515-605	 RP-13515	• Remodeler Plates for modernizing or decorating • Polybagged	3 1/2" x 15"	Bright Brass
DJRP-13515-630			3 1/2" x 15"	Satin Stainless Steel
DJRP-13515-630-2	 RP-13515-2	• Remodeler Plates for modernizing or decorating • Polybagged	3 1/2" x 15"	Satin Stainless Steel
DJRP-13545-605	 RP-13545	• Remodeler Plates for modernizing or decorating • Polybagged	3 1/2" x 4 1/2"	Bright Brass
DJRP-13545-609			3 1/2" x 4 1/2"	Antique Brass
DJRP-13545-630			3 1/2" x 4 1/2"	Satin Stainless Steel
DJRP-13545-630-2	 RP-13545-2	• Remodeler Plates for modernizing or decorating • Polybagged	3 1/2" x 4 1/2"	Satin Stainless Steel
DJRPK-109-605	 RPK-109	• Remodeler Plates for modernizing or decorating • Kit Contains: (2) RP-13509 (1) CV-86-C & all fasteners	3 1/2" x 9"	Bright Brass
DJRPK-109-630			3 1/2" x 9"	Satin Stainless Steel
DJRP-14-630-2	RP-14-630-2	• Remodeler Plates for modernizing or decorating • Polybagged	5" x 14"	Satin Stainless Steel

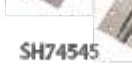
## ACCESSORIES

 <p><b>Door Viewer 180°</b>                      9/16" Hole with Plastic Lens                      DJDV-180-605 Polished Brass                      DJDV-180-626 Dull Chrome</p> <p>7/8" Hole with Plastic Lens                      DJDVC-605                      DJDVC-626</p>		<p><b>Heavy-Duty Crash Chain</b>                      Gray Vinyl Cover                      Dull Chrome, Polybagged</p> <p>DJHDCC-2512-626    25 1/2" in Length                      DJHDCC-3012-626    30 1/2" in Length</p>
<p><b>Door Viewer - Polished Brass</b>                      U.L. Glass Lens</p> <p>DJULDV-180-605    180°    9/16" Hole                      DJULDV-90-605    160°    1/2" Hole                      DJULDV-180-626    180°    9/16" Hole</p>		

**BOLTS & ACCESSORIES**

Product No.	Product	Description	Dimensions	Finish	
<b>BOLTS, HINGES AND ACCESSORY HARDWARE</b>					
DJSP-135-605	 <p>SP-135</p>	<ul style="list-style-type: none"> <li>• SCAR PLATES used to convert 2 3/4" to 2 3/4" backset</li> <li>• Fits under rose of key-in-knob or deadbolt locks</li> <li>• Polybagged</li> </ul>	3 1/2" O.D. x 1/8"	Bright Brass	
DJSP-135-609			3 1/2" O.D. x 1/8"	Antique Brass	
DJSP-135-612			3 1/2" O.D. x 1/8"	Satin Bronze	
DJSP-135-630			3 1/2" O.D. x 1/8"	Satin Stainless Steel	
DJDSP-135-605	 <p>DSP-135</p>	<ul style="list-style-type: none"> <li>• SCAR PLATES used to convert 2 3/4" to 2 3/4" backset</li> <li>• Fits under deadbolt collars</li> <li>• Polybagged</li> </ul>	3 1/2" O.D. x 1 1/2"	Bright Brass	
DJDSP-135-609			3 1/2" O.D. x 1 1/2"	Antique Brass	
			3 1/2" O.D. x 1 1/2"	Satin Bronze	
DJDSP-135-630			3 1/2" O.D. x 1 1/2"	Satin Stainless Steel	
DJ1590-605	 <p>1590</p>	<ul style="list-style-type: none"> <li>• Elbow Catch</li> <li>• Polybagged</li> </ul>	Material: Cast	Bright Brass	
DJ1590-625			Material: Cast	Chrome	
DJ1550-DU	 <p>1550 and 1551</p>	<ul style="list-style-type: none"> <li>• Aluminum Flush Bolt</li> <li>• 7/8" x 4 1/4" Radius Face</li> </ul>	Offset		
DJ1550-SL			1/8"	5/16" x 4 1/4"	Duranodic
DJ1551-DU			1/8"	5/16" x 4 1/4"	Silver
DJ1551-SL			1/4"	5/16" x 4 1/4"	Silver
DJTL-1	 <p>TL-1</p>	<ul style="list-style-type: none"> <li>• Temporary Lock</li> <li>• Replaces ANSI strike and latch with padlock loop.</li> <li>• Fits 2 1/8" Latch preps</li> <li>• Fits 4 3/8" Strike Prep</li> </ul>	---	Prime Coat	
DJBB74540-652	 <p>BB74540 BB74545</p>	<ul style="list-style-type: none"> <li>• Ball Bearing template hinges standard weight</li> <li>• Base Material: Steel</li> </ul>	4 1/2" x 4"	Satin Chrome Plated	
DJBB74545-652			4 1/2" x 4 1/2"	Satin Chrome Plated	
DJSH74545-652			 <p>SH74545</p>	<ul style="list-style-type: none"> <li>• Spring template hinges standard weight</li> <li>• Base Material: Steel</li> </ul>	4 1/2" x 4 1/2"
<b>BOLTS, HINGES AND ACCESSORY HARDWARE</b>					
DJ1555-626		<ul style="list-style-type: none"> <li>• UL Rated</li> <li>• For Metal Doors</li> </ul>	6 3/4" x 1"	Dull Chrome	
DJ1580-626		<ul style="list-style-type: none"> <li>• UL Surface Bolt, Furnished with Rim and Mortise Strikes</li> <li>• Polybagged</li> </ul>	8"	Dull Chrome	
DJSB-3-605		<ul style="list-style-type: none"> <li>• Slide Bolt</li> <li>• Furnished with Rim &amp; Mortise strikes</li> <li>• Polybagged</li> </ul>	3"	Polished Brass	
DJSB-4-605			4"	Polished Brass	
DJSB-4-626			4"	Dull Chrome	
DJ1603-605		<ul style="list-style-type: none"> <li>• Aluminum</li> <li>• Polybagged</li> </ul>	-	Polished Brass	
DJ1607-605		<ul style="list-style-type: none"> <li>• Cast Brass</li> <li>• Polybagged</li> </ul>	-	Polished Brass	



**DOOR STOPS, HOLDERS, BUMPERS**



**DJ1407-630**  
Wrought Wall Bumper  
- Stainless Steel

*Plastic Dry Wall Anchor  
2 1/2" Diameter*



**DJ1411-626**  
Wall Bumper -



**DJ1432-626**  
Door Stop  
Cast Aluminum  
1 3/4" B x 1 3/8" H



**DJ1440-626**  
Floor Stop - Dull  
Chrome  
*Fastener: W/S & MS &  
Exp Shield and Plastic  
Anchor  
3/4" H x 1 3/8" B  
Low Style*



**DJ1441-626**  
Contemporary  
Floor Stop



**DJ1442-626**  
Floor Stop - Dull  
Chrome  
*Fastener: W/S & MS &  
Exp Shield and Plastic  
Anchor  
1/2" H x 1 3/8" B  
High Style*



**DJ1452-626**  
Door Stop  
*Fastener: W/S & Exp.  
Shield  
2 3/4" Projection 2 1/4" x  
1 1/4" Base*



**DJ1453-626**  
Door Stop  
*Fastener: W/S & Exp.  
Shield  
2 3/4" Projection 2 1/4" x  
1 1/4" Base*



**Door Holders**  
*Fastener: SMS Cast  
Iron Sprayed  
4" Projection*  
**DJ1466-AL** Aluminum  
**DJ1466-BZ** Bronze



**DJ1473-626**  
Door Stops  
*Fastener: WS, MS, Exp.  
Shield and Plastic Anchor  
3" Projection  
2 1/4" Base*



**DJ1514-626**  
Door Holder - Dull  
Chrome  
*Projection: 3 1/2"  
Dimensions: 2" x 2 1/4"  
ANSI: L11291*



**DJ1520-626**  
Door Holder - Dull  
Chrome  
*Door to Floor Clearance:  
1/2" or Less  
Holder Dimensions:  
3" W x 3" H  
ANSI: L11301*



**Pull Chain Bolt**  
**DJ1540-CP**



**DJ87-630**  
Protection Bar

DOOR LOCKS



Helps prevent forced entry  
Prevents children from leaving unattended

- DGDG01-AB Door Lock
- DGDG01-B Door Lock
- DGDG01-SC Door Lock
- DGDG01-SN Door Lock
- DGPDG01-W Patto Door Lock



DOOR SCOPE

DOOR SCOPE

WHAT IS DOOR SCOPE?

A revolutionary patented product which virtually eliminates the conventional Peephole. With Door Scope, you don't have to approach the door nor strain to see visitors through the peephole any more, because you receive sharp clear image of the outside visitor up to seven feet away from inside your door.

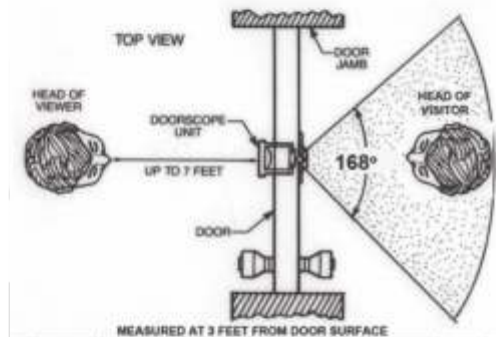
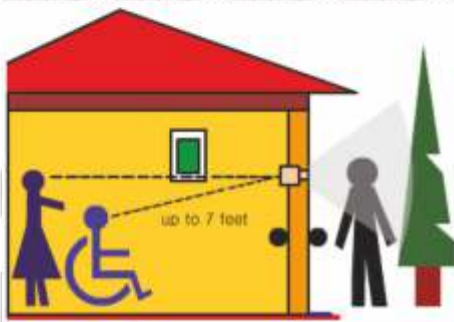

FEATURES

- + Provides 168 degree wide- angle view
- + Viewable from up to 7 feet inside your home
- + Quick, accurate and reliable identification of all visitors
- + Durable and maintenance free
- + Inexpensive
- + Easy installation
- + Available in 36 countries
- + Actual image supposed to be reversed

DSDS/1000-MG	PLASTIC-GREY
DSDS/1000-FB	PLASTIC-BRASS
DSDS/1000-MB	PLASTIC- BLACK
<b>PRODUCT NUMBERS</b> DSDS/2000-ALS	ALUMINUM-SILVER

**PRODUCTS**

ENHA8-LP-PS-BR-39 LOW ENERGY LP PUSH BRZ 39"  
 ENHA8-LP-PS-CL-39 LOW ENERGY LP PUSH CLR 39"  
 ENW5-505B Z-ARM PULL BRONZE LEFT  
 ENW5-505C Z-ARM PULL CLEAR LEFT  
 ENW5-506B Z-ARM PULL BRONZE RIGHT  
 ENW5-506C Z-ARM PULL CLEAR RIGHT  
 ENW5-550 CLEAR PULL TRACK FOR Z-ARMS  
 ENW5-555 BRONZE PULL TRACK FOR Z-ARMS  
 ENW5-670 WAVE-TO-OPEN SWITCH INCLUDES  
 ENW6-147 ENTREMATIC RESTROOM KIT  
 ENW7-130-1 HA8LP LOW ENERGY CONTROL  
 ENW7-200 COMPLETE PUSH ARM CLEAR  
 ENW7-205 COMPLETE PUSH ARM BRONZE

ENW9-200  
 ENW9-205  
 ENW9-210  
 ENW9-215  
 ENW9-220  
 ENW9-225  
 ENW9-230  
 ENW9-235  
 ENWL-P0068  
 ENWL-P0108  
 ENWL-PWRKIT  
 ENWL-ROCKER

EZ36 CLEAR PUSH STANDARD  
 EZ36 CLEAR PULL LEFT HAND  
 EZ36 CLEAR PULL RIGHT HAND  
 EZ36 CLEAR UNIVERSAL ARM  
 EZ36 BRONZE PUSH STANDARD  
 EZ36 BRONZE PULL LEFT HAND  
 EZ36 BRONZE PULL RIGHT HAND  
 EZ36 BRONZE UNIVERSAL ARM  
 LOW PROFILE REED SWITCH  
 HA8-LP EXTENDED SPINDLE SHAFT  
 24VDC 1.1 AMP AUX POWER SUPPLY  
 3-WAY TOGGLE SWITCH



ENHA8-LP-PS-BR-39



ENW5-505B



ENW5-550



ENW5-670



ENW6-147



ENW7-130-1



ENW7-200



ENW9-200



ENW9-220



ENW9-235



ENWL-P0068



ENWL-P0108

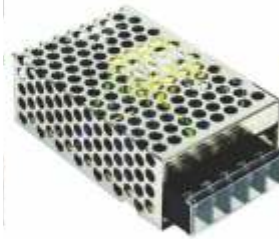

ENWL-PWRKIT



ENWL-ROCKER





Allegion creates peace of mind by pioneering safety and security.

Call or visit us today to speak with one of our experts about the Allegion products we carry and a solution that is right for you.



Locks



Exit devices



Door closers

## We deliver solid solutions.

We know that businesses are built on solutions that exceed expectations. Our selection of Falcon® products deliver solid performance at a solid price. Falcon consistently delivers durability, convenience and unmatched value. For over 40 years, they've built a reputation of providing quality products at a reasonable price. It's also the way we do business and it's why we think Falcon is a solid choice for any project.

**FALCON.**

Falcon is the property of Allegion plc. All other brand names, product names or trademarks are the property of their respective owners.

**ALLEGION™**   
Authorized distributor

010583 © 2016 Allegion

## 24 & 25 SERIES

### 24 Series Narrow Stile Exit Device



**Features**

- Non-handed
- Stainless steel pushpad and latch bolt, 3/4" throw
- 299 Strike
- Grade 1, ANSI A156.3-2001
- Adaptable for all functions and trims
- Does not fit 36" narrow stile door

FA24-R-EO-US28-3      EXIT RIM EO NARROW STILE  
 FA24-R-EO-313AN-3    EXIT RIM EO NARROW STILE

### 25 Series Wide Exit Device



FA25-R-NL-OP-US28-3    EXIT RIM NL LESS TRIM  
 FA25-R-EO-US26D-3    RIM PANIC DEVICE EXIT ONLY  
 FA25-R-EO-US26D-4    RIM PANIC DEVICE EXIT ONLY

### 25 Series Trim



FA510L-NL-US26D    25 Dane Lever Nightlatch  
 FA510L-US26D      25 Dane Lever Lock/Unlock

## 8200 SERIES

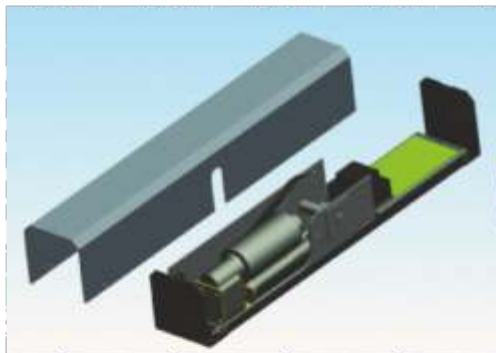

- **SmartLatch** – Senses and overcomes external pressure conditions with a graduated energy assist for secure latching.
- **Push 'n' Go** – Selectable feature allows door to open automatically as soon as it feels pressure.
- **Open Position Learning** – Automatically sets the opening position to eliminate wall and door damage.
- **Obstacle Obstruction Detection** – Safety feature stops and reverses door direction when distress or an obstruction is sensed.
- **Pre-Load Strike Assist** – Removes load on strike lip with a one second delay allowing the door to release and automatically open.
- **LED Light Illumination** – Signals accurate installation and helps with connection diagnostics.
- **On Board Power Supply (12 VAC)**

FA8242-REG-AL    Auto Operator Push Side



PANIC EXIT HARDWARE

Non-Handed Rim Device 19-R Series

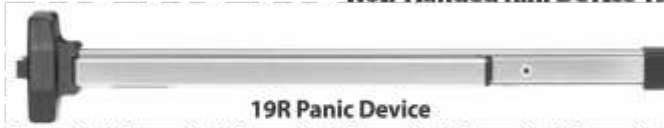

19R Panic Device

- |                   |             |                             |
|-------------------|-------------|-----------------------------|
| FA19-R-EO-SP28-4  | Aluminum    | (Will not fit narrow stile) |
| FA19-R-EO-SP313-4 | Dark Bronze | (Will not fit narrow stile) |
| FA19-R-EO-SP28-3  | Aluminum    |                             |
| FA19-R-EO-SP313-3 | Dark Bronze |                             |

Features:

- Covers a 161 cutout and may be used on 1 1/4" narrow stile aluminum doors
- Strikes: 570 standard
- Latchbolt: Stainless steel, 3/4" throw
- Deadlocking Latchbolt: Standard
- Dogging Feature: 1/2 turn cam dogging standard
- No threaded parts to wear out
- Certified ANSI A156.3-2001 Grade 1 standards



912L  
L-Control Dane

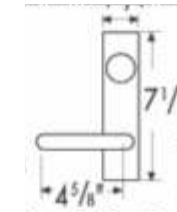

Lever Projection:  
Dane = 27/8"



Head Assembly  
FA650307-00

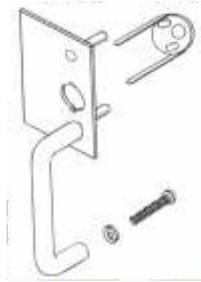

Centron Pull Trim  
PULL(Night Latch)

FA930NL-US32D Aluminum



565

For narrow stile door and removable mullion installations.

FA565-US26D For 19R, 18R, XXR



Hex Dogging Kit

FA185-SP28



FA610480-00 Dogging Sub Assy.



FA650384-00 Chassis Cover

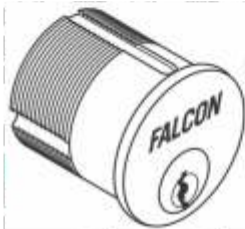

Lock Cylinders

- FA985-6pin-0bit-FalconG-626
- FA985-6pin-0bit-SchlageC-626
- FA986-6pin-0bit-FalconG-626
- FA986-6pin-0bit-SchlageC-626
- FAC987-626
- FA1408

- STANDARD MA LOCK CYLINDER GALA
- STANDARD MA LOCK CYLINDER GALA
- STANDARD MA LOCK CYLINDER NAPA
- STANDARD MA LOCK CYLINDER NAPA
- SFIC HOUSING FOR MA LOCK 626
- SFIC CONST CORE PLASTIC

DEVICE TRIM



Control Trim (Dane)

Key locks or unlocks trim  
Uses 1 1/4" Mortise Cylinder

- FA912L-DANE-SP28-LHR
- FA912L-DANE-SP28-RHR
- FA912L-DANE-SP313-LHR
- FA912L-DANE-SP313-RHR
- FA914KIL-IC-LHR-SP313-DANE
- FA914KIL-IC-LHR-US32D-DANE
- FA914KIL-IC-RHR-SP313-DANE
- FA914KIL-IC-RHR-US32D-DANE
- FA914KIL-KD-LHR-SP313-DANE
- FA914KIL-KD-LHR-US32D-DANE
- FA914KIL-KD-RHR-SP313-DANE
- FA914KIL-KD-RHR-US32D-DANE

Alum

Alum

D. Bronze

D. Bronze

KEY IN LEVER WITH I/C CYLINDER

KEY IN LEVER WITH I/C CYLINDER

KEY IN LEVER WITH I/C CYLINDER

KEY IN LEVER WITH I/C CYLINDER

KEY IN LEVER WITH I/C CYLINDER

KEY IN LEVER WITH KD CYLINDER

KEY IN LEVER WITH KD CYLINDER

KEY IN LEVER WITH KD CYLINDER

## EXIT DEVICES

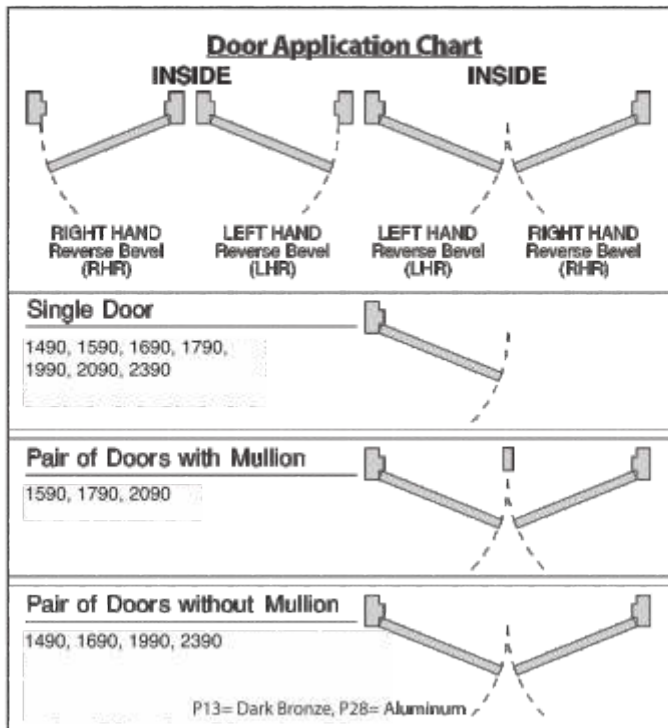

### 1990 Series

The classic look of the 1990 has a long history of reliable performance. It is equipped with hardened steel latches and adjustable strike to ensure safety, security and quiet operation.

- Field reversible, non-handed
- Hex Key dogging standard
- Cylinder: Rim, key entry (NL) or hold back (HB) feature available, field selectable
- Doors: 1 3/4" thick metal doors
- Projections: 4 3/8" extended, 2 1/2" depressed
- Pushbar height is 2 1/2"
- 7' standard vertical rods, extension rods available up to 10'
- Certified ANSI A156.3 Grade 1 std

### 2090 Series

- RHR or LHR, not reversible
- Hex Key dogging standard
- Latchbolt: 1/2" throw hardened steel
- Cylinder: Rim, key entry (NL) or hold back (HB) available, field selectable
- Sizes: Field adjustable width, 41" crossbar standard, fits 3'8" door width, extra length crossbars available
- Doors: 1 3/4" metal or wood door
- Projections: 4 3/8" extended, 2 1/2" depressed
- Certified ANSI A156.3 Grade 1 standard

### 1690 Series

Centercase provides a clear indication of direction of egress and completely covers the existing 1990 to the 1990 device and can work with existing panic frames.

- Field reversible, non-handed
- Hex Key dogging standard, except EL where must use hold back
- Cylinder: Rim, key entry (NL) or hold back (HB) feature available, field selectable
- Doors: 1 3/4" thick metal doors
- Projections: 3 3/8" in neutral, 2 3/8" in dogged position.
- Pushbar height is 2 1/2"
- 7' standard vertical rods, extension rods available up to 10'
- Certified ANSI A156.3 Grade 1 std

### 1790 Series



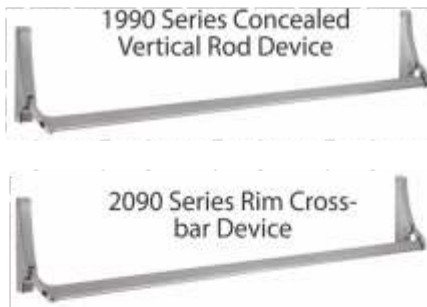

Center case provides a clear indication of direction of egress and completely covers the existing 1990 or 2090 prep.

- Less Rim Cylinder
- Non-handed
- Hex Key dogging standard, except EL where must use hold back feature
- Cylinder: Rim, key entry (NL) or hold back (HB) feature available, field selectable
- Doors: 1 3/4" metal or wood doors
- Projections: 3 3/8" in neutral, 2 3/8" in dogged position.
- Pushbar height is 2 1/2"
- Certified ANSI A156.3 Grade 1 std



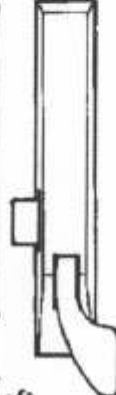

- 1990 SERIES**  
FA1990EO-P13 Exit Device Cvr Type (7') 44" P13 SU HEX PB48, Dark Brz  
FA1990EO-P28 Exit Device Cvr Type (7') 44" P28 SU HEX PB48, Aluminum
- 1690 SERIES**  
FA1692NL-OP-DC13 3' x 7' CVR Exit Device  
FA1692NL-OP-US28 3' x 7' CVR Exit Device
- 1690 SERIES Electric Latch Retraction**  
FAEL1692NL-OP-DC13 3' X 7' ELR CVR EXIT DEVICE  
FAEL1692NL-OP-US28 3' X 7' ELR CVR EXIT DEVICE
- 1790 SERIES**  
FA1792NL/HB-OP-DC13 36" Rim Type Exit Device TD35 Strike  
FA1792NL/HB-OP-US28 36" Rim Type Exit Device TD35 Strike
- 2090 SERIES**  
FA2090EO-LHR-P13 Exit Device Rim Type 44" P13 LHR SD36 Strike  
FA2090EO-LHR-P28 Exit Device Rim Type 44" P28 LHR SD36 Strike  
FA2090EO-RHR-P13 Exit Device Rim Type 44" P13 RHR SD36 Strike  
FA2090EO-RHR-P28 Exit Device Rim Type 44" P28 RHR SD36 Strike

EXIT DEVICES — continued

End Case DCX-2 1990 Series: Both • 2090 Series: Inactive		Active Case DCX-1 • 2090 Series	
			
<b>Left</b>	<b>Right</b>	<b>Left</b>	<b>Right</b>
FA4270902778 (DCX-2)	1990 End Case Left P13	FA4270902742 (DCX-1)	2090 Active Case LH P13
FA4270902776 (DCX-2)	1990 End Case Left P28	FA4270902740 (DCX-1)	2090 Active Case LH P28
FA4270902784 (DCX-2)	1990 End Case Right P13	FA4270902748 (DCX-1)	2090 Active Case RH P13
FA4270902782 (DCX-2)	1990 End Case Right P28	FA4270902746 (DCX-1)	2090 Active Case RH P28

EXIT DEVICE PARTS

FA4270101806 (PB130)	SU Top Latch 990/1990			
FA4270107283 (PB117)	1590 NL Cam Assembly	4270107283 1590 NL CAM (PB117)	4270101806 (PB130)	
FA4270902091 (PBX-2)	1990 Auxiliary PKG US32D	BUSH.109 (PB3)	BUSH.102 (PB10)	BUSH.103 (SD43)
FABUSH.102 (PB10)	Cylinder Bushing	KEY.101 (PB99)	RETRACT.102 (PB64)	SPRING.102 (RD9)
FABUSH.103 (SD43)	Axle Bushing	PB48-P13 PB48-US32D	RETAIN.102 (SD45)	SPRING.103 (SD9)
FABUSH.109 (PB3)	Bearing Bushing White	KEY.101 (PB99)	RETRACT.102 (PB64)	SPRING.102 (RD9)
FACAM.102 (PB5)	Pinion Cam	KEY.101 (PB99)	RETRACT.102 (PB64)	SPRING.103 (SD9)
FAKEY.101 (PB99)	Hex Dogging Key 7/32	KEY.101 (PB99)	RETRACT.102 (PB64)	SPRING.103 (SD9)
FAKEY.10020 (PB232)	Hex Dogging Key 5/32	KEY.101 (PB99)	RETRACT.102 (PB64)	SPRING.103 (SD9)
FAKIT.1197	Dogging Kit 16/17/2390	KEY.101 (PB99)	RETRACT.102 (PB64)	SPRING.103 (SD9)
FAPB48-P13	Top Strike (CVR Devices)	KEY.101 (PB99)	RETRACT.102 (PB64)	SPRING.103 (SD9)
FAPB48-US32D	Top Strike (CVR Devices)	KEY.101 (PB99)	RETRACT.102 (PB64)	SPRING.103 (SD9)
FARETAIN.102 (SD45)	Spring Retainer	KEY.101 (PB99)	RETRACT.102 (PB64)	SPRING.103 (SD9)
FARETRACT.101 (PB35)	1990 Rod Retractor	KEY.101 (PB99)	RETRACT.102 (PB64)	SPRING.103 (SD9)
FARETRACT.102 (PB64)	2090 Latchbolt Retractor	KEY.101 (PB99)	RETRACT.102 (PB64)	SPRING.103 (SD9)
FARRING.109 (PB4)	Retaining Ring .250 Std E	KEY.101 (PB99)	RETRACT.102 (PB64)	SPRING.103 (SD9)
FASCREW.1022 (PB14)	Dog Screw	KEY.101 (PB99)	RETRACT.102 (PB64)	SPRING.103 (SD9)
FASPRING.102 (RD9)	Old Style Tension Spring	KEY.101 (PB99)	RETRACT.102 (PB64)	SPRING.103 (SD9)
FASPRING.103 (SD9)	Tension Spring	KEY.101 (PB99)	RETRACT.102 (PB64)	SPRING.103 (SD9)
FASTUD.101 (PB2)	1990 Case Mounting Stud	KEY.101 (PB99)	RETRACT.102 (PB64)	SPRING.103 (SD9)
FASTUD.102	9970 Pull Mounting Stud	KEY.101 (PB99)	RETRACT.102 (PB64)	SPRING.103 (SD9)





**MISC. LOCKS**



**W511**



**T511**

- FAT381BD-DAN-626
- FAT381CP6D-DAN-626
- FAT511BD-DAN-626
- FAT511CP6D-DAN-626
- FAT511LD-DAN-626
- FAT561BD-DAN-626
- FAT561CP6D-DAN-626
- FAT581BD-DAN-626
- FAT581CP6D-DAN-626
- FAW101S-DAN-613
- FAW101S-DAN-626
- FAW301S-DAN-613
- FAW301S-DAN-626
- FAW511CP6D-DAN-613
- FAW511CP6D-DAN-626
- FAW561CP6D-DAN-613
- FAW561CP6D-DAN-626
- FAW581CP6D-DAN-613
- FAW581CP6D-DAN-626

- CLASS SEC LOCK DANE GRADE 1
- CLASS SEC LOCK DANE GRADE 1
- ENTRY/OFFICE LOCK DANE GRADE 1
- ENTRY/OFFICE LOCK DANE GRADE 1
- ENTRY/OFFICE LOCK DANE GRADE 1
- CLASSROOM LOCK DANE GRADE 1
- CLASSROOM LOCK DANE GRADE 1
- CLASSROOM LOCK DANE GRADE 1
- STOREROOM LOCK DANE GRADE 1
- STOREROOM LOCK DANE GRADE 1
- PASSAGE LOCK DANE GRADE 2
- PASSAGE LOCK DANE GRADE 2
- PRIVACY LOCK DANE GRADE 2
- PRIVACY LOCK DANE GRADE 2
- ENTRY/OFFICE LOCK DANE GRADE 2
- ENTRY/OFFICE LOCK DANE GRADE 2
- CLASSROOM LOCK DANE GRADE 2
- CLASSROOM LOCK DANE GRADE 2
- STOREROOM LOCK DANE GRADE 2
- STOREROOM LOCK DANE GRADE 2



**Grade 1**

- FAK101S-DAN-626
- FAK301S-DAN-626
- FAK511BD-DAN-626
- FAK511CP6D-DAN-626
- FAK561BD-DAN-626
- FAK561CP6D-DAN-626
- FAK581BD-DAN-626
- FAK581CP6D-DAN-626
- FAT101S-DAN-626
- FAT301S-DAN-626

- PASSAGE LOCK DANE GRADE 1
- PRIVACY LOCK DANE GRADE 1
- ENTRY/OFFICE LOCK DANE GRADE 1
- ENTRY/OFFICE LOCK DANE GRADE 1
- CLASSROOM LOCK DANE GRADE 1
- CLASSROOM LOCK DANE GRADE 1
- STOREROOM LOCK DANE GRADE 1
- STOREROOM LOCK DANE GRADE 1
- PASSAGE LOCK DANE GRADE 1
- PRIVACY LOCK DANE GRADE 1



**Grade 2**

- FAA30730-001-00
- FAB101S-DAN-626
- FAB301S-DAN-626
- FAB511BD-DAN-626
- FAB511CP6D-DAN-626
- FAB561BD-DAN-626
- FAB561CP6D-DAN-626
- FAB581BD-DAN-626
- FAB581CP6D-DAN-626

- PKG OF 10 TAILPIECES FOR
- PASSAGE LOCK DANE GRADE 2
- PRIVACY LOCK DANE GRADE 2
- ENTRY/OFFICE LOCK DANE GRADE 2
- ENTRY/OFFICE LOCK DANE GRADE 2
- CLASSROOM LOCK DANE GRADE 2
- CLASSROOM LOCK DANE GRADE 2
- STOREROOM LOCK DANE GRADE 2
- STOREROOM LOCK DANE GRADE 2



**DG**

Napa escutcheon (N)

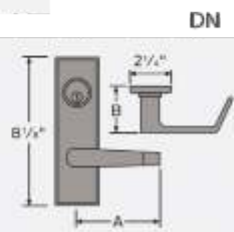

**Mortise Locks**

- FAMA101-DG-626
- FAMA101-DN-626
- FAMA301-DG-626
- FAMA301-DN-626
- FAMA521L-DG-626
- FAMA521L-DN-626
- FAMA531L-DG-626
- FAMA531L-DN-626
- FAMA571L-DG-626
- FAMA571L-DN-626
- FAMA581L-DG-626
- FAMA581L-DN-626

- MORTISE PASSAGE GRADE 1
- MORTISE PASSAGE GRADE 1
- MORTISE PRIVACY GRADE 1
- MORTISE PRIVACY GRADE 1
- MORTISE ENTRY G1 LESS CYLINDER
- MORTISE ENTRY G1 LESS CYLINDER
- MORTISE APARTMENT G1 LESS CYL
- MORTISE APARTMENT G1 LESS CYL
- MORTISE DORMITORY G1 LESS CYL
- MORTISE DORMITORY G1 LESS CYL
- MORTISE STOREROOM G1 LESS CYL
- MORTISE STOREROOM G1 LESS CYL



**300 SERIES ELECTRIC STRIKES**

**310-2**



- For mortise locks or mortise exit devices having 1/2" or 3/4" throw latchbolt (without deadbolts)
- Constructed entirely of stainless steel
- Horizontally adjustable keeper to allow for door and frame misalignment
- 1/2" keeper depth
- Non-Fail Safe (standard)

FG310-2-12D-630  
FG310-2-24D-630

**310-4**



- For rim exit devices or the top latch of a surface vertical rod exit device
- Constructed entirely of stainless steel
- Horizontally adjustable keeper to allow for door and frame misalignment
- Pullman keeper
- Non-Fail Safe (standard)

FG310-4-12D-630  
FG310-4-24D-630

**700 SERIES ELECTRIC STRIKES**

**712-75**



- For use with locks having 1/2" to 3/4" throw latchbolts (hollow-metal door frames)
- Constructed entirely of stainless steel
- Horizontally adjustable keeper to allow for door and frame misalignment
- 3/4" keeper depth
- Fits Standard ANSI
- A115.1 Frame Cutout (With slight modification to the face of door frame)
- The 712 has square corner faceplate
- Non-Fail Safe (standard)
- BHMA standard 501, Grade 1 electric strike

FG712-75-24D-630

**712 & 732**



- For mortise locks or mortise exit devices having 1/2" or 3/4" throw latchbolt
- Constructed entirely of stainless steel
- Horizontally adjustable keeper to allow for door and frame misalignment
- 1/2" (13mm) keeper depth
- Non-Fail Safe (standard)
- The 712 & 732 have square corner faceplate; but the 732 comes with an offset solenoid for wood frames.

FG712-12D-630  
FG712-24D-630  
FG732-24D-630

**SOLENOIDS**

**300 Series (Non Fail Safe)**

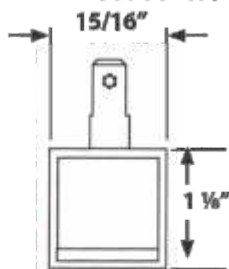

FG076-0122-003  
24v DC

**700 Series (Non Fail Safe)**



**SOLENOID ASSEMBLY**  
1 7/8"  
**PULL TYPE**

FG076-0107-004

**PARTS**

**300 Series Parts**



FG003-0203-001 Latchbolt Keeper Spring (310 Series)



FG003-0210-001 Cam Spring Locking Fall Safe

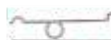

FG003-0211-001 Cam Spring Locking Non-Fail Safe



FG011-0404-001 Lever Spacer Locking



FG011-0405-001 Cam Spacer Locking

**700 Series Parts**



FG003-0007-001 Lever Spring-Locking (700 and 300 Series)



FG003-0202-001 Cam Spring-Locking (700 and 73)



## FULL DOOR INTERLOCKING LATCH PROTECTORS



*Designed for both out-swing and in-swing doors, the patented interlocking system makes it virtually impossible to pry open a door that the product is installed on. Constructed of both aluminum and steel and available in several standard colours the latch protectors are easy to install and are built to last.*

*Steel are "U" shaped, Aluminum are square shaped.*



### Hardware Kits For Out-Swing

FDHDW-B Hardware Kit for Outswing

FDHDW-N Hardware Kit for Outswing

### For Out-Swing Doors

FD1001	ANODIZED ALUMINUM	2 3/8" X 82"
FD1002	ALUMINUM POWDER COATED WHITE	2 3/8" X 82"
FD1003	ALUMINUM P.C. BROWN	2 3/8" X 82"
FD1004	ALUMINUM POWDER COATED BLACK	2 3/8" X 82"
FD2001	STEEL POWDER COATED SILVER	1 7/8" X 82"
FD2003	STEEL P.C. BROWN	1 7/8" X 82"
FD2004	STEEL POWDER COATED BLACK	1 7/8" X 82"
FD2101	STEEL P.C. SILVER	2 3/8" X 82"
FD2103	STEEL POWDER COATED BROWN	2 3/8" X 82"

### For In-Swing Doors

FD3001	ANODIZED ALUMINUM	1 1/2" X 82"
FD3002	ALUMINUM POWDER COATED WHITE	1 1/2" X 82"

### Interlocking Latch Protectors

FDSP1003-95	ALUMINUM PC BROWN	2 3/8" x 95"
FDSP1001-95	ANODIZED ALUMINUM	2 3/8" x 95"
FDSP1004-95	ALUMINUM PC BLACK	2 3/8" x 95"
FDSP2101-108	STEEL PC SILVER	2 3/8" x 108"

Ask about MX Alpha restricted keyway program **NEW!**



**Made to OEM specifications • All the top selling keyways • Unsurpassed quality**

[WWW.GMSLOCK.COM](http://WWW.GMSLOCK.COM) • 888-774-5625

**A PERFECT FIT**

**ONLY ONE** cabinet lock manufacturer provides all these solutions

Olympus Lock manufactures easily rekeyable pin tumbler cabinet locks and interchangeable core cabinet lock bodies for a wide range of commercial and institutional applications such as K-12 schools, universities, health care facilities, banks and more.

Since our very first "easily rekeyable" cabinet lock, we've been providing innovative, keyway compatible cabinet lock solutions to major institutions for more than 30 years.



**N SERIES**  
National Keyway

**R SERIES**  
CCL R1 Keyway

**SCHLAGE**  
Key-in-knob  
Interchangeable Core

**SARGENT**  
Key-in knob  
Interchangeable Core

**PADLOCKABLE**  
Cam Lock

**SMALL FORMAT**  
Interchangeable Core

**CORBIN RUSSWIN**  
Interchangeable Core

**MEDECO**  
Key-in-knob  
Interchangeable Core

**YALE**  
Interchangeable Core



✓ value ✓ quality ✓ fast shipping ✓ huge inventories

## LFIC MORTISE HOUSING

GMICS-10B-SL LFIC MORTISE HOUSING  
GMICS-26D-SL LFIC MORTISE HOUSING



## LFIC RIM HOUSING

GMICSR-10B SCHLAGE LFIC RIM HOUSING  
GMICSR-26D SCHLAGE LFIC RIM HOUSING



## LFIC CORES

GMLFIC-G23-26D-0BNK 123 NO KEYS  
GMLFIC-SC-26D-0B C KEYWAY  
GMLFIC-SCE-26D-0B E KEYWAY  
GMLFIC-G45-26D-0BNK LFIC SCH 145 NO KEYS



## MX3 KEY BLANKS

GMKB5MX3 GMS MX3 KEY BLANK 5-PIN BRASS  
GMKB6MX3 GMS MX3 KEY BLANK 6-PIN BRASS

GMKB7-MXA04-50 MXA04 KEY BLANKS 7-PIN 50 PACK  
GMKBLF-MXA04-5 MXA04 LFIC CONTROL 5 PACK

## MX SERIES

### MX CODE CARD

GMCARD1-MXA HPC CODE CARD FOR MX ALPHA

### PIN KIT

GMKIT-PINMXA PINNING KIT FOR MX ALPHA

### MX IC CORE

GMIC7-MXA04-26D-NK GMS SMALL FORMAT IC CORE 7-PIN  
GMLFIC-MXA04-26D-NK LARGE FORMAT IC CORE

### MX KNOB LEVER CYLINDER

GMK001-MXA04-26D-NK KNOB/LEVER CYLINDER

### MX MORTISE CYLINDER

GMM118-MXA04-10B-AT-NK 1 3/8" MORTISE CYLINDER  
GMM118-MXA04-26D-AT-NK 1 3/8" MORTISE CYLINDER

### MX RIM CYLINDER

GMR118-MXA04-10B-NK RIM CYLINDER  
GMR118-MXA04-26D-NK RIM CYLINDER



## SFIC CORES

### SMALL FORMAT IC CORE 6-PIN

GMIC-6-A-26D  
 GMIC-6-D-26D  
 GMIC-6-E-26D  
 GMIC-6-F-26D  
 GMIC-6-G-26D  
 GMIC-6-H-26D  
 GMIC-6-J-26D  
 GMIC-6-K-26D  
 GMIC-6-L-26D  
 GMIC-6-M-26D

### SMALL FORMAT IC CORE 7-PIN

GMIC-7-A-26D  
 GMIC-7-D-26D  
 GMIC-7-E-26D  
 GMIC-7-F-26D  
 GMIC-7-G-26D  
 GMIC-7-H-26D  
 GMIC-7-J-26D  
 GMIC-7-K-26D  
 GMIC-7-L-26D  
 GMIC-7-M-26D  
 GMIC7-MZA04-26D-NK



## SFIC MORTISE HOUSING

### SMALL FORMAT IC MORTISE HOUSING

GMICM-6-10B-AR	6-PIN AR CAM
GMICM-6-10B-ST	6-PIN STANDARD CAM
GMICM-6-26D-AR	6-PIN AR CAM
GMICM-6-26D-SL	6-PIN SCHLAGE L CAM
GMICM-6-26D-ST	6-PIN STANDARD CAM
GMICM-7-10B-AR	7-PIN STANDARD CAM
GMICM-7-10B-CL	7-PIN CLOVERLEAF CAM
GMICM-7-10B-SA	7-PIN SARGENT CAM
GMICM-7-10B-SL	7-PIN SCHLAGE L CAM
GMICM-7-10B-ST	7-PIN STANDARD CAM
GMICM-7-26D-AR	7-PIN ADAMS RITE CAM
GMICM-7-26D-CL	7-PIN CLOVERLEAF CAM
GMICM-7-26D-SA	7-PIN SARGENT CAM
GMICM-7-26D-SL	7-PIN SCHLAGE L CAM
GMICM-7-26D-ST	7-PIN STANDARD CAM



### SMALL FORMAT IC MORTISE TAPERED HOUSING



GMICT-7-10B-AR  
 GMICT-7-26D-AR

SFIC MORTISE TAPERED HOUSING  
 SFIC MORTISE TAPERED HOUSING

## SFIC RIM HOUSING

### SMALL FORMAT IC RIM HOUSING

GMICR-6-10B 6-PIN  
 GMICR-6-26D 6-PIN  
 GMICR-7-10B 7-PIN  
 GMICR-7-26D 7-PIN



## RIM CYLINDERS

**Features:**

- Exact pinning specifications as original systems
- Solid brass construction
- 16 keyways
- Tailpiece converts between horizontal & vertical positions
- Screw-on retaining cap design

Model	Description	Keyway	Finish <sup>2</sup>	Keying <sup>2</sup>
R118	1 ½" Length, 5 Pin Drilled 6 <sup>1</sup>	16 Keyways Available	3 10B 26D	A2 KA PAIRS
<b>EXAMPLE: GMR118-SC-26D-A2</b>				
<sup>1</sup> 6-Pin for CL4 • RD1 • RA • SA • SAX • SCE • SCF • & YGA Keyways				
<sup>2</sup> Stock configurations shown.				



RIM CYLINDER

FRONT VIEW



BACK VIEW



SIDE VIEW



KEYWAY	Finish: 10B	Finish: 26D	Finish: 3
AW Arrow	GMR118-AW-10B-A2	GMR118-AW-26D-A2	
CB Corbin 60	GMR118-CB-10B-A2	GMR118-CB-26D-A2	
CL4 Corbin L4	GMR118-CL4-10B-A2	GMR118-CL4-26D-A2	
KW Kwikset	GMR118-KW-10B-A2	GMR118-KW-26D-A2	GMR118-KW-3-A2
RD1 Russwin D1	GMR118-RD1-10B-A2	GMR118-RD1-26D-A2	
SA Sargent LA	GMR118-SA-10B-A2	GMR118-SA-26D-A2	
SAX Sargent LA-LD	GMR118-SAX-10B-A2	GMR118-SAX-26D-A2	
RA Sargent RA		GMR118-RA-26D-A2	
SC Schlage C123	GMR118-G23-10B-OBNK-6	GMR118-G23-26D-OBNK-6 GMR118-G45-26D-OBNK-6	
SC Schlage C	GMR118-SC-10B-A2	GMR118-SC-26D-A2	GMR118-SC-3-A2
SCE Schlage E	GMR118-SCE-10B-A2	GMR118-SCE-26D-A2	GMR118-SCE-3-A2
SCF Schlage F	GMR118-SCF-10B-A2	GMR118-SCF-26D-A2	
SX Schlage C-K	GMR118-SX-10B-A2	GMR118-SX-26D-A2	
WR Weiser E	GMR118-WR-10B-A2	GMR118-WR-26D-A2	GMR118-WR-3-A2
YA Yale 8	GMR118-YA-10B-A2	GMR118-YA-26D-A2	GMR118-YA-3-A2
YGA Yale GA	GMR118-YGA-10B-A2	GMR118-YGA-26D-A2	

## MORTISE DUMMY CYLINDERS

3 Lengths

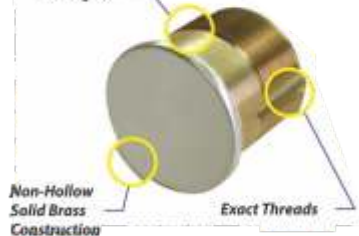

Non-Hollow Solid Brass Construction

Exact Threads

DUMMY CYLINDER

Model	Description
M100D	1" Length
M118D	1 ½" Length
M114D	1 ¾" Length
<b>EXAMPLE: GMM100D-10B</b>	



FRONT VIEW



SIDE VIEW



BACK VIEW

**Features:**

- Non-hollow solid brass construction
- Popular lengths
- Exact threads

GMM100D-10B  
GMM100D-26D  
GMM100D-3  
GMM118D-10B  
GMM118D-26  
GMM118D-26D  
GMM118D-3  
GMM114D-10B  
GMM114D-26D

## MORTISE CYLINDERS

**Features:**

- Exact pinning specifications as original systems
- Solid brass construction
- 16 keyways
- 4 popular lengths



Model	Description	Keyway	Finish <sup>3</sup>	Cam <sup>3</sup>	Keying <sup>3</sup>
M156	1 5/16" Length, 5 Pin Only	16 Keyways Available	3 10B 26D	AR	A2 KA PAIRS
M100	1" Length, 5 Pin Only			AR	
M118	1 1/8" Length, 5 Pin Drilled 6 <sup>1</sup>			ST <sup>2</sup>	
M114	1 1/4" Length, 5 Pin Drilled 6 <sup>2</sup>			ST	

**EXAMPLE: GMM118-SC-26D-ST-A2**

<sup>1</sup> 6-Pin for CL4 • RD1 • RA • SA • SAX • SCE • SCF • & YGA Keyways

<sup>2</sup> Additional AR cam included at no charge

<sup>3</sup> Stock configurations shown.

KEYWAY	M156	M100	M118	M114
AW Arrow			GMM118-AW-10B-ST-A2 GMM118-AW-26D-ST-A2	
ASV Assa V-10			GMM118-ASV-10B-ATNK-6 GMM118-ASV-26D-ATNK-6	
CB Corbin 60		GMM100-CB-10B-AR-A2 GMM100-CB-26D-AR-A2	GMM118-CB-10B-ST-A2 GMM118-CB-26D-ST-A2	GMM114-CB-26D-ST-A2
CL4 Corbin L4			GMM118-CL4-10B-ST-A2 GMM118-CL4-26D-ST-A2	GMM114-CL4-10B-ST-A2 GMM114-CL4-26D-ST-A2
KW Kwikset		GMM100-KW-10B-AR-A2 GMM100-KW-26D-AR-A2	GMM118-KW-10B-ST-A2 GMM118-KW-26D-ST-A2 GMM118-KW-3-ST-A2	GMM114-KW-26D-ST-A2 GMM114-KW-3-ST-A2
RD1 Russwin D1			GMM118-RD1-10B-ST-A2 GMM118-RD1-26D-ST-A2	GMM114-RD1-10B-ST-A2 GMM114-RD1-26D-ST-A2
SA Sargent LA			GMM118-SA-10B-ST-A2 GMM118-SA-26D-ST-A2	GMM114-SA-26D-ST-A2
SAX Sargent LA-LD			GMM118-SAX-10B-ST-A2 GMM118-SAX-26D-ST-A2	
RA Sargent RA			GMM118-RA-10B-ST-A2 GMM118-RA-26D-ST-A2	
SC Schlage C123			GMM118-G23-26D-AT-0B6 GMM118-G45-26D-AT-0B6 GMM118-G23-10B-AT-0B6	
SC Schlage C	GMM156-SC-10B-AR-A2 GMM156-SC-26D-AR-A2	GMM100-SC-10B-AR-A2 GMM100-SC-26D-AR-A2 GMM100-SC-3-AR-A2	GMM118-SC-10B-ST-A2 GMM118-SC-26D-ST-A2 GMM118-SC-3-ST-A2	GMM114-SC-10B-ST-A2 GMM114-SC-26D-ST-A2 GMM114-SC-3-ST-A2
SCE Schlage E			GMM118-SCE-10B-ST-A2 GMM118-SCE-26D-ST-A2 GMM118-SCE-3-ST-A2	GMM114-SCE-10B-ST-A2 GMM114-SCE-26D-ST-A2
SCF Schlage F			GMM118-SCF-10B-ST-A2 GMM118-SCF-26D-ST-A2	
SX Schlage C-K		GMM100-SX-10B-AR-A2 GMM100-SX-26D-AR-A2	GMM118-SX-10B-ST-A2 GMM118-SX-26D-ST-A2	
WR Weiser E	GMM156-WR-10B-AR-A2 GMM156-WR-26D-AR-A2	GMM100-WR-10B-AR-A2 GMM100-WR-26D-AR-A2 GMM100-WR-3-AR-A2	GMM118-WR-10B-ST-A2 GMM118-WR-26D-ST-A2 GMM118-WR-3-ST-A2	GMM114-WR-10B-ST-A2 GMM114-WR-26D-ST-A2 GMM114-WR-3-ST-A2
YA Yale 8	GMM156-YA-26D-AR-A2	GMM100-YA-10B-AR-A2 GMM100-YA-26D-AR-A2 GMM100-YA-3-AR-A2	GMM118-YA-10B-ST-A2 GMM118-YA-26D-ST-A2 GMM118-YA-3-ST-A2	GMM114-YA-10B-ST-A2 GMM114-YA-26D-ST-A2 GMM114-YA-3-ST-A2
YGA Yale GA			GMM118-YGA-10B-ST-A2 GMM118-YGA-26D-ST-A2	GMM114-YGA-10B-ST-A2 GMM114-YGA-26D-ST-A2



## MORTISE T-TURN CYLINDERS

**Features:**

- Solid brass or die-cast turn piece
- Solid brass housing
- 4 popular lengths

GMM100T-10B-AR	MORTISE-T-TURN CYL 1"
GMM100T-26D-AR	MORTISE-T-TURN CYL 1"
GMM100T-3-AR	MORTISE-T-TURN CYL 1"
GMM114T-10B-AR	MORTISE T-TURN CYL 1 1/4"
GMM114T-26D-AR	MORTISE T-TURN CYL 1 1/4"
GMM114T-3-AR	MORTISE T-TURN CYL 1 1/4"
GMM118T-10B-AR	MORTISE T-TURN CYL 1 1/2"
GMM118T-26D-AR	MORTISE T-TURN CYL 1 1/2"
GMM118T-26-ST	MORTISE T-TURN CYL 1 1/2"
GMM118T-3-AR	MORTISE T-TURN CYL 1 1/2"
GMM156T-10B-AR	MORTISE T-TURN CYL 15/16"
GMM156T-26D-AR	MORTISE T-TURN CYL 15/16"

Model	Description
M118T	1 1/2" Length, Solid Brass Turn Piece
M114T	1 1/4" Length, Solid Brass Turn Piece
M100T	1" Length, Solid Brass Turn Piece
M156T	15/16" Length, Solid Brass Turn Piece
<b>EXAMPLE: GMM118T-26D-AR</b>	



## ADA T-TURN CYLINDERS

**Features:**

- Easy no grip operation
- Available in 1", 1 1/8" and 1 1/4"
- Available in 26D, 10B and 3 Finish

GMM100TA-10B-AR
GMM100TA-26D-AR
GMM100TA-3-AR
GMM118TA-10B-AR
GMM118TA-26D-AR
GMM118TA-3-AR
GMM114TA-10B-AR
GMM114TA-26D-AR



Model	Description
M100TA	1" Length, Solid Brass ADA Turn Piece
M114TA	1 1/4" Length, Solid Brass ADA Turn Piece
M118TA	1 1/2" Length, Solid Brass ADA Turn Piece
<b>EXAMPLE: GMM100TA-10B-AR</b>	

## KIK CYL SCHLAGE MODULAR SYSTEM

GMK004-G23-26D-NK-6	KIK CYL SCHLAGE MODULAR SYSTEM	6 PIN 0-BITTED NO KEY BLANKS
GMK004-G45-26D-NK-6	KIK CYL SCHLAGE MODULAR SYSTEM	6 PIN 0-BITTED NO KEY BLANKS
GMK004-SC-26D-0B	KIK CYL SCHLAGE MODULAR SYSTEM	5-PIN DRILLED 6
GMK004-SCE-26D-0B	KIK CYL SCHLAGE MODULAR SYSTEM	5-PIN DRILLED 6



## KITS

GMKIT-PART01	MORTISE CYLINDER CAM KIT
GMKIT-PART02	SFIC & LFIC HOUSING CAM KITS
GMKIT-PART03	RIM CYLINDER PARTS KIT
GMKIT-PART04	COLLAR KIT
GMK001-HSKIT	KNOB CYL HOUSING KIT
GMKIT-K001YA	YALE CONVERSION KIT (K001)



### RIM DUMMY CYLINDERS

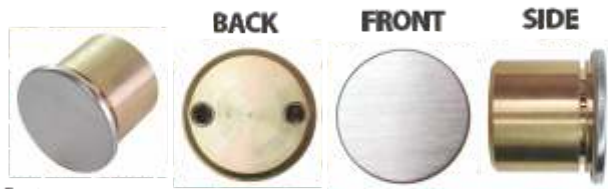

- Features:**
- Non-hollow solid brass housing
  - Furnished with collar, mounting plate & screws

Model	Description	Finish
R118D	1 1/2" Length-with collar, mounting plate & screws	3 10B 26D
<b>EXAMPLE: GMDBM-S-10B-F-2</b>		

- GMR118D-10B
- GMR118D-26D
- GMR118D-3

### PROFILE CYLINDERS



- Features:**
- Solid Brass
  - 5 pin, easy rekeying

- |                  |             |
|------------------|-------------|
| GMPR11-SC-4-KD   | SCH DBL CYL |
| GMPR11-SC-26D-KD | SCH DBL CYL |
| GMPR12-KW-4-KD   | KWI T-TURN  |
| GMPR12-SC-4-KD   | SCH T-TURN  |
| GMPR12-SC-26D-KD | SCH T-TURN  |

### KNOB / LEVER CYLINDER

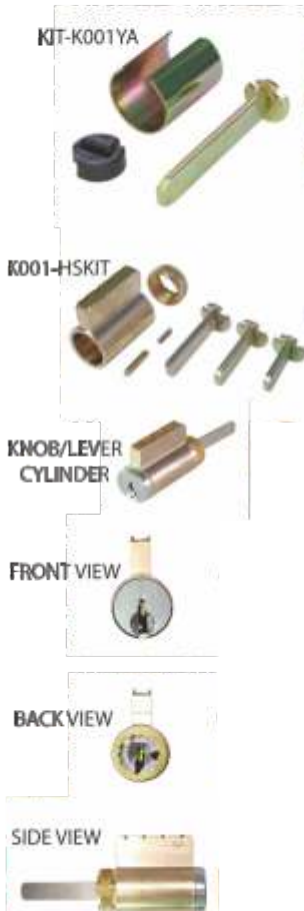

Model	Description	Keyway	Finish
K001	Fits Schlage knobs, levers, deadbolts, 5 pin drilled 6 <sup>2</sup> , 5 tailpieces	14 Keyways Available	4 26D
<b>EXAMPLE: GMK001-AW-26D-0B</b>			
<sup>1</sup> Converts to fit Yale levers with KIT-K001YA Part No. <b>GMKIT-K001YA</b>			
<sup>2</sup> 6 pin only for CL4, RD1, RA, SA, SAX, SCE, SCF & YGA keyways			

- Features:**
- Exact pinning specifications as original systems
  - Solid brass construction
  - 14 keyways
  - Supplied with multiple tailpieces
  - Screw-on retaining cap design

KEYWAY		Finish: 26D	Finish: 4
AW	Arrow	GMK001-AW-26D-0B	
CB	Corbin 60	GMK001-CB-26D-0B	
CL4	Corbin L4	GMK001-CL4-26D-0B	
KW	Kwikset	GMK001-KW-26D-0B	
RD1	Russwin D1	GMK001-RD1-26D-0B	
SA	Sargent LA	GMK001-SA-26D-0B	
SAX	Sargent LA-LD	GMK001-SAX-26D-0B	
SC	Schlage C123	GMK001-G23-26D-0Bnk-6	GMK001-G23-4-0Bnk-6
SC	Schlage C	GMK001-SC-26D-0B	GMK001-SC-4-0B
SC	Schlage 145	GMK001-G45-26D-0Bnk-6	
SCE	Schlage E	GMK001-SCE-26D-0B	GMK001-SCE-4-0B
SX	Schlage C-K	GMK001-SX-26D-0B	
WR	Weiser E	GMK001-WR-26D-0B	GMK001-WR-4-0B
YA	Yale 8	GMK001-YA-26D-0B	GMK001-YA-4-0B
YGA	Yale GA	GMK001-YGA-26D-0B	



**ACCESSORIES & PARTS**

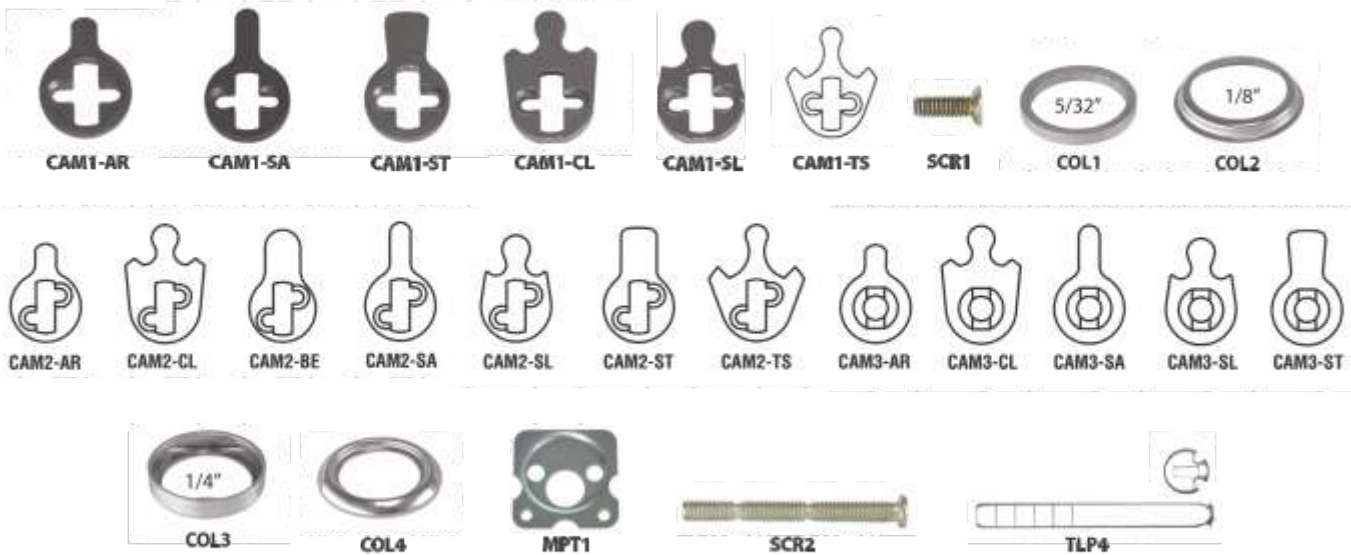

**MORTISE CYLINDERS**

GMCAM1-AR	Adams Rite Cam
GMCAM1-CL	Corbin Cloverleaf Cam
GMCAM1-SA	Sargent Cam
GMCAM1-ST	Schlage L Cam
GMCAM1-SL	Yale Standard Cam
GMCAM1-TS	Falcon/Salok
GMCAM2-AR	Adams Rite
GMCAM2-BE	Best
GMCAM2-CL	Cloverleaf
GMCAM2-SA	Sargent
GMCAM2-SL	Schlage L
GMCAM2-ST	Standard
GMCAM2-TS	Falcon/Salok
GMCAM3-AR	ICS Cam Adams Rite
GMCAM3-CL	ICS Cam Corbin
GMCAM3-SA	ICS Cam Sargent
GMCAM3-SL	ICS Cam Schlage
GMCAM3-ST	ICS Cam Yale
GMCAM4-AR	Assa AST/ASV Std
GMCAM4-ST	Assa AST/ASV AR
GMCAM4-CL	Assa AST/ASV & Schlage G23

GMCAM4-SA	Assa AST/ASV & Schlage G23
GMCAM4-SL	Assa AST/ASV & Schlage G23
GMCAM4-TS	Assa AST/ASV & Schlage G23
GMCAM5-AR-10	Adams Rite 10/Pkg
GMCAM5-CL-10	Cloverleaf 10/Pkg
GMCAM5-SA-10	Sargent 10/Pkg
GMCAM5-SL-10	Schlage 10/Pkg
GMCAM5-ST-10	Yale STD 10/Pkg
GMCAM5-TS-10	Falcon/Salok 10/Pkg
GMSCR1	Cam Screws
GMCOL2-10B	1/8" Trim Ring
GMCOL2-26D	1/8" Trim Ring
GMCOL2-3	1/8" Trim Ring
GMCOL3-10B	1/4" Adjustable Collar
GMCOL3-26D	1/4" Adjustable Collar
GMCOL3-3	1/4" Adjustable Collar
GMIC-SPI	IC Housing Spacer 10/pack
GMSCR2	Mounting Screws 10/bag
GMSCR5	ICS CAM3 Screw
GMSPR5	Cyl Spring Washer 10/pack
GMTLP4	Tailpiece with Fixed 10/bag Motion Driver
GMTLP9	ICSR Tailpiece

**CAPPING BLOCK**

GMCB-01	Capping Block w/Punch
---------	-----------------------

**RIM CYLINDERS**

GMCOL4-10B	Cylinder Collar 10/bag
GMCOL4-26D	Cylinder Collar 10/bag
GMCOL4-3	Cylinder Collar 10/bag
GMCOL6-10B	Tapered Collar w/ Spring
GMCOL6-26D	Tapered Collar w/ Spring
GMCOL6-3	Tapered Collar w/ Spring

**BLOCKING COLLARS**

GMCOL10-10B	1/8" 10 PACK
GMCOL10-26D	1/8" 10 PACK
GMCOL11-10B	1/4" 10 PACK
GMCOL11-26D	1/4" 10 PACK
GMCOL12-10B	3/8" 10 PACK
GMCOL12-26D	3/8" 10 PACK
GMCOL13-10B	1/2" 10 PACK
GMCOL13-26D	1/2" 10 PACK

**TOP AND BOTTOM PINS**

GMS-0B-NP1	Bottom Pin Nickel Silver .181	GMS-6B-NP1	Bottom Pin Nickel Silver .256
GMS-1B-NP1	Bottom Pin Nickel Silver .193	GMS-7B-NP1	Bottom Pin Nickel Silver .268
GMS-2B-NP1	Bottom Pin Nickel Silver .206	GMS-8B-NP1	Bottom Pin Nickel Silver .281
GMS-3B-NP1	Bottom Pin Nickel Silver .218	GMS-9B-NP1	Bottom Pin Nickel Silver .293
GMS-4B-NP1	Bottom Pin Nickel Silver .231	GMS-TL-P1	Top Pin Long .217 Brass 100PK
GMS-5B-NP1	Bottom Pin Nickel Silver .243	GMS-TS-P1	Top Pin Short .197 Brass 100PK





**KEY BLANKS**

**Vats Single-Sided (# 1-15)**



- |           |            |
|-----------|------------|
| HAB62-P-1 | HAB62-P-9  |
| HAB62-P-2 | HAB62-P-10 |
| HAB62-P-3 | HAB62-P-11 |
| HAB62-P-4 | HAB62-P-12 |
| HAB62-P-5 | HAB62-P-13 |
| HAB62-P-6 | HAB62-P-14 |
| HAB62-P-7 | HAB62-P-15 |
| HAB62-P-8 |            |

**Vats Double-Sided (# 2-15)**



- |           |            |
|-----------|------------|
| HAB82-P-2 | HAB82-P-9  |
| HAB82-P-3 | HAB82-P-10 |
| HAB82-P-4 | HAB82-P-11 |
| HAB82-P-5 | HAB82-P-12 |
| HAB82-P-6 | HAB82-P-13 |
| HAB82-P-7 | HAB82-P-14 |
| HAB82-P-8 | HAB82-P-15 |

- HAB111-SH-CP Circle+
- HAB108CY GMC CANYON KEY
- HAB108OE COLORADO ORIGINAL KEY

**Key Machine**

- HASD2LX FRAMON SIDEWINDER 2LX



HAB107CP GM Circle+



HAHAT-GMZ-CP  
GM Logo Circle + Z-Blade



HAHAT381CP Pontiac Circle+



HAHAT1718 Transponder Chry (Tan)



HAHAT-L-01 Lexus Shell 3-Button

**GENERICODE**

HAGCODEME

GENERICODE FOR WINDOWS

1006/4500 SERIES



**1006 Series Electric Strike**  
**Tamper Resistant - Fire Rated For Cylindrical & Mortise**

- Specifications:**
- Heavy duty, all stainless steel construction
  - High security, tamper resistant design
  - Dual interlocking – 3,000 lbs. Static strength
  - Enhanced spring design
  - Internally mounted solenoid
  - Horizontal adjustment
  - Continuous duty operation
  - Strike depth 1 7/8"
  - Plug-in connectors
  - 1000-105 "Goof Plate" adapter included



Shown with KM Option

- |           |                            |
|-----------|----------------------------|
| HEJ-2-630 | Satin Stainless Steel      |
| HEKD-613  | Bronze Toned               |
| HEJ-630   | Satin Stainless Steel      |
| HEKD-630  | Satin Stainless Steel      |
| HEKM-630  | Satin Stainless Steel      |
| HEK-630   | Faceplate 1006 Mort. Locks |
- K Option was replaced by the KM Option.*

**Strike Body Only**

- |             |                    |
|-------------|--------------------|
| HE1006-BLK  | w/blk keeper       |
| HE1006-630  | w/stainless keeper |
| HE1006F-630 | w/stainless keeper |

**Complete Strike**

- |                |                                     |
|----------------|-------------------------------------|
| HE1006CLB-630  | Complete Pac Latchbolts Fail-Secure |
| HE1006CS-630   | Complete Pac Fail-Secure            |
| HE1006CS-F-630 | Complete Pac Fail-Safe              |
| HE1006CAS-630  | Complete Pac Deadbolt Recapture     |

□ Includes faceplate/brackets for J, KD, & KM Options.  
\*\* Includes a SMART Pac III & five faceplate options.

**Faceplate Options:**

*(Faceplate: 4 3/8" x 1 1/2")*

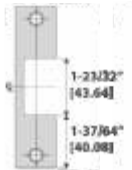

**J Option**

For use with: Cylindrical locksets with up to 3/4" throw and all locksets with center-lined bolts

Compatible locksets: All brands of cylindrical latchbolts

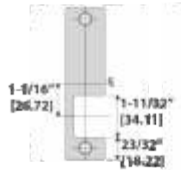

**KD Option**

For use with: Mortise locksets up to 3/4" throw latchbolt

Compatible locksets: Dorma 9500, Jackson, Sargent (7700 & 8100), Schlage, Yale (8700)

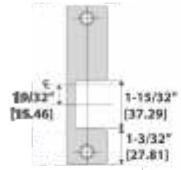

**KM Option**

For use with: Mortise locksets up to 3/4" throw latchbolt

Compatible locksets: Accurate, Arrow, Baldwin, Best, Corbin/Russwin, Falcon, Marks, PDQ, Sargent (7800, 8200 & 9200), Yale (8800)



**1600 SERIES**

- HE1600-106-630 1006 Adapter & Trim Enhancer
- HE1600-CDB-630 Complete PAC Deadbolt Locks
- HE1600-CLB-630 Complete PAC Latchbolt Locks
- HE1600-CS-630 Completer PAC Latch/Deadbolt

**1500 SERIES**

- HE1500C-630 Complete Electric Strike Kit

**1500/1600 SERIES PARTS**

- HE1DB-2-630 Wood Frame Deadbolt Faceplate
- HE1LB-2-630 Wood Frame Latchbolt Faceplate
- HEOPT-1DLM Dual Lock Monitor Kit For 1500 / 1600 Strikes
- HEOPT-1LM Single Lock Monitor Kit For 1500 / 1600 Strikes
- HE1500-106-630 Trim Enhancer



**4500 Series - 3hr Fire Strike**

- HE4500C-12/24-630 Satin Stainless Steel

*Designed for installation in 2" UL 10C fire-rated frames with 1/2" drywall penetration. Features a low profile 1-3/8" depth, heavy-duty cast stainless steel construction and horizontal adjustment for simple installation. Designed for use with cylindrical and mortise locksets up to a 3/4" throw. Includes faceplate options.*

5000/5200 SERIES

5000 Series Electric Strike - Low Profile-Heavy Duty For Cylindrical and Latchbolts

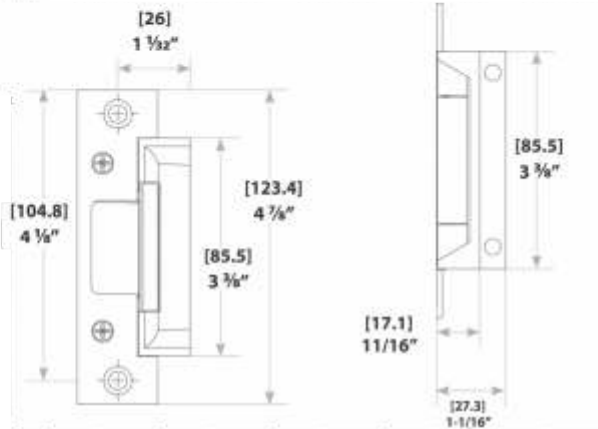

- Specifications:**
- Accommodates 1/8" - 3/8" latchbolt (3/8" with 1/8" door gap)
  - ANSI/BHMA A156.31
  - Static strength 1,500 lbs.
  - Dynamic strength 70 ft-lbs.
  - Endurance 500,000 cycles
  - Plug-in connector
  - Trim enhancer included
  - Five-year limited warranty

**5000 - Body Only**

HE5000-12/24D Reversible Full Sec/Safe

**5000 - Complete Pac**

HE5000C-630

Includes 501 & 501A faceplates

**Lip Extensions**

HE5104-1/2 1/2" Stackable Extension

HE5104-1 1" Stackable Extension

**Faceplate Options:**

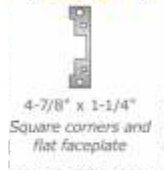

501-630  
501-613  
For use with: Cylindrical locksets in ANSI metal jambs.  
ANSI/BHMA Numbers: #E09321, #E09322, #E09323



501A-630  
501A-613  
For use with: Cylindrical locksets or spring latches used in aluminum frames. Includes universal mounting tabs.  
ANSI/BHMA Numbers: #E09321, #E09322, #E09323



502-630  
502-613  
For use with: Cylindrical locksets or spring latches used in aluminum frames. Includes universal mounting tabs.  
ANSI/BHMA Numbers: #E09321, #E09322, #E09323

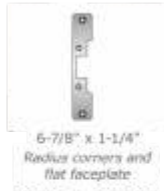

503-630  
503-613  
For use with: Cylindrical locksets or spring latches used in aluminum frames. Includes universal mounting tabs.  
ANSI/BHMA Numbers: #E09321, #E09322, #E09323



504-630  
For use with: Cylindrical locksets. Four-point mounting for wood installations.  
ANSI/BHMA Numbers: #E09321, #E09322, #E09323

**HE5200-12/24D  
5200 Electric Strike  
Horizontal Adjustability**



- Features**
- In-frame Horizontal Adjustment
  - Accommodates 3/8" - 3/4" latchbolt (3/8" with 1/8" door gap)
  - Strike body depth 1 3/16"



- HE5200-12/24D Body Strike  
HE5200C-630 Complete Pac  
HE5200-12/24D Strike Elec. 1 1/8 x 3/4"  
HE5200C-630 Complete PAK  
Includes 501 & 501A faceplates



**7000 SERIES**

**7000 Series Electric Strike Low Profile - Heavy Duty  
For Cylindrical and Rim Exit Devices**

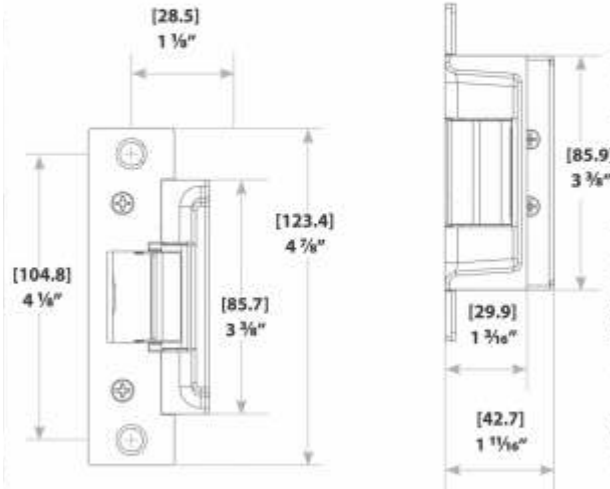

**SPECIFICATIONS**

*Specifications:*

- ANSI/BHMA 156.31
- MEA 166-002
- Continuous duty operation
- Horizontal adjustment
- Strike depth - 1-5/8"
- Plug-in connectors
- 12VDC current draw = .45 amps
- 24VDC current draw = .25 amps
- Warranty: Three year limited

**7000**

- HE7000 Dual Voltage Strike Body
  - HE7000-107 Shim Pac
  - HE7000C-630 Complete Pac Dual Voltage
- ☐ Includes 791 & 792 Faceplates

**Faceplate Options:**



**791**

For use with: Cylindrical locksets up to 5/8" throw.  
HE791-630



**792**

For use with: Cylindrical locksets up to 5/8" throw.  
HE792-630



**7895-626C**

For use with: Rim exit devices in aluminum jambs with up to a 3/4" pullman latch. Includes keeper pocket adapter.

Compatible locksets: American Device, Arrow, Dor-O-Matic, Jackson, Monarch, Precision, Sargent, Von Duprin, Yale

HE7895-626C



## 8000/8300 SERIES

### 8000 Series



**Features:**

- No cutting on frame required
- Vertical adjustability
- Accommodates 1/2" - 5/8" latchbolt
- Plug-in connector
- Grade 1
- 12/24-AC/DC
- 8300 is FIRERATED

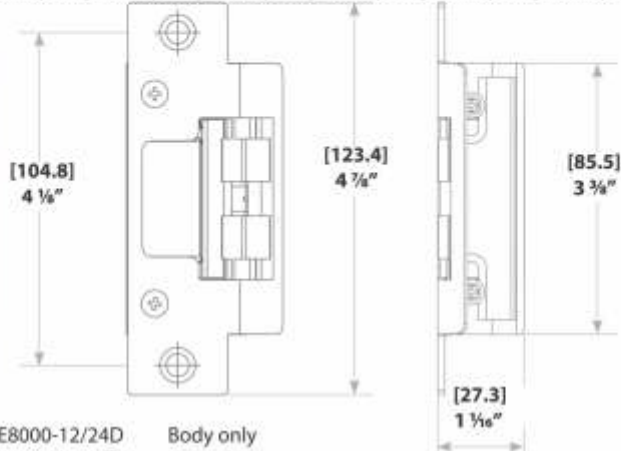

HE8000-12/24D	Body only	<b>Faceplates</b>	
HE8000C-630	Complete Pac	HE801-613	Bronze
HE8300	Body Rated 3hr Fire	HE801-630	Stainless Steel
HE8300C-630	Complete Pac		
□ Includes 801 & 801A Faceplates			

## 8500 SERIES



**Features:**

- No cutting of the face of the frame
- Accommodates 3/8" mortise latchbolts
- Plug-in connector
- Full pocket shims for horizontal adjustment
- Five year limited warranty
- Fail secure
- UL 10C-<sup>re</sup>-rated, 3 hour

CMH-5704 <sup>re</sup> door conformant; NFPA80-07  
 Conformant; ANS/WHMA A156.81; NFPA-252 <sup>re</sup> door  
 conformant; ASTM-E152 <sup>re</sup> door conformant; UBC-  
 7-2-94, Uniform Building Code

Two different faceplate pocket styles  
 with three different deadlatch plat-  
 form profiles for compatibility with a  
 wide variety of mortise locksets.

Two faceplates included in each kit:  
 a standard faceplate and a faceplate  
 with a wider pocket to address less-  
 than-ideal sagging door conditions



HE8500 Body only

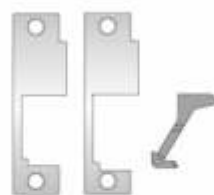
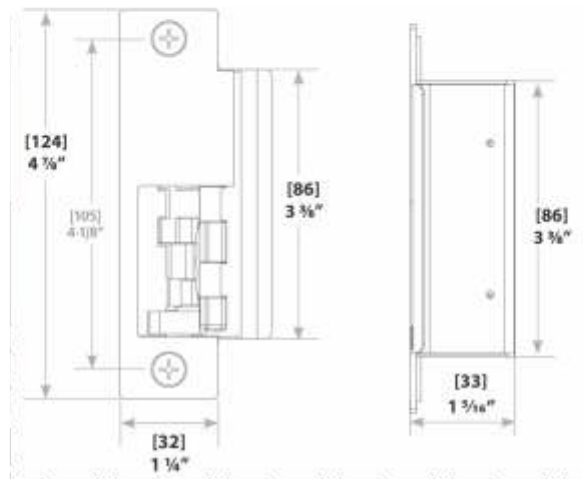

4-7/8" x 1-1/4"

**Faceplate Options:**

**HE851M-630**  
 Compatible locksets: Sargent 8100, 8200, 9200

**HE852K-630**  
 Compatible locksets: Corbin Russwin ML 2000

**HE852L-630**  
 Compatible locksets: Schlage L9000

**HE852M-630**  
 Compatible locksets: Yale 8700 (manufactured after 2005)  
 & 8800, Accurate, Falcon, Kaba Ilco/Unican

9400-9600 SERIES

HES 9400 Electric Strike

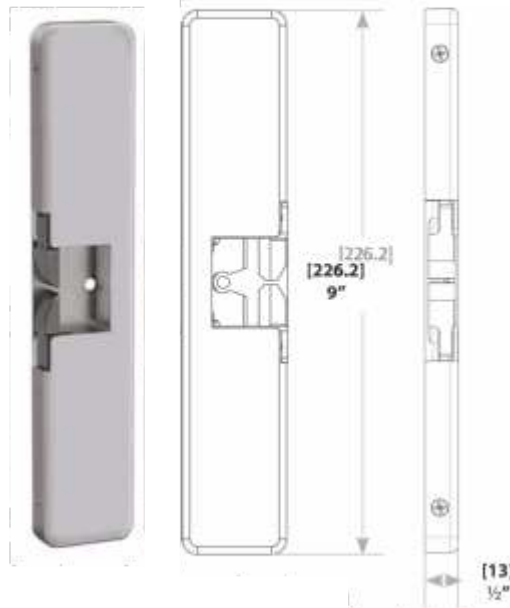

Features:

- Completely surface mounted
- Stainless steel construction
- Static strength 1,500 lbs.
- Dynamic strength 70 ft-lbs.
- Endurance 500,000 cycles
- Internally mounted solenoid
- Accommodates up to 1/2" pullman latch
- ANSI/BHMA, A156.31
- (#E09731, #E09732, #E09373)
- Patent 6,390,520 & patent pending

9400 - 1/2" Depths

- HE9400-613E 12/24V, DC
- HE9400-630 12/24V, DC
- HE9400-613 12/24V, DC

9500 / 9600 Genesis Electric Strike

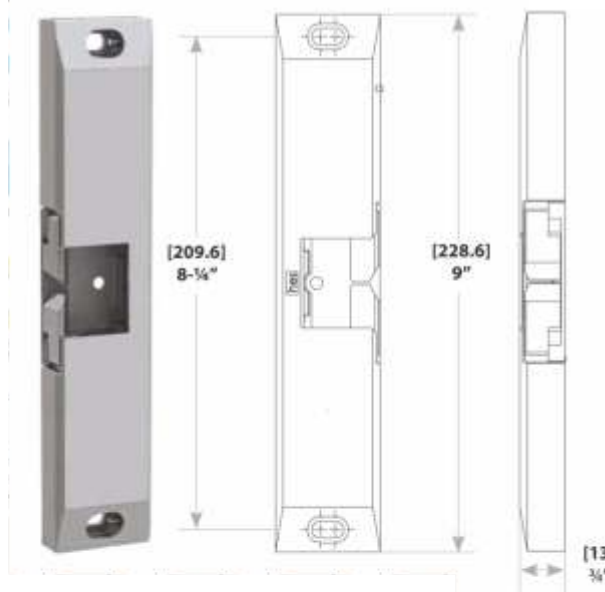

Features:

- Durability minimum 500,000 cycles
- Horizontal adjustment
- Continuous duty operation
- Stainless steel construction
- Low current draw
- Plug-in connectors
- Internally mounted solenoid
- ANSI/BHMA, 156.31

9500 - 3/4" Depths Fire Rated

- HE9500-630 Fire Rated

9600 - 3/4" Depths

- HE9600-613E 12/24V, DC
- HE9600-630 12/24V, DC
- HE9X00-108-BLK Spacer Plate



HE9700-630 For Corbin Russwin Securebolt



**HE9800-613E**  
Strike Elec Surf MT Starwheel  
**HE9800-630**  
Strike Elec Surf MT Starwheel



**HE9000-MTK - Metal Installation Template**

Works with:  
9400  
9500  
9600



**CABINET LOCKSET**

**660 Multi-Purpose Locks**

The 660 electro-mechanical lock is a surface-mounted, electric multi-purpose lock, perfect for drawers and cabinets.

HE660-12D-STD	Drawer/Cabinet
HE660-24D-STD	Drawer/Cabinet
HEK20	Standalone 13.56 MHz Cabinet Lock
HEKP20	Standalone Keypad Cabinet Lock

**Features:**

- All metal construction
- Adjustable mounting brackets with 1/4" lockdown feature
- 6 foot cable lead



HEK20

**ACCESSORIES**



**HE150**  
Strike Latch Guard

- Features:**
- Stainless steel
  - Installed at the edge of the door to cover the lock & strike



**HE2005M3**  
Smart-Pac III™



**HE2001M Plug-in Bridge Rectifier**  
Converts AC to DC. 35 V, 1 Amp.

HE2001M Plug-in Rectifier  
HE2001-1 Wire-In Rectifier



**HE2006M**  
Plug-in Buzzer



**HE 2007M**  
Plug-in Pigtail Connectors  
With 4" wire leads.



**HE2004M**  
ElectroLynx Adapter



**HEHESCUT-MTK Metal Template Kit 4 7/8" Jamb**

## TOOLS

### The Hinge Doctor

The Hinge Doctor set of tools is a great way to repair those sagging metal doors! All you do to fix it is to slip the tool over the hinge and open the door. This action causes the door hinge to bind while the tool is in place. Open the door only an inch or two past the point where it binds against the tool, then remove the tool from the hinge and check the door.

- HDB15 Snap In Bridge
- HDHA1D For Standard Commercial 4 1/2" x 4 1/2" Butt Hinges
- HDHA2 For Residential Hinges
- HDHA3D For Ball-Bearing and Larger Commercial Hinges
- HDHA4D For Prison & Institutional Hinges & Standard Spring Hinges
- HDADD1A Repair Disk (Pair) Clear
- HDADD1D Repair Disk (Pair) Duro
- HDHA123D Set of 1, 2, 3
- HDHA1-4D SET Complete Set
- HDHSP10M Oversized Hinge Screws, Metal Frames- 10 Pack
- HDHSP50M Oversized Hinge Screws, Metal Frames- 50 Pack
- HDHSP100M Oversized Hinge Screws, Metal Frames- 100 Pack
- HDHSP50W Oversized Hinge Screws, Wood Frames- 50 Pack
- HDSK1 Spanner Kit for Kits B1A & B1D

Model	Color
HA1D	Black
HA2	Green
HA3D	Blue
HA4D	Red



Get the Hinge Doctor® in a convenient KIT or in 3 individual sizes. Each one is used for several different sizes and types of hinges.



### Aluminum Door Repair Kit - HD B1D



Storefront Door Modification Kit, Duro 313: with 3 Snap-In Bridges, 1 Set ADD2D Cylinder Hole Discs, 1 ADD1D Disc to cover Indicator Hole & 2 New Custom Duro 313 Blank Faceplates (1 Radius & 1 Beveled)

### Aluminum Door Repair Kit - HD B1A



Storefront Door Modification Kit, Aluminum 628: with 3 Snap-In Bridges, 1 Set ADD2A Cylinder Hole Discs, 1 ADD1A Disc to cover Indicator Hole & 2 New Custom Aluminum 628 Blank Faceplates (1 Radius & 1 Beveled)

## HOUDINI



HO11012 Lock Lube 11oz



HO23201 Super Slick 4-way 2oz

## CUTTERS

### 1200 Series



**HPCW-14MC**  
**Cutter-Large Cyl**  
 100° angle - 0.046" Flat (1.168mm)  
 Standard large cylinder cutter



**HPCW-1012**  
**Cutter-Medeco High Security Milling**  
 86° angle - 0.015" Flat (0.38mm)  
 Optional milling cutter has angle & pin seat  
 for cutting Medeco® High Security



**HPCW-20FM**  
**Cutter-Sargent**  
 76° angle - 0.0635" Flat (1.612mm)  
 Double angle, lat mill tooth for Sargent

### SPEEDEX SINGLE ANGLE CUTTERS



**HPCW-23MC**  
**Cutter-Sargent**  
 45° angle - 0.03" Flat (0.762mm)  
 Single Angle Cutters



**HPCW-32MC**  
**Cutter-ASSA/HPC 1200CM**  
 90° angle - 0.032" Flat (0.812mm)  
 Specially designed tool steel cutter  
 for ASSA keys.

### SPEEDEX DOUBLE ANGLE CUTTERS



**HPCW-45SMS**  
**Cutter-Slotter - Side Milling**  
 0.045" Flat (1.14mm)  
 M2 tool steel combination standard/lat  
 steel cutter for safe deposit boxes  
 (requires spacer SPR-5 with 1200 Series Machines)



**HPCW-47MC**  
**Cutter-Double Angle 1/2"**  
 87° angle - 0.035" Flat (0.889mm)  
 Tool steel cutter for some automotive.



**HPCW-41HQC**  
**Cutter-Carbide Milling**  
 60° angle - 0.010" Radius (0.254mm)  
 Carbide cutter for  
 3344 and 6666 Series machines



**HPCW-90MC**  
**Cutter-Large Cyl**  
 90° angle - 0.046" Flat (1.168mm)  
 Large cylinder cutter for shallow & deep cuts  
 in adjacent positions. For Best, Falcon, Eagle,  
 Arrow, Kaba, and IC core.



**HPCW-42HQT**  
**Cutter-Milling**  
 60° angle - 0.010" Radius (0.254mm)  
 Tool steel cutter for  
 3344 and 6666 Series machines



**HPCW-1011**  
**Cutter-small Cyl**  
 90° angle - 0.044" Flat (1.117mm)  
 Small cylinder cutter

### CODE CARDS

#### 1200CMB Blitz™/Switch Blitz™ Series Code Cards

HPCF235	Hyundai 10-cut	HPCX263	Saturn Ion
HPCX101	New Ford, 8-cut	HPCSP3	Medeco Bi axial
HPC108H	Code Card USCAN		

## LOCK CADDY

HPLC-CONV Lock Caddy for Conventional  
 HPLC-GATOR-KIT Lock Caddy Following and Aligning  
 HPLC-HSR-KIT Lock Caddy High Security Ring Kit  
 HPLC-LFIC Lock Caddy for Large Format IC  
 HPLC-SFIC Lock Caddy for Small Format IC



HPLC-CONV



HPLC-HSR-KIT



## KEY MACHINES



### HPCMB-CK Blitz™ Series Calibration Kit

This easy to use tool kit is for use with all 1200CM Blitz™. It is designed to quickly and accurately diagnose whether your machine is out of calibration. If it is out of calibration, the kit can then be used to calibrate your machine with just a few simple steps.



### HP 9160MC Premier Speedex®

The Premier Speedex® (9160MC) is a manual duplicator, perfect for duplicating even the largest keys, such as hotel/motel room keys. It is equipped with 4-way jaws for holding a large variety of different blanks, including double sided keys (such as foreign automotive keys). The Premier Speedex™ is mounted on a sturdy base and comes equipped with a heavy-duty motor. It also comes equipped with the HPC Softie™ de-burring brush.

## KEY MACHINE PARTS

### Thrust Bearing Washer Set HPBBW-2



This set includes 2 ball bearing units and 4 hardened steel washers for key machine wing nut studs.



### Tip Stop-Ford HPCM-1054R

For use with 7-pin Best and 10-cut Ford on 1200CMB Blitz™, Switch Blitz™, Code Max™, and Trace-A-Key™ Series machines.



### Brass Plated Key Shim HPKBPS-1

This brass plated steel key shim (on chain) helps prevent hard to hold keys from tilting. For use with CodeMax™, Blitz™ and 1200CM machines.



### Replacement Wing Nut HPSNK-3

This sturdy blue wing nut is virtually indestructible! Fits all HPC 1200 Series, Speedex™ Series, Trace-A-Key™, Automate™, and Drill Mill.



### Softie Brush HPTYX-3

The HPC Softie™ brush is the only key machine brush made of Tylon-X. The carbide impregnated brush de-burrs faster, smoother, and lasts 6 times longer than wire.



### Medeco Freedom Jaw HPMJ-3

With this jaw you are able to cut Medeco® 3 Freedom keys on your Blitz™, Switch Blitz™, and CodeMax™ machines.

### Vise-Index Key (Tip Stop)



HPCM-1019MA Vise-Stud Key  
HPCM-1054MA Vise-Index Key

Standard replacement tip stop for the 1200 CMB Blitz™, Switch Blitz™, Code Max™, and Trace-A-Key™ Series machines.

## LATCH PROTECTORS

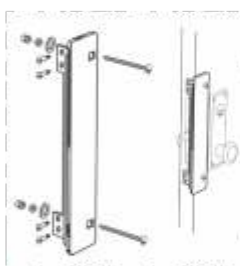

### Heavy Duty Guard Plate

(For Doors Opening Out)  
1 3/4" W x 14" H - Duro-Bronze

The VDG-10 is our strongest and most popular guard plate. It is 14" long and is made from 2 pieces of 16 gauge cold rolled steel, welded together with a baked brown enamel finish. This guard plate offers maximum resistance to prying and forcing.  
HPVDG-10

### Offset Guard Plates



Offset Guard Plates are used on vestibule doors with projecting door casings (for doors that are not flush with the frame). These plates are easily installed by drilling only 2 holes and using the pair of through bolts and nuts. The guards are made of 16 gauge cold rolled steel and have a silver finish. The 14" overall length extends 3" beyond the average lock face, protecting against unauthorized, forcible entry. There are 4 sizes available. All guard plates come complete with all necessary hardware and illustrated instructions.



### Guard Plate

(For Doors Opening Out)  
1 1/2" W x 5 3/8" H - Bright Zinc

HPODG-6

All doors using spring latch type locks should have the added protection of a latch/bolt guard. The changes of these guards will keep any prying tools away from the latch.

(For Doors Opening Out)  
14" H x 1 3/8" W - Silver Finish



HPOVDG-11 HPOVDG-12 HPOVDG-13 HPOVDG-14

## SECURITY STORAGE



### KEY CABINETS

#### Single-Tag KeKabs®

HPC's single-tag key security control system is designed to control and provide security for 8 to 730 keys. KeKabs® are ideal for home, store, or office use, where centralized or departmental key control is desired. They are designed to be mounted on a wall, near a desk or a work station.

Each HPC KeKab® Security Control System Includes:

- White Plastic Key Tags with bright nickel plated snap-hooks which can hold multiple keys on each snap-hook. The tags are numbered for easy identification.
- "Out Key" Control Tags that are made of yellow paper. They are used for accountability (to record information on loaned keys).
- Lock Location Data which consists of an erasable lock location chart as part of the KEKAB-8 and numbered key control booklets with all other KeKabs®.
- Durable Steel Key Racks that are slotted to store key tags uniformly for immediate identification.
- It comes with a key retaining 5-wafer cam lock.
- Unique powder coat textured painting process which provides an attractive and very durable finish. The neutral sand color allows them to be hung anywhere.
- Heavy Gauge Steel Construction with piano hinged doors and key panels provides a sturdy location to secure your keys.

#### USE KEY BLANK FL K54G

The "X" at the end of a stock number denotes that the cabinet is expandable.





Part No.	Capacity	Dimensions			Weight	Lock		
HPKEKAB-8	8 Keys	6 5/8"	x	5 3/4"	x	2"	2 lbs	5-wafer cam lock.
HPKEKAB-30	30 Keys	12"	x	8"	x	2 1/2"	4 lbs	5-wafer cam lock.
HPKEKAB-40	40 Keys	12"	x	8"	x	2 1/2"	4 lbs	5-wafer cam lock.
HPKEKAB-60	60 Keys	17"	x	13"	x	3 1/4"	10 lbs	5-wafer cam lock.
HPKEKAB-KK65	65 Keys	17"	x	13"	x	3 1/4"	10 lbs	accepts mortise cylinder
HPKEKAB-80	80 Keys	17"	x	13"	x	3 1/4"	10 lbs	5-wafer cam lock.
HPKEKAB-KK95X	95 Keys (Expands to 265 Keys)	20"	x	16 1/2"	x	5"	19 lbs	accepts mortise cylinder
HPKEKAB-120	120 Keys	17"	x	13"	x	3 1/4"	10 lbs	5-wafer cam lock.
HPKEKAB-160X	160 Keys	20"	x	16 1/2"	x	5"	---	---
HPKEKAB-240	240 Keys	20"	x	16 1/2"	x	5"	22 lbs	5-wafer cam lock.
HPKEKAB-260X	260 Keys (Expands to 500 Keys)	25 1/2"	x	18"	x	5 1/2"	29 lbs	5-wafer cam lock.
HPKEKAB-330	330 Keys	20"	x	16 1/2"	x	5"	23 lbs	5-wafer cam lock.
HPKEKAB-A	Expands 160 Keys to 330 Keys	18"				14 3/4"	6 lbs	---
HPKEKAB-B	Expands 260 Keys to 500 Keys	23"				6 3/4"	10 lbs	---

HPKEKAB-30-BKRW-DL Black W/Red Wood, Digital



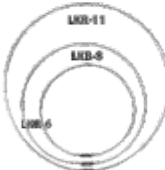
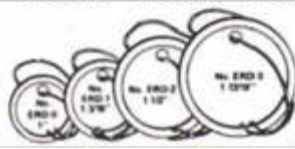

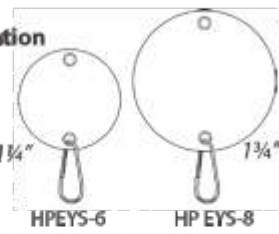
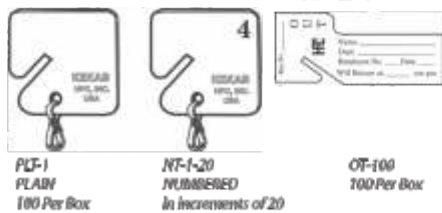
## SECURITY STORAGE — *continued*

<p><b>Over-Door Key Keeper™</b> HPKEP-12-96</p> 	<p>The Over Door Key Keeper™ is perfect for preventing lost keys and lockouts! Secure one key or several in the keeper. The box is placed over the top edge of the door. When the door is closed, the top mounting screws are hidden. The key keeper has a sturdy piano hinged door. It is made of heavy gauge steel and has a glossy white finish.</p>														
<p><b>KEY RINGS</b> <b>Large Key Rings</b></p> 	<p>HPC's Large Key Rings are made of half-hard steel. The threaded fastener screws either to the left or the right allowing access on both sides or the ring. The 11" ring slips over head easily for carrying around the neck and will hold about 260 keys.</p> <table style="width: 100%; border: none;"> <tr> <td>HPLKR-6</td> <td>6" Diameter</td> </tr> <tr> <td>HPLKR-8</td> <td>8" Diameter</td> </tr> <tr> <td>HPLKR-11</td> <td>11" Diameter</td> </tr> </table>	HPLKR-6	6" Diameter	HPLKR-8	8" Diameter	HPLKR-11	11" Diameter								
HPLKR-6	6" Diameter														
HPLKR-8	8" Diameter														
HPLKR-11	11" Diameter														
<p><b>KEY TAGS &amp; RINGS</b> <b>Utility Tags</b></p> 	<p>For use on heavy or much handled merchandise, where strength and non-mutilating qualities are required. These metal rim utility tags are manufactured from heavy stock with a smooth writing surface. Each tag has an attached string, looped and knotted. Packed 100 per Box.</p> <table style="width: 100%; border: none;"> <tr> <td>HPERD-0</td> <td>1" / 2.54cm Diameter</td> </tr> <tr> <td>HPERD-1</td> <td>1-3/16" / 3.02cm Diameter</td> </tr> <tr> <td>HPERD-2</td> <td>1-1/2" / 3.81cm Diameter</td> </tr> </table>	HPERD-0	1" / 2.54cm Diameter	HPERD-1	1-3/16" / 3.02cm Diameter	HPERD-2	1-1/2" / 3.81cm Diameter								
HPERD-0	1" / 2.54cm Diameter														
HPERD-1	1-3/16" / 3.02cm Diameter														
HPERD-2	1-1/2" / 3.81cm Diameter														
<p><b>Emergency Key Box</b> HP 511</p>  <p style="font-size: small; margin-top: 5px;">6 3/8" H, 5 3/8" W, 2" D 2 lb, 6 oz</p>	<p>This box is designed to secure a restricted key where it is needed. The bright red steel box has a key-locking hinged door with a plexiglass window. When an emergency arises and access to the key is necessary, break the plexiglass with the attached hammer. <b>The Fire Department Box comes with dark plexiglass to hide the contents.</b> The Emergency Key Boxes (shown above) come with a 5-wafer cam lock. Emergency Key Boxes are stocked keyed-randomly.</p> <table style="width: 100%; border: none; margin-top: 5px;"> <tr> <td>HP511</td> <td>Emergency Key Box</td> </tr> <tr> <td>HP511-GLASS</td> <td>Replacement Glass</td> </tr> </table>	HP511	Emergency Key Box	HP511-GLASS	Replacement Glass										
HP511	Emergency Key Box														
HP511-GLASS	Replacement Glass														
<p><b>KEY TAGS &amp; RINGS</b> <b>Tags for Key Identification</b> <i>Packed 100 per Box</i></p> 	<p><b>KEY CABINET ACCESSORIES</b> <b>KeKab® Accessory Tags</b></p> <p>KeKab® Accessory Tags fit all KeKab®, Key Boards, Key Racks and Carrying KeKab®. The key tags are available numbered or plain.</p> <table style="width: 100%; border: none; margin-top: 5px;"> <tr> <td>HPNT-1-20</td> <td>Numbered</td> </tr> <tr> <td>HPNT-21-40</td> <td>Numbered</td> </tr> <tr> <td>HPNT-41-60</td> <td>Numbered</td> </tr> <tr> <td>HPNT-61-80</td> <td>Numbered</td> </tr> <tr> <td>HPNT-81-100</td> <td>Numbered</td> </tr> <tr> <td>HPOT-100</td> <td>Tag-Out</td> </tr> <tr> <td>HPPLT-1</td> <td>Tag-Plain</td> </tr> </table>  <p style="font-size: x-small; margin-top: 5px;"> <b>PL-1</b> PLAIN 100 Per Box  <b>NT-1-20</b> NUMBERED In increments of 20  <b>OT-100</b> 100 Per Box     </p>	HPNT-1-20	Numbered	HPNT-21-40	Numbered	HPNT-41-60	Numbered	HPNT-61-80	Numbered	HPNT-81-100	Numbered	HPOT-100	Tag-Out	HPPLT-1	Tag-Plain
HPNT-1-20	Numbered														
HPNT-21-40	Numbered														
HPNT-41-60	Numbered														
HPNT-61-80	Numbered														
HPNT-81-100	Numbered														
HPOT-100	Tag-Out														
HPPLT-1	Tag-Plain														
<p><b>HPINV-1</b> <b>Key Blank Inventory Control Tags</b></p> 	<p>These tags offer a quick visual method of controlling key blank inventory. Simply mount these bright yellow tags directly on the hook in front of your determined "order point." They are printed in black and red on heavy card stock with a metal grommet.</p>														

## PICK SETS







<p><b>Deluxe Pick Set</b> HP NDPK</p> 	<p><b>Features:</b></p> <ul style="list-style-type: none"> <li>• It contains a mix of rake, diamond, hook, ball, and double ball tip picks; light, medium, and heavy weight tension wrenches; and saw type key extractors.</li> <li>• Shirt Pocket Size: 2 3/8" x 6 3/8"</li> <li>• Genuine Leather Case with Zipper</li> <li>• Contains 10 Picks, 4 Tension Tools and 2 Extractors</li> <li>• Hardened Spring Steel Components</li> </ul> <table style="width: 100%; border: none; margin-top: 5px;"> <tr> <td>HPNDPK</td> <td>Deluxe Pick Set</td> </tr> <tr> <td>HPNDPK-CASE</td> <td>Leather Case</td> </tr> </table>	HPNDPK	Deluxe Pick Set	HPNDPK-CASE	Leather Case
HPNDPK	Deluxe Pick Set				
HPNDPK-CASE	Leather Case				
<p><b>Superior Pick Set</b> HPNDPK-32</p> 	<p><b>Features:</b></p> <ul style="list-style-type: none"> <li>• Shirt Pocket Size (Closed): 2 3/8" x 6 3/8"</li> <li>• Genuine Leather Case with Full Zipper</li> <li>• Contains 22 Picks, 7 Tension Tools and 3 Extractors</li> <li>• Hardened Spring Steel Components</li> </ul>				



**PICK SETS — continued**

<p><b>Pro-Mixer Pick Set</b> HPNDPK-24</p>  <p><b>Features:</b></p> <ul style="list-style-type: none"> <li>• Consists of 14 picks, 5 tension tools, and 5 extractors</li> <li>• Stainless Steel &amp; Spring Steel</li> </ul>	<p><b>Electropick</b> HPEPG-1</p>  <p><b>Features:</b></p> <ul style="list-style-type: none"> <li>• Ergonomic grip</li> <li>• Open pin and disc tumbler cylinders</li> <li>• Adjustable</li> <li>• Complete with a 120VAC or 240VAC charger, 4 pick blades and 2 tension tools</li> </ul>	<p><b>Double-Sided Pick Set</b> HPDSP-1</p>  <p><b>Features:</b></p> <ul style="list-style-type: none"> <li>• Shirt Pocket Size: 3-1/2" x 5-3/8"</li> <li>• Blue Plastic Case</li> <li>• Contains 4 Double-Sided Picks</li> <li>• Hardened Spring Steel Components</li> </ul>
<p><b>Novice Pick Set</b> HPPIP-13</p>  <p><b>Features:</b></p> <ul style="list-style-type: none"> <li>• Contains 7 picks, 3 tension tools, and 1 broken key extractor</li> <li>• Hardened spring steel</li> <li>• Leather case with snap</li> <li>• Shirt Pocket Size: 1 3/4" x 5 5/8"</li> </ul>	<p><b>Tyro Pick Set</b> HPPIP-15</p>  <p><b>Features:</b></p> <ul style="list-style-type: none"> <li>• Contains 6 picks, 2 tension tools and 1 broken key extractor</li> <li>• Hardened spring steel</li> <li>• Leather case with snap</li> <li>• Shirt Pocket Size (Closed): 1 3/4" x 5 5/8"</li> </ul>	<p><b>Jackknife Pick Set</b> HPJKP-5</p>  <p><b>Features:</b></p> <ul style="list-style-type: none"> <li>• Contains 2 rakes, 1 diamond, 1 hook and 1 tension tool</li> <li>• Shirt Pocket Size: 1 3/4" x 5 5/8"</li> <li>• Hardened Spring Steel</li> </ul>
<p><b>Warded Padlock Pick Set</b> HPPKS</p>  <p><b>Features:</b></p> <ul style="list-style-type: none"> <li>• Fits in your Pocket</li> <li>• Contains 5 Picks with • Key Ring</li> <li>• Hardened Spring Steel</li> </ul>	 <p><b>HPCOLOR-L35</b> Lady Locksmith Pick Set</p>	
<p><b>2000 Series Extractor Set</b> HPES-2000</p>  <p>The 2000 Series Extractor Set tools are designed to slide next to broken keys along the side mill and ride along the bottom pins to hook into a cut in the key. The tools are made of high grade stainless steel and can be bent to reach around many obstacles. This 4-piece set makes all other extractors obsolete.</p>	 <p><b>HPCOLOR-R16</b> Renegade Pick Set</p>  <p><b>HPCOLOR-S35</b> Stealth Pick Set</p>	

**PICKS & PICK ACCESSORIES**

<p><b>Pick Grip Handle</b> HPPICK-GRIP</p>  <p><b>Features:</b></p> <ul style="list-style-type: none"> <li>• 3/8" round, and the inside diameter expands to also hold: files, wire cutters, pin tweezers, car openers, etc</li> <li>• Provides maximum pulling grip for key extractors</li> </ul>	<p><b>Replacement Pick Blades</b> HPP-2</p>  <p><b>Features:</b></p> <ul style="list-style-type: none"> <li>• Fits Electropick™, Pistolpick™, and the Stainless Steel Pen Pick Set</li> <li>• Hardened spring steel (.035" thick)</li> </ul>	<p><b>Model B Tubular Pick</b> HPTLP-CMOD-B</p>  <p><b>Features:</b></p> <ul style="list-style-type: none"> <li>• Aluminum handle, stainless steel barrel, spring steel feelers</li> <li>• Leather case with the TKPD-1 decoder</li> </ul>	<p><b>Padlock Shim Picks</b> HPPSA-20</p>  <p><b>Features:</b></p> <ul style="list-style-type: none"> <li>• 20 piece set</li> <li>• Contains 5 of each of the most common shackles diameters</li> <li>• Stainless Steel</li> </ul>
<p><b>Flip-It™</b> 4 1/2 x 1 1/2" (11.5 x 3.5cm) HPFIT-2</p>  <p><b>Features:</b></p> <ul style="list-style-type: none"> <li>• Flips the cylinder plug past the upper pins</li> <li>• 2-Pin Quick Lock/Release feature</li> <li>• Sure stop feature</li> </ul>	<p><b>Key Extractors</b></p>  <p>HPEZ-1 (.022) - Saw Type HPEZ-2 (.022) - Hook Type HPEZ-5 (.040) - Spiral Type</p>	<p><b>PICK TIPS</b> Spring Steel / Stainless Steel Handled Picks</p>  <p>HPLPX-10 Diamond .022 HPLPX-11 Rake .022 HPLPX-12 Hook .022 HPLPX-15 Rake .022</p>	

**PICKS & PICK ACCESSORIES — continued**
**Interchangeable Extractor Set**

- Features:**
- Includes 4 extractor blades: 1 saw type extractor blade; 2 round extractors (.040") and 1 round extractor (.050").
  - Shirt Pocket Size (Closed): 1/4" x 3 1/2" (0.65 x 9cm)
  - Stainless Steel
- |         |                           |
|---------|---------------------------|
| HPEZ-6  | Extractor Key/Set (4/BLD) |
| HPEZ-7A | 10 Saw-Type               |
| HPEZ-7B | 10 Spiral-Type            |
| HPEZ-7C | 10 Round-Type             |

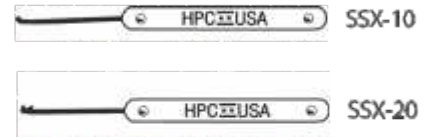
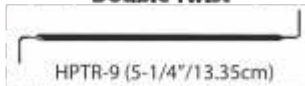
**2000 Series Extractor  
Stainless Steel (.020)**

**TOOLS**
**Standard Tension Tools**
**LIGHT TENSION**
**Double Twist**

HPTR-9 (5-1/4"/13.35cm)

**MEDIUM TENSION**
**Double Twist**

 HPTR-25  
(5-1/4"/13.35cm)

**Single Side Twist**

 HPTR-14 1/2" (1.45cm)  
(4")

**Double Twist**

 HPTR-24  
(4"/10.15cm)

**Single Side Twist**

 HPTR-13  
(3-1/4"/8.25cm)

**RIGID TENSION**

**Twist & Straight**  
HPTR-4  
(2-1/4"/5.70cm)

**Straight**  
HPTR-3  
(2-1/4"/5.70cm)

**Double Sided Grooved**

HPV V-6 (2"/5.08cm)

**Cylinder Eater  
HPCE-6000**

This revolutionary drill attachment eats through cam locks, file cabinet locks, knob locks, deadbolts, padlocks and more!

**Double-Sided Tension Tools**

These tension tools are for use on double-sided locks such as automotive door locks, furniture, cabinets, and other cam locks.

**HPTEN-7 Zinc Plated, Medium Tension**

**HPTEN-9 Black, Rigid Tension**
**Variable-Size Tension Wrench  
HPSTW-3**

The tip of this tension wrench can be compressed to fit into keyways of various sizes. The STW-3 is designed for standard locks, including automotive door locks.

**Plug Followers**

These Plug Followers will fit virtually all of the rim or mortise cylinders currently in use. They are made of centerless ground bar stock.

**HPSUT-1 (.495" / 12.6mm Diameter)**

**HPSUT-10 (.550" / 14mm Diameter)**

**Hollow Brass Follower Set  
HPSUT-14**

- Small = .395
- Medium = .495
- Large = .550

**Features:**













- Contains 3 popular sizes of chrome plated, hollow brass followers.
- Use on a variety of locks including the Corbin Russwin heavy duty knob lock cylinder units.

**PLUG FOLLOWER CHART**

Manufacturers	Follower
Acrollock	SUT-1
Almont (Peanut Cylinder)	SUT-8
Amore	SUT-1
Corbin	SUT-1
Corbin Oversize	SUT-10
Corbin (Small Pins)	SUT-8
Dexter	SUT-1
Eagle	SUT-1
Eagle (Small Pin)	SUT-8
Iico	SUT-1
Iico (4019 Rim Cylinder)	SUT-3
Iico (Peanut Cylinder)	SUT-8
Keil	SUT-1
Keil (No. 38 Rim Cylinder)	SUT-3
Kwikset	SUT-1
Lockwood	SUT-1
Lockwood (986 Rim Cylinder)	SUT-3
National of Rockford (Except NRG)	SUT-1
Russwin (.500" Diameter)	SUT-1
Russwin (Oversize)	SUT-10
Sargent	SUT-1
Schlage	SUT-1
Segal	SUT-1
Taco	SUT-1
Taylor	SUT-1
Weiser (All but Beverly)	SUT-1
Welch	SUT-1
Weslock (Except BNR)	SUT-1
Yale	SUT-1
Yale (Small Pin)	SUT-8



**TOOLS** — *continued*

<p><b>Pin Tumbler Tweezers</b> HPPTT-4</p>  <p><i>Features:</i> • Milled back so that the outside diameter of a standard .115" pin extends past the tip</p>	<p><b>Compact Pin Tumbler Tweezers</b> HPPTT-5</p>  <p><i>Features:</i> • 4" long • Milled tips</p>	<p><b>Pin Tumbler Tweezers with Pin Pushing Attachment</b> HPTPT-5</p>  <p><i>Features:</i> • Attachment easily removable 6" (15.25cm) Long</p>
<p><b>Truarc Ring Pliers</b> HPTRU-55</p>  <p><i>Features:</i> • Combination Ring Spreading and Compressing • Two pivot center allows for dual operation</p>	<p><b>Ring Spreader</b> HPTRU-122</p> 	
<p><b>Lever Handle Remover</b> HPLHR-100</p>  <p><i>Features:</i> • Designed to quickly remove locked lever handles for servicing</p>	<p><b>Mortise Cylinder Lock Tap &amp; Die Set</b> HPCLTD-5</p>  <p><i>Features:</i> • Holding Fixture secures a stripped mortise cylinder in your vise while you use the Die to repair stripped threads</p>	
<p><b>Tubular Lock Saws</b></p>  <p><b>G-1</b> Hollow Drills Fit into Holder</p>  <p><b>AG-1</b></p>  <p><b>Holder</b></p> <p><i>If picking is not possible, lock-outs of tubular key locks can still be serviced. These hole saws destroy the pins at the shear line. Hole saws are available for standard and oversize keyways. Saws will fit any 1/4" electric drill. Saw life is approximately 3 openings. Not for use on locks with hardened pins or ball bearings in the keyway.</i></p> <p><b>HPAG-1</b> Standard Size Tool/Extra Saw <b>HPG-1</b> Replacement Saw for AG-1</p>	<p><b>IC Tail Turner</b> HPICT-2</p>  <p><i>This dual-end tool is designed to fit standard (.500") and large format (.550") interchangeable core housings. It grabs onto the two fingers of the tail piece and allows you to position them for easier core insertion.</i></p>	
<p><b>Cylinder Drill Jig</b></p> <p><i>Features:</i> • Perfect alignment on the shear line for drilling with the included bit</p>	<p><b>Cylinder Drill Jig and Drill Bit for Flat Face Cylinder</b> HPCDJ-1</p> 	



**TOOLS — continued**
**Graphite Gun**  
**HPHGG**

Use HPC's Graphite Gun prior to picking or impressing to loosen tight wafers or pins. Graphite is also an excellent lubricant for machines. The Graphite Guns are refillable with HPC's Bulk Graphite. It contains approximately 1/3 oz. of natural graphite. Made with real rubber!

**Bulk Graphite**  
**HPGG-16**

The GG-16 contains 1 lb. of the finest micro-spray, high quality pure graphite in a plastic drum. It provides an economical way to refill your Graphite Guns.

**Solid Plug Holder**  
**HPCPH-10**

The CPH-10 is made of hardened bar stock and holds many popular plugs; including: Arrow, Corbin, Kwikset, Lockwood, Sargent, Schlage, Weiser and Yale.

**Gateway™ Tools**  
**HPGTO**

**Features:**  
 • Holds open the dust cover on auto door locks  
 • The universal slot size covers all of the major U.S. manufacturers (GM, Ford, and Chrysler), as well as many imports (BMW, Volkswagen, Toyota, etc.)

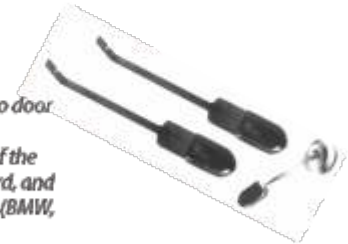
**Clip Removal Tool**  
**HPAST-3**



**Features:**  
 • For Door Handle and Window Cranks Found on GM, Ford, Chrysler, and various other vehicles

**Clip Removal Tool**  
**HPAST-4**

**Features:**  
 • The tapered end of this heavy-duty lever-type tool enters between the door and trim pad

**Lever Wedge**  
**HPLW-100**

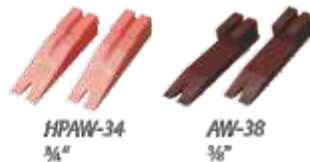
**Features:**  
 • 2 pivot points

**Ultimate Auto Wedges**

**Features:**  
 • Designed for smooth, safe insertion and will not fall into door cavities "illumination hole" holds your probe light in place at any angle

**Opener Button Clutch**  
**HP CO-87**

**Features:**  
 • This tool grabs buttons and won't let go

**Opener Skinny Twister**  
**HPCO-88**



**Features:**  
 • Holds a twist and reaches back to loop onto door handles

**The Original Slim Jim™**  
**HPCO-10**

Entry tool

**Auto Lock Cap Pliers**  
**HPALCP-10**
**Steering Column Lock Plate Compression Kit**  
**HPSWLPC-1**

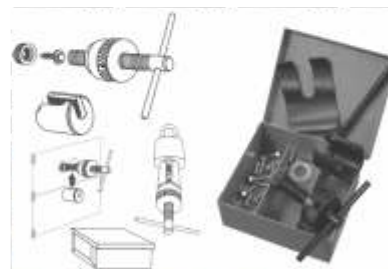
**Features:**  
 • Includes standard and metric threaded shafts and set screws, along with a longer, narrower U-bracket for air bag and telescoping columns  
 • General Motors vehicles

**Nose Puller for Safe Deposit Boxes**  
**HPNP-4B**

**Features:**  
 • Iron and bar steel set

**Door Puller & Nose Puller for Safe Deposit Boxes**  
**HPDP-7B**

**Features:**  
 • For use if lock core has been pulled or guard key has not opened door  
 • 3 different sizes of plug holes (.345", .562", .680")

## 212 SERIES COMMAND & CONTROL KEYPADS

### Features:

- 120 users
- Input trigger for Request to Exit or other open circuit contact
- All outputs programmable for latched or timed operation
- Keypad programmable
- 10-30 VDC; 12-24 /VAC – auto adjusting

### 212I Flush Mount Indoor Keypad



### Features:

- Single gang design
- Available in stainless
- 212-style – 1 SPDT 2 amp relay and three 50mA negative voltage outputs
- 1.70" x 2.60" x 1.125"

IE212I

### 212R Sealed Environmental Keypad



### Features:

- Weatherproof, self-contained metal housing
- Vandal resistant
- One piece housing suitable for wall, post, or gooseneck mounting
- Durable metal Braille keys
- Available in white
- 4 SPDT relays
- 5.25" x 3.75" x 2.5"

IE212R



Forged from experience  
Ilco provides solutions  
for today & tomorrow

## Keys



## Key Machines



## Automotive



## Hardware





## CYLINDERS

**KEY-IN-KNOB/DEADBOLT**
**COMBINATION**
**15995 Series Replacement Cylinders**
*Features:*

- Arrow D, E, F, K, Schlage B100, B200, B400, H Series deadlock
- Operates most Grade 1 & 2 knob cylinder locksets and leversets
- Screw Cap Retainer
- 04 and 26D finish
- Solid Brass Plug & Housing Screw End Cap

**ARROW**

IL15995AA-04-0B 1179  
IL15995AA-26D-0B 1179

**CORBIN**

IL15995CA-26D-KD 60  
IL15995CA-26D-0B 60  
IL15995CB-26D-0B 67  
IL15995CC-26D-KD 77  
IL15995CC-26D-0B 77  
IL15995CD-26D-0B 59A1/A2  
IL15995CE-26D-0B L4

**KWIKSET**

IL15995KS-04-0B 1176  
IL15995KS-26D-0B 1176

**LOCKWOOD**

IL15995LA-26D-0B 1004

**LORI COMPOSITE**

IL15995NB-26D-0B

**LORI 80**

IL15995UE-26D-0B

**RUSSWIN**

IL15995RA-04-0B 981R  
IL15995RA-26D-0B 981R  
IL15995RB-26D-0B D1

**SARGENT**

IL15995GA-26D-0B LA  
IL15995GB-26D-0B LA-LC  
IL15995GC-26D-0B RA-RC

**SCHLAGE**

IL15995SC-04-0B C  
IL15995SC-26D-KD C  
IL15995SC-26D-0B C  
IL15995SE-04-0B E  
IL15995SE-26D-0B E  
IL15995SX-26D-0B C-L

**WEISER**

IL15995WA-04-0B E  
IL15995WA-26D-KD E  
IL15995WA-26D-0B E

**YALE**

IL15995YA-04-0B 8  
IL15995YA-26D-KD 8  
IL15995YA-26D-0B 8  
IL15995YG-26D-0B GA

**MORTISE CYLINDERS**

ILCO® Mortise Cylinders are machined from solid bar brass. Threadsize is 1.150" x 32 UNS. Cylinder face diameter 1.360".

- 10B — Satin Bronze
- 26D — Satin Chrome
- 03 — Bright Brass
- 05 — Antique Brass

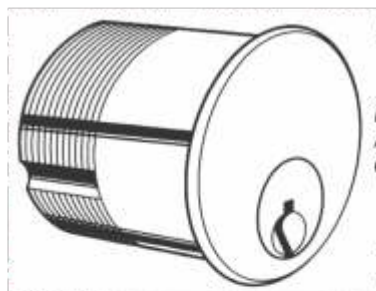
*BHMA/ANSI  
A156.5  
Grade 1*
**PINNING**

- 7165 - 5-Pin
- 7185 - 5-Pin, Drilled 6

MODEL	LENGTH	KEYWAY	CAM
IL7165SC2-10B-KA2	1"	Schlage C	Adams Rite
IL7165SC2-26D-KA2	1"	Schlage C	Adams Rite
IL7165YA2-26D-KA2	1"	Yale 8	5-Pin
IL7185CB1-26D-KA2	1 1/8"	Corbin 67	Standard
IL7185CC1-26D-KA2	1 1/8"	Corbin 77	Standard
IL7185LA1-26D-KA2	1 1/8"	Lockwood	Standard
IL7185RA1-26D-KA2	1 1/8"	Russ 981R	Standard
IL7185SC1-03-KA2	1 1/8"	Schlage C	Std+AR
IL7185SC1-10B-KA2	1 1/8"	Schlage C	Std+AR
IL7185SC1-26D-KA2	1 1/8"	Schlage C	Std+AR
IL7185SC2-05-KA2	1 1/8"	Schlage C	Adams Rite
IL7185UE2-26D-0B	1 1/8"		Lori
IL7185WA2-05-KA2	1 1/8"	Weiser E	Adams Rite
IL7185WE2-10B-KA2	1 1/8"	Weiser	Adams Rite
IL7185WE2-26D-KA2	1 1/8"	Weiser	Adams Rite
IL7185YA1-26D-KA2	1 1/8"	Yale 8	Std+AR
IL7245SC1-03-KA2	1 1/2"	Schlage C	Standard
IL7245SC1-05-KA2	1 1/2"	Schlage C	Standard

**CYLINDERS — continued**

**MORTISE DUMMY CYLINDER**

- IL7160DC-10B 1" Oil-Rubbed Bronze
- IL7160DC-26D 1" Satin Chrome
- IL7180DC-10B 1 1/8" Oil-Rubbed Bronze
- IL7180DC-26D 1 1/8" Satin Chrome



**RIM CYLINDER THUMB TURN**

- IL7011TK9-26D
- ILADA-7011TK9-26D



**TURN KNOB DISCS**

- IL704-04-11



**Features:**

- For deadlocks with standard throw
- Solid brass with spring loaded cam
- Not threaded - held in place with cylinder locking screw
- 3/16" square hub

**MORTISE CYLINDER THUMB TURN**

- IL7161TK2-10B 1" Oil-Rubbed Bronze
- IL7161TK2-26D 1" Satin Chrome
- IL7181TK2-10B 1 1/8" Oil-Rubbed Bronze
- IL7181TK2-26D 1 1/8" Satin Chrome
- IL7201TK2-26D 1 1/8" Satin Chrome



**DUMMY RIM CYLINDERS**

- IL7010DC-10 Satin Bronze
- IL7010DC-26D Satin Chrome
- IL7010DC-46 Dura Color



**7075 RIM CYLINDERS**

5-Pin cylinders are all drilled for 6-Pin



**Features:**

- Sp Rim Cylinder With Screw Cap
- W/862b Long Standard
- Tailpiece
- Bright Brass

- IL7075CA10-26D-KA2 Corbin 60
- IL7075YA10-26D-KA2 Yale 8
- IL7075SC10-26D-KA2 Schlage C
- IL7075CC10-26D-KA2 RIM CYL-CORBIN 77 CHROME
- IL7075RA10-26D-KA2 RIM CYL-RUSSWIN 981 CHROME
- IL7075SC10-10B-KA2 RIM CYL SCHLAGE C
- IL7075UE10-26D-OB RIM CYL LORI 80 CHROME

**KEY-IN-LEVER REPLACEMENT CYLINDERS**  
Corbin Russwin Knob/Unit Locksets

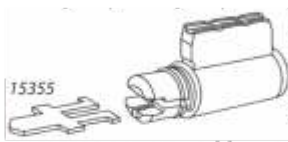

IL15355SC-26D-KD Schlage C

**Features:**

- 26D finish only
- 400, 1400, 3300, 4200, 4300, 5600 Series knob
- 300, 500 & 5200 Unit Locks
- Operates most Grade 1 & 2 knob cylinder locksets and leversets

- IL15395CA-26D-0B Corbin 60
- IL15395CC-26D-0B Corbin 77
- IL15395CE-26D-0B Corbin/ Russ L4
- IL15395GA-26D-0B Sargent LA
- IL15395NB-26D-0B Lori Composite
- IL15395RB-26D-0B Russwin D1
- IL15395SC-26D-0B Schlage C
- IL15395SE-26D-0B Schlage E
- IL15395WA-26D-0B Weiser/Falcon E
- IL15395YA-26D-0B Yale 8
- IL15395YG-26D-0B Yale GA
- IL15355SC-26D-KD Schlage C



**KEY-IN-LEVER REPLACEMENT CYLINDERS**

**Features:**

- Fits Sargent® 6 Line Lever, 10 Line Lever, 11 Line (T-Zone) Lever
- Fits Weiser single cylindrical deadbolt with tailpiece below
- 26D Finish
- Solid Brass Plug and Housing
- Screwcap Tailpiece/Plug Retainer
- Individually Polybagged, 10 per box

- IL15795CC-26D-0B Corbin 77
- IL15795GA-26D-0B Sargent LA
- IL15795GB-26D-0B Sargent LA-LC
- IL15795GC-26D-0B Sargent RA-RC
- IL15795RA-26D-0B Russwin 981R
- IL15795RB-26D-0B Russwin D1
- IL15795SC-26D-0B Schlage C
- IL15795SE-26D-0B Schlage E
- IL15795WA-26D-0B Weiser/Falcon E
- IL15795YA-26D-0B Yale 8
- IL15795YG-26D-0B Yale GA
- IL1579WDTPK-00-00 Weiser Tailpiece Kit



## CYLINDER PARTS

IL702-00-10	7015 Rim Plug Retaining Ring
IL861A-03-10	Adjustable Spring Collar-5/16"-13/32"-Bright Brass
IL861A-26D-10	Adjustable Spring Collar-5/16"-13/32"-Satin Chrome
IL861C-28-10	Aluminum Collar-3/32"Thickness-Clear Aluminum Anodized
IL861C-46-10	Collar-Cyl 3/32" DU/Solid
IL861D-28-10	Aluminum Collar-1/8"Thickness-Clear Aluminum Anodized
IL861D-46-10	Aluminum Collar-1/8"Thickness-Duracolor Brown Aluminum
IL861E-28-10	Aluminum Collar-5/32"Thickness-Clear Aluminum Anodized
IL861E-46-10	Aluminum Collar-5/32"Thickness-Duracolor Brown Aluminum
IL861F-28-10	Aluminum Collar-1/4"Thickness-Clear Aluminum Anodized
IL861F-46-10	Aluminum Collar-1/4"Thickness-Duracolor Brown Aluminum
IL861K-28-10	Aluminum Collar-3/16"Thickness-Clear Aluminum Anodized
IL861K-46-10	Aluminum Collar-3/16"Thickness-Duracolor Brown Aluminum
IL861L-28-10	Collar 7/32" AL/SOLID
IL861L-46-10	Collar 7/32" DU/SOLID
IL861Q-28-10	Aluminum Collar-3/8"Thickness-Clear Aluminum Anodized
IL861Q-46-10	Aluminum Collar-3/8"Thickness-Duracolor Brown Aluminum
IL861V-10B-10	Spring Collar Hardened - 10/Bag
IL862A-00-10	Tailpiece - Rim Extra Long 2 3/4"
IL862-00-10	Standard Break-off Tailpiece 1 3/4"
IL863-00-10	Yale Cam
IL863A-00-10	Adams Rite Cam
IL863D-00-10	Standard/Lockwood/Marks Cloverleaf Cam
IL863M-00-10	Schlage L Cam
IL863R-00-10	Lori Deadbolt Cam
IL863U-00-10	Sargent Offset
IL869-00-10	Cash Box Nut - Fits thread on Standard Mortis Cylinder
ILR2800A#2-00-10	Adams Rite SFIC Cam
ILR2800G#1-00-10	Standard SFIC Cam
ILR2800M#4-00-10	Schlage L SFIC Cam
ILR2800N#5-00-10	Sargent/Yale SFIC Cam
ILR2800S#3-00-10	Clover SFIC Cam
ILR28107-1-26D	SFIC Mort Hsg 6-7 Pin Str Cam
ILR28107-2-26D	SFIC Mort Hsg 6-7 Pin Ar Cam
ILR28207-9-26D	SFIC Rim Hsg 6-7 Pin

**702-00-10**

**861A-03-10**

**861X-XX-10**

**862-00-10**

**863-00-10**

**863A-00-10**

**863D-00-10**

**863M-00-10**

**863R-00-10**

**869-00-10**

## MISCELLANEOUS LOCKS

### BIT KEY MORTISE LOCKSET IL215-04-51



A universal replacement lock includes:  
Two (No. 209-54) knobs  
No. 751 #20 thread spindle, lock body, two trim plates, strike, screws, and two keys  
Trim plates 7" x 2-1/4"  
Strike 4" x 1" x 1/16"



**JIMMY PROOF RIM LOCK**  
IL530-53-41  
Fits Doors 1 1/4"-2 3/4"  
Backset 2 1/2"

### LETTER BOX LOCKS

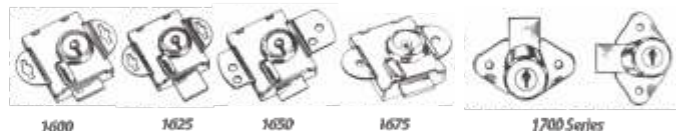

MODEL NO.	DESCRIPTION	KEYWAY
IL1600-04-11	Auth., United Florence Boxes	1270D
IL1625-04-11	1/2" bolt for Cole, Columbia, Amalgamated	1270D
IL1650-04-11	Long ear for Cole, Colubbia, Amalgamated	1270D
IL1675-04-11	Couch Boxes	1270D
IL1702-04-11 KA EB078	Drawer lock with 3/8" horizontal mount	EB078



## MISCELLANEOUS LOCKS — continued

### AUXILIARY LOCKS



**RIM DEADLOCK**  
**IL545-53-41**  
 Fits Doors 1 1/4" - 2 1/4",  
 Finish Sprayed Gold,  
 Backset 2 3/8"

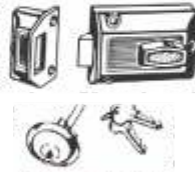

**NIGHTLATCH**  
**IL220-53-41**  
 Fits Doors 1 1/4" - 2 1/4",  
 Finish Sprayed Gold,  
 Backset 2 3/8"



**IL216-03-51**  
 Latch-Replacement / Tubular

## REPLACEMENT PARTS

### REPLACEMENT KNOBS

Replacement knobs with spindle and set screws.



IL197-03-51 Solid Brass  
 IL199A-03-51 Clear/Brass Trim

### REPLACEMENT RIM CYLINDERS



**Zinc Rim Cylinder**  
 Tubular  
 5 Pin, Diecast,  
 Keyway-KW1  
 IL605KW-04-41  
 IL605SC-04-41

### 9/32" SPINDLES

#### Straight Spindle



IL760-05	#20	3 1/2"	- 7mm x 144mm
IL760-06	#20	4 1/2"	- 7mm x 144mm
IL760-08	#20	4 1/2"	- 7mm x 144mm
IL760-13	#18	3 1/2"	- 7mm x 89mm
IL760-14	#18	4 1/2"	- 7mm x 144mm

**Spindle Caps**  
 (10 pair/pkg)  
 IL760-01

### Swivel Spindle



IL760-07	#20	4 3/4"	- 7mm x 120mm
IL760-09	#20	4 3/4"	- 7mm x 120mm
IL760-10	#20	6"	- 7mm x 152mm
IL760-15	#18	4 3/4"	- 7mm x 120mm
IL760-16	#18	4 3/4"	- 7mm x 120mm
IL760-17	#18	6"	- 7mm x 152mm

### Swivel Spindle X Caps

#### 3/8" Center



IL760-12	#20	4 3/4"	- 7mm x 120mm
IL760-19	#18	4 3/4"	- 7mm x 120mm

### Split Spindle



IL760-11	#20	2 3/4"	- 7mm x 60mm
IL760-18	#18	2 3/4"	- 7mm x 60mm

## KEY MACHINES



### Semi-Automatic Duplicator

**IL BRAVO III W/EZ-JAW**

A high quality, sturdy key duplicator designed to deliver years of service, the Bravo III with EZ-Jaw™ is a high precision, heavy-duty semi-automatic key machine. Lever operated, the Bravo III features EZ-Jaw™ four-position vise jaws, offering exceptional key gripping ability. The EZ-Jaw™ can be quickly rotated from one clamping position to the next without lifting.

#### Features:

- Wide spacing between vise jaws accommodates longer keys, and those with large heads.
- Four-position EZ-Jaw™ vise jaws securely grip residential, commercial, and automotive keys, including double-sided types, without the need for adapters

- EZ-Jaw™ vise jaws rotate from one position to another without lifting
- Carriage is spring loaded, provides consistent cutting pressure, and reduces potential for nicks
- Automatic cutter start feature; activated by raising and lowering carriage
- Depth adjustment is accomplished using a reined dial type configuration; easy to calibrate and accurate, repeatable results
- Carriage release button is activated only when the key gauges are in the down position, preventing potential contact with the cutter
- Two carriage shafts ensure sensitivity and precision in the cutting operation
- "Soft-touch" nylon deburring brush

#### Specifications:

Motor: 110V standard; 1/4 Hp capacitor start  
 Vise Jaws: EZ Jaw  
 Cutter: CU50A milling cutter, #at left side, cobalt steel  
 Dimensions: 15"W x 20" D x 10"H  
 Weight: 47 lbs.

## KEY MACHINES — continued

### TWISTER II ILTWISTERII

*Twister II provides convenience, accuracy and precision at a modest price point and allows for expansion of capabilities with the optional accessories.*

*Lightweight, compact design with a small footprint makes this duplicator a perfect choice for mobile applications. The lockable carriage prevents movement during transport.*



**Features:**

- Two axis movement on ball guides for smooth, easy operation
- Spring loaded tracer point guides and facilitates self-centering of cuts on dimple keys
- Wide transparent safety shield
- Tracer point adjustment for depth alignment and provides for adjustment of worn keys
- Replaceable jaw surface plates for quick economical repair
- Laser and dimple cutters and tracers included
- LED light illuminates working area
- Master safety switch with separate cutter motor switch
- Optional cutters, tracers, and accessories expand capabilities

### FUTURA PRO ILFUTURAPRO

**Technical Specifications:**

**Power Supply:** 90/264V-50/60Hz, Rated Current 5.5Amp

**Motor:** 24VDC, 1585 rpm (edge), 12100 rpm (laser/dimple)

**Cutters:** Laser - D747838ZB U01W Carbide

**Dimple - D742867ZB 01D HSS**

**Edge - D747276ZR 01F TiCN coating**

**Dimensions:**

**Width:** 12.52" (318mm)

**Depth:** 16.26" (413mm)

**Height:** 20.47" (522mm), 13.38" (340mm)

without tablet

**Weight:** 42 lbs (19 kg)



*A unique electronic key cutting machine combining two cutting stations in one user-friendly device that can cut a variety of key styles in one innovative machine.*

*A powerful machine for professional key cutters yet also ideal for inexperienced key cutters thanks to the software guided procedures throughout the cutting process.*

**Features:**

- Shortcut function for vehicle key cutting code searches eliminates manual entry
- LED color changing lights indicate the status of the cutting process
- Integrated cutter holder keeps work station efficient and orderly.
- Built-in hood accessory tray for quick access to tools and/or keys
- Removable tablet stand can be locked onto the machine hood or placed on the counter
- Two USB ports; one for tablet recharge and one for the tethering connection so the machine and tablet remain connected and operational even when the Wi-Fi connection is unstable or lost. The second USB port can also be used to connect the USB flash drive (supplied) to import code tables or for machine software updates.
- Guided, step-by-step updating procedures
- Kreate-A-Key™ and Instacode Interface included

ILSPEED 040  
ILSPEED 044  
ILSPEED 045  
ILSPEED 046

KEY MACHINE X AUTO/MANUAL  
KEY MACHINE X SEMI-AUTOMATIC  
KEY MACHINE X MANUAL  
KEY MACHINE X MANUAL FLAT KEYS



ILSPEED 040

KEY MACHINE X AUTO/MANUAL



ILSPEED 044

KEY MACHINE X SEMI-AUTOMATIC



ILSPEED 045

KEY MACHINE X MANUAL



ILSPEED 046

KEY MACHINE X MANUAL FLAT KEYS



## KEY MACHINES PARTS

### BRUSHES

Wire Brush



Nylon Brush



Bravo Brush



MODEL NO.	DESCRIPTION	
<b>Wire Brush</b>		
<b>IL12-10A</b>	Replacement for most ILCO UNICAN, Taylor Lock, and Dominion Lock machines. 3" diameter with 1/2" arbor hole	
<b>Soft Touch (Nylon) Brush</b>		
<b>IL814-00-51</b>	3"	Replacement for most ILCO UNICAN, Taylor Lock, and Dominion Lock machines. 3" diameter with 1/2" arbor hole
<b>IL815-00-51</b>	6"	
<b>IL816-00-51</b>	4"	
<b>Tynex Brush For Bravo USA</b>		
<b>ILD301840ZZ</b>	Bravo Brush (Tynex)	
<b>Brush For Bravo III</b>		
<b>ILD925102ZB</b>	Brush Replacement for Bravo III	

### CUTTERS



Fine Milling



Milling



Side Milling Slotter



Slotter

MODEL NO.	TYPE	MATERIAL	DIA.	THICK.	HOLE DIA.
ILD700875ZZ	Milling Cutter/Bravo-USA	H.S.S.	3.125"	.197	.0625"
ILD705488ZB					
ILCU5	Milling	T.S.	2.25"	.250	.50"
ILCU50A	Milling / Bravo II & III	C.	3.15"	.197	.63"
ILSMS30	Side Milling Slotter	H.S.S.	2.375"	.030"	.50"
ILSMS45	Side Milling Slotter	H.S.S.	2.375"	.045"	.50"
ILX23MC	Milling	H.S.S.	2.375"	.093"	.50"
IL12	Slotter	H.S.S.	2.063"	.045"	.50"
IL23RF	Fine Milling	T.S.	2.25"	.250"	.50"
IL27	Slotter	H.S.S.	2.25"	.045"	.50"
IL34MC	Milling	H.S.S.	2.25"	.250"	.50"
ILP-CU20	Milling	Fits 044, 040, 020, 024A, 024B			
<b>H.S.S. - High Speed Steel</b>		<b>T.S. - Tool Steel</b>	<b>C. - Cobalt</b>		

#### For 025 Machines

IL1103264A Nut, Wing (2/Pkg.)

#### For 2584 Machines

IL1-59 Bearing, Thrust

#### MASTER KEY SELECTOR



ILMKS-1 CD

#### Z-KEYWAY ADAPTER



ILBD0699XXXX

#### MICRO-DIAL CALIPER



IL884-00-41

## ALUMINUM STORE FRONT PARTS

### EXIT DEVICE PARTS

ILDA-267 Dogging Assembly  
 ILEC-267 End Cap Pkg for 129  
 ILEC-269 End Cap Pkg for 128



## DEADBOLTS

### MORTISE CYLINDER DEADBOLT

*Less Cylinders*

• *Designed for heavy duty use: Accepts all US Mortise cylinders with 1.150 X 32 UNS threads*

### 4510 Series Single Cylinder Standard Profile Roses



**2 3/8" Backset**

IL4513-04-26D-0 Satin Chrome

**2 3/4" Backset**

IL4514-04-26D-0 Satin Chrome  
IL4516-04-26D-0 Satin Chrome DI

### Tailpiece, Thumbturn



IL4500-82-2007

### 4520 Series Double Cylinder Standard Profile Roses

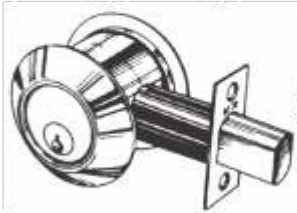

**2 3/8" Backset**

IL4523-04-26D-0 Satin Chrome

**2 3/4" Backset**

IL4524-04-26D-0 Satin Chrome  
IL4526-04-26D-0 Satin Chrome DI



IL774F-03-11  
Strike Mort. 5 1/2"

### Less Faceplates

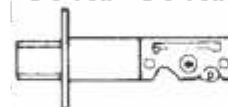

IL4500-26D-5000 2 3/8"  
IL4510-26D-5001 2 3/4"

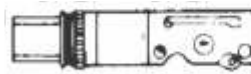

IL4540-26D-5014 DI, 2 3/8" 26D  
IL4550-26D-5001 DI, 2 3/4" 26D

DI = Drive In



IL4500-26D-5017 Rose, Standard for 4500

### Faceplates With Screws



IL4500-26D-5012  
1" / 26D

IL4510-26D-5012  
1 1/8" / 26D

## MISC KEY BLANKS

IL1028L	KEY BLANK NS	ILH94-PT	TRANSPONDER KEY FORD
ILB97-PT	TRANSPONDER KEY BUICK	ILHD106-PT	TRANSPONDER KEY ACURA
ILB97-PT5	TRANSPONDER KEY BUICK	ILHD106-PT5	TRANSPONDER KEY ACURA
ILB99-PT	TRANSPONDER KEY GM	ILHD111-PT	TRANSPONDER KEY ACURA
ILB99-PT5	TRANSPONDER KEY BUICK/CAD	ILHD113-PT	TRANSPONDER 2007-08 HONDA
ILB120-PT	TRANSPONDER KEY GM	ILHO01-PT	TRANSPONDER KEY HONDA
ILB103-PT	TRANSPONDER KEY PONTIAC	ILHO01T5	TRANSPONDER KEY HONDA
ILB103-PT5	TRANSPONDER KEY PONTIAC	ILHO03-PT	TRANSPONDER HONDA/ACURA
ILB111-PT	TRANSPONDER KEY	ILHO05-PT	TRANSPONDER HONDA HS
ILB112-PT	TRANSPONDER KEY 03-07 CTS	ILHU46T2	TRANSPONDER KEY CADILLAC
ILB114-PT	TRANSPONDER 2008-09 VUE	ILHU66AT6	TRANSPONDER KEY AUDI
ILB114R-PT	TRANSPONDER 2008-09 VUE	ILHU66T24	TRANSPONDER KEY VW JETTA
ILB119-PT	TRANSPONDER KEY GM	ILHU66T6	TRANSPONDER KEY VW
ILDAT17T13	TRANSPONDER SUBARU	ILHY20-PT	TRANSPONDER KEY HYUNDAI
ILDWO4CT6	TRANSPONDER CHEVROLET SPARK	ILHYN14RT14	TRANSPONDER KEY HYUNDAI
ILDWO5RT5	TRANSPONDER KEY DAEWOO	ILKK7-PT	TRANSPONDER KIA AMANTI HS
ILDWO5T5	TRANSPONDER KEY DAEWOO	ILKK9-PT	TRANSPONDER KIA SIDEWINDR
ILEB3-A-Y160	ELECTRONIC KEY BLADE ONLY	ILMAZ24R-PT	TRANSPONDER MAZDA
ILEB3-B-H72	ELECTRONIC KEY BLADE ONLY	ILMAZ24RT5	TRANSPONDER KEY MAZDA
ILEB3-C-H73	ELECTRONIC KEY BLADE ONLY	ILMIT12-PT	TRANSPONDER KEY
ILEB3-D-H84	ELECTRONIC KEY BLADE ONLY	ILMIT14-PT	TRANSPONDER KEY
ILEB3-E-TOY43	ELECTRONIC KEY BLADE ONLY	ILMIT17A-PT	TRANSPONDER KEY MITSU
ILEB3-F-TOY48	ELECTRONIC KEY BLADE ONLY	ILMIT8-PT	TRANSPONDER KEY MITSU
ILEB3-G-TOY40	ELECTRONIC KEY BLADE ONLY	ILMIT9-PT	TRANSPONDER KEY MITSU
ILEB3-H-NI02	ELECTRONIC KEY BLADE ONLY	ILNI01T	TRANSPONDER KEY NISSAN
ILEB3-J-MAZ24	ELECTRONIC KEY BLADE ONLY	ILNI02T	TRANSPONDER KEY NISSAN
ILEB3-K-MIT8	ELECTRONIC KEY BLADE ONLY	ILNI04T	TRANSPONDER KEY NISSAN &
ILEB3-L-MIT9	ELECTRONIC KEY BLADE ONLY	ILNI05T	TRANSPONDER NISSAN EMERG
ILEB3-M-MIT14	ELECTRONIC KEY BLADE ONLY	ILNSN11T2	TRANSPONDER KEY N155SAN-
ILEB3-N-SUB1	ELECTRONIC KEY BLADE ONLY	ILPT04-PT	TRANSPONDER GM PK3
ILEB3-P-SUB4	ELECTRONIC KEY BLADE ONLY	ILPT04-PT5	TRANSPONDER 04 GRAND PRIX
ILEB3-R-B111	ELECTRONIC KEY BLADE ONLY	ILSUB4-PT	TRANSPONDER 2005-08
ILEB3-S-HO03	ELECTRONIC KEY BLADE ONLY	ILTOY40BT4	TRANSPONDER LEXUS/TOYOTA
ILEB3-T-Y170	ELECTRONIC KEY BLADE ONLY	ILTOY43AT4	TRANSPONDER KEY TOYOTA
ILEB3-V-HU100	ELECTRONIC KEY BLADE ONLY	ILTOY44D-PT	TRANSPONDER KEY TOYOTA
ILEB3-W-B114R	ELECTRONIC KEY BLADE ONLY	ILTOY44G-PT	TRANSPONDER TOYOTA 2011
ILEB3-Y-B99	MODULAR BLADE F/EHC3 ONLY	ILTOY48BT4	TRANSPONDER KEY LEXUS
ILEH3	EL KEY HEAD TEXAS INSTR	ILTOY50-PT	TRANSPONDER KEY LEXUS
ILEH3C	CHIPLESS HEAD	ILTOY57-PT	TRANSPONDER KEY
ILEH3P	EL KEY HEAD PHILIPS	ILX279	KEY BLANK NP X279 KA34
ILEK3-H84	ELECTRONIC KEY FORD	ILX280	KEY BLANK NP X280 HY15
ILEK3RT	HEAD REMOVAL TOOLttt	ILX281	KEY BLANK NP X281 HY16
ILGTH	GLASS TRANSPONDER HEAD	ILX282	KEY BLANK NP X282 HY17
ILH72-PT	TRANSPONDER KEY FRD 8-CUT	ILY160-PT	TRANSPONDER KEY CHRYSLER
ILH73-PT	TRANSPONDER KEY FORD-10	ILY162-PT	TRANSPONDER KEY 2001 CHRY
ILH74-PT	TRANSPONDER KEY LINCOLNLS6 & LS8 1999	ILY164-PT	TRANSPONDER KEY
ILH86-PT	TRANSPONDER KEY FORD-FOCUS 2000	ILY170-PT	CHRY EMERGENCY POD KEY









DOOR CLOSER BRACKETS & DROP PLATES





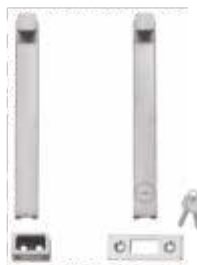

 <p><b>Cylinder Pull Plate</b> - Narrow stile with rim cylinder/ cup/collar IT54P3A-690</p>	<p><b>ELR Kits</b> Adams Rite 8800 ITLR100ARK</p> 	 <p>Von Duprin 99 ITLR100VDK</p>
<p>850/880/8050 <b>Top Jamb Bracket</b> ITTJB-54-AL ITTJB-54-DU</p> 	<p>850/880/5000/8000 IT525-AL</p> 	<p>850/880/8050 <b>Flat Drop Plate</b> IT547-AL IT547-DU</p> 
<p>44CI <b>Drop Plate Pull Side</b> IT44-18-AL IT44-18-DU</p> 	<p>44CI <b>Drop Plate Push Side</b> IT44-18-AL IT44-18-DU</p> 	<p>44CI <b>Drop Plate Push Side</b> IT44-18J-AL IT44-18J-DU</p> 
<p>44CI <b>Pa Drop Plate Parallel Arm</b> IT44-18PA-AL IT44-18PA-DU</p> 	<p><b>Door Closer Regular Arm</b> Size 4  IT854 X 689</p>	<p>IT44-18G-AL 4400 Drop Plate Push Side IT44-18G-DU 4400 Drop Plate Push Side</p>



**DOOR ACCESSORIES**

Product No.	Product	Description
IVCOR7G-US26D		<p><b>COR7G - 7" Projection</b></p> <ul style="list-style-type: none"> <li>• Use on pairs of doors with astragal on active door up to 4'</li> <li>• With astragal, inactive door up to 3' 4"</li> <li>• With astragals, both doors up to 2' 10"</li> </ul>
IVCOR9G-US26D		<p><b>COR9G - 9" Projection</b></p> <ul style="list-style-type: none"> <li>• Use on pairs of doors with astragal on active door over 4'</li> <li>• With astragal, inactive door over 3' 4"</li> <li>• With astragals, both doors over 2' 10"</li> </ul>
IVFB31P-12-MD-US32D	 <p>FB31P</p> <p>FB458</p>	<p><b>FB31P Pair - Top and Bottom Bolts / Automatic Flush Bolts – Metal Doors</b></p> <ul style="list-style-type: none"> <li>• Both bolts are nonhanded, but are not identical. The top bolt has no spring tension, resulting in lower actuation force with a smoother operation.</li> <li>• Body Size: 1" Wide x 6 3/4" Long x 2" Deep</li> <li>• UL Listed 3 hours on 8' 0" x 10' 0" Opening</li> </ul>
IVFB458-12-MD-US26D		<p><b>FB458 - Top or Bottom Bolt / Manual Flush Bolt – Metal Doors</b></p> <ul style="list-style-type: none"> <li>• Simplified installation in metal frames. Round bolt head requires only a punched hole. Use of strike optional</li> <li>• Special design of guide and flat sided bolt tip to prevent bolt rotation</li> <li>• Body Size: 1" Wide x 6 3/4" Long x 1 1/4" Deep</li> <li>• UL Listed 3 hours on 8' 0" x 10' 0" Opening</li> </ul>
IVSB453-8-TB-US2C		<p><b>SB453 - Surface Bolt</b></p> <ul style="list-style-type: none"> <li>• Surface Bolt has 1 3/16" throw for maximum security</li> <li>• Strong tension springs prevent creep</li> <li>• Ideal for all types of doors</li> <li>• Available 8" length</li> <li>• Units packed with standard screws for added security</li> <li>• Units packed with both a universal top strike (T) and a mortise bottom strike (B).</li> <li>• Constructed of heavy duty steel</li> <li>• 8" Bolt are UL listed</li> </ul>
IVSB453-8-TB-US10B		
IVSB1630-TBL-1289-US2G		<p><b>SB1630TBL - Locking Surface Bolt</b></p> <ul style="list-style-type: none"> <li>• Standard Surface Bolt has 1" throw for maximum security</li> <li>• Ideal for all types of doors</li> <li>• Full concealed mounting prevents vandalism</li> <li>• Unit locks in both the up and the down positions. Furnished with 2 keys</li> <li>• With wood &amp; machine screws; top &amp; bottom strikes</li> <li>• Body Size: 8" Long x 3/4" Wide x 1/4" Thick</li> <li>• 1630 Series is constructed of heavy duty steel</li> <li>• Locking Surface Bolt Keyed Alike #1395</li> </ul>
IVFS555-5-SP28		<p><b>FS555 - Kick Down Holders and Parts</b></p> <ul style="list-style-type: none"> <li>• Units provide an economical method to hold open doors.</li> <li>• Cast of durable iron.</li> <li>• Non-marring rubber shoes have corrugated bottoms to provide secure grip. Rubber shoe is securely fastened with screw. When worn, shoes are easily replaced.</li> <li>• FS555 for door-to-floor clearances up to 3"</li> <li>• FS555 meets ANSI/BHMA 156.16, L11391</li> <li>• FSPART.1052 - Rubber Threaded</li> <li>• FSPART.1074 - Rubber with Screw</li> </ul>
IVFS555-5-SP4		
IVFSPART.1052		
IVFSPART.1074		

## DOOR ACCESSORIES

Product No.	Product	Description
IVFS436-US26D	<b>FS436</b> 	<b>FS436 - Floor Stops – Dome</b> <ul style="list-style-type: none"> <li>• For doors without threshold.</li> <li>• Heavy-Duty Cast Dome Stops constructed of brass, bronze or aluminum.</li> <li>• Gray, non-marring rubber bumper.</li> <li>• Packed with wood screw and plastic anchor.</li> </ul>
IVR435-1/4" US27		
IVWS404CVX-US26D		<b>WS404CVX - Wall Door Stop</b> <ul style="list-style-type: none"> <li>• 1" Base Wall Stop</li> <li>• Totally concealed mounting discourages vandalism or tampering</li> <li>• Unit furnished with grey convex rubber bumper</li> <li>• Packed with sheet metal screw, rawl plug and brad</li> </ul>
IVWS407CCV-US3	<b>WS407CCV</b> 	<b>WS407CCV - Wall Bumper</b> <ul style="list-style-type: none"> <li>• Unit is designed with a concave rubber bumper which avoids damage to locks with projecting buttons and is packed with screw and drywall anchor</li> <li>• 2 1/2" diameter x 3/8" base; 1" overall projection</li> </ul>
IVWS407CCV-US32D		<b>SR64 - Door Silencer</b> <ul style="list-style-type: none"> <li>• For use on metal frames, featuring pneumatic design that forms an air pocket to absorb shock and reduce noise of door closing</li> <li>• Tamper-proof once installed on the frame</li> </ul>
IVSR64		
IVDP1-US26D	<b>DP1</b> 	<b>Dust Proof Strike</b> <ul style="list-style-type: none"> <li>• DP1 and DP2 are designed for use with the bottom bolt of all Ives flush bolts.</li> <li>• Spring-loaded plunger returns flush to floor or threshold level anytime flush bolt is retracted, eliminating need to clean standard floor strikes.</li> </ul>
IVDP2-US26D	<b>DP2</b> 	
IVCOR52-US28		<b>Bar Coordinator</b> <ul style="list-style-type: none"> <li>• For opening with 62" - 92" with a common application of pair of 3' 0" doors</li> <li>• 1 1/2" x 5/8" steel tubing</li> <li>• Designed for use on pairs of doors when one door needs to close before the other</li> </ul>

### SMART CLONE



The blade of the **SMART CLONE** transponder key separates from the electronic key bow so it can be easily replaced in case of damage or miscut.

#### CLONE THE UNCLONABLE WITH THE JET SMART CLONE

Jet Hardware was the first to bring the Transponder business to the Locksmith. Now, with the Jet "SMART CLONE" the once "UNCLONABLE" Ford Transponder Keys now can be duplicated in your customers shops like any other Transponder Key !

#### VEHICLES NOT REQUIRED

Locksmiths will have no more wasted time working with the on-board systems. Only one key is required eliminating the need for the more costly diagnostic equipment. The **H72-N-PHT** key may be duplicated in less than a minute! It will also clone similar cloneable key blanks from other manufacturers.



SCLONE-1

#### TRANSPONDER KEYS

JTB103-PHT	GM
JTB97-PHT	GM
JTB99-PHT	GM
JTB107-N-PHT	GM
JTDA31-N-PHT	Datsun
JTHD106-N-PHT	Honda/Acura
JTHD110-N-PHT	Honda
JTH72-N-PHT	Ford
JTH72-PHT	Ford
JTH86-PHT	Ford
JTH91-PHT	Ford
JTINFQ45-N-PHT	Inniti
JTMAZ24-N-PHT	Mazda
JTS30FD-N-PHT	Ford
JTSR9-N-PHT	Subaru
JTTR47-N-PHT	Toyota
JTT10HF54-N-PHT	Catera
JTY165-PHT	Chrysler

#### REPLACEMENT BLADES

JTDA34-N-B	Nissan
JTH72-N-B	Ford
JTMIT12-N-B	Mitsubishi
JTMIT13-N-B	Mitsubishi
JTMZ34-N-B	Mazda
JTSCH-5	Head 1st Generation
JTSCH-4	Head 2nd Generation
JTS30FD-N-B	2nd Gen Tibbe
JTSR8-N-B	Subaru
JTSR9-N-B	2nd Gen H.S.
JTTR47-N-B	Toyota
JTTR48-N-B	Lexus
JTTR49-N-B	Lexus
JTTR51-N-B	Toyota
JTTR60-N-B	Lexus
JTY160-N-B	Chrysler

### HARLEY-DAVIDSON KEY BLANKS

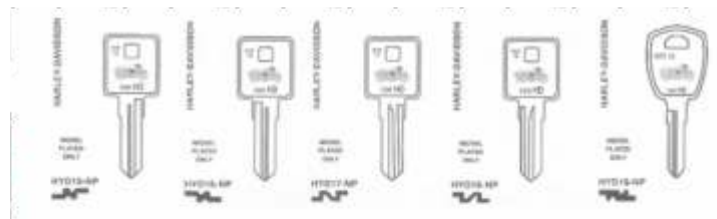

JTHYD15-NP	KEY BLANK HARLEY-DAVIDSON	10/Bag 50/Box
JTHYD16-NP	KEY BLANK HARLEY-DAVIDSON	10/Bag 50/Box
JTHYD17-NP	KEY BLANK HARLEY-DAVIDSON	10/Bag 50/Box
JTHYD18-NP	KEY BLANK HARLEY-DAVIDSON	10/Bag 50/Box
JTHYD19-NP	KEY BLANK HARLEY-DAVIDSON	10/Bag 50/Box



## KEY BLANKS

JT101C-NS	SILVERLINE KEY BLANK	JTKW1-385	KEY BLANK U.S. MARINES
JT1A1A1-NS	KEY BLANK SILVERLINE	JTKW1-390	KEY BLANK U.S. AIR FORCE
JT1A1B1-NS	KEY BLANK SILVERLINE	JTKW1-395	KEY BLANK U.S. ARMY
JT1A1C1-NS	KEY BLANK SILVERLINE	JTKW1-400	KEY BLANK U.S. NAVY
JT1A1D1-NS	KEY BLANK SILVERLINE	JTKW1-405	KEY BLANK U.S. COASTGUARD
JT1A1E1-NS	KEY BLANK SILVERLINE	JTMAZ24-N-PHT	TRANSPONDER KEY
JT1A1F1-NS	KEY BLANK SILVERLINE	JTMIT12-N-B	REPL BLADE 3RD GENERATION
JT1A1G1-NS	KEY BLANK SILVERLINE	JTMIT13-N-B	REPL BLADE 3RD GENERATION
JT1A1H1-NS	KEY BLANK SILVERLINE	JTMZ34-N-B	REPL BLADE 3RD GENERATION
JT1A1J1-NS	KEY BLANK SILVERLINE	JTS30FD-N-B	REPL BLADE 3RD GEN TIBBE
JT1A1K1-NS	KEY BLANK SILVERLINE	JTS30FD-N-PHT	TRANSPONDER KEY FORD
JT1A1L1-NS	KEY BLANK SILVERLINE	JTSC1-214	KEY BLANK LILY
JT1A1M1-NS	KEY BLANK SILVERLINE	JTSC1-216	KEY BLANK PAISLEY
JT1A1N1-NS	KEY BLANK SILVERLINE	JTSC1-252	KEY BLANK BLUE FLORAL
JT1A1Q1-NS	KEY BLANK SILVERLINE	JTSC1-253	KEY BLANK FLORAL BURST
JT1A1TB1-NS	KEY BLANK SILVERLINE	JTSC1-300	KEY BLANK JUNGLE CAT
JT1A1TD1-NS	KEY BLANK SILVERLINE	JTSC1-305	KEY BLANK OLD GLORY
JT1A1TE1-NS	KEY BLANK SILVERLINE	JTSC1-310	KEY BLANK ZEBRA
JTB106-NP	KEY BLANK SATURN	JTSC1-320	KEY BLANK CAMOUFLAGE
JTCON1	KEY BLANK GM CONSOLE	JTSC1-335	KEY BLANK DALMATIAN
JTH75-NP	KEY BLANK FORD 8 CUT	JTSC1-340	KEY BLANK BETSY ROSS
JTHY16-NP	KEY BLANK HYUNDAI 2006	JTSC1-BB	BIG BOW SCHLAGE C 5-PIN
JTHY16-PH	KEY BLANK HYUNDAI 2006	JTSC4-BB	BIG BOW SCHLAGE C 6-PIN
JTHY17-NP	KEY BLANK HYUN'07 ELANTRA	JTSC9-BB	BIG BOW SCHLAGE E 6-PIN
JTHY17-PH	KEY BLANK HYUN'07 ELENTRA	JTWR5-214	KEY BLANK LILY
JTKA33-NP	KEY BLANK KAWASAKI NINJA	JTWR5-216	KEY BLANK PAISLEY
JTKW1-214	KEY BLANK LILY	JTWR5-252	KEY BLANK BLUE FLORAL
JTKW1-216	KEY BLANK PAISLEY	JTWR5-253	KEY BLANK FLORAL BURST
JTKW1-252	KEY BLANK BLUE FLORAL	JTWR5-300	KEY BLANK JUNGLE CAT
JTKW1-253	KEY BLANK FLORAL BURST	JTWR5-305	KEY BLANK OLD GLORY
JTKW1-300	KEY BLANK JUNGLE CAT	JTWR5-310	KEY BLANK ZEBRA
JTKW1-305	KEY BLANK OLD GLORY	JTWR5-320	KEY BLANK CAMOUFLAGE
JTKW1-310	KEY BLANK ZEBRA	JTWR5-335	KEY BLANK DALMATIAN
JTKW1-320	KEY BLANK CAMOUFLAGE	JTWR5-340	KEY BLANK BETSY ROSS
JTKW1-335	KEY BLANK DALMATIAN	JTWR7-NP	WEISER SMART KEY KW1 KWY
JTKW1-340	KEY BLANK BETSY ROSS		

## KEY MACHINE

JT9000B-110V  
JT9000B-12V

### PARTS

JT9000-BRUSH  
JT9000-MC  
JT9000B-MOUNT



JT9000B  
MANUAL KEY MACHINE

JT9000B-MOUNT

## TRANSPONDER KEYS

JMTP02FO-15DC.P  
 JMTP03GM-27.P  
 JMTP03GM-28.P  
 JMTP03GM-43.P  
 JMTP03HOND-21.P  
 JMTP03HOND-31.P  
 JMTP06FO-150C.PD  
 JMTP07TOYO-15.P  
 JMTP05HOND-21.P  
 JMTP05ME-HM.P1  
 JMTP08HU-HAA.P1  
 JMTP08HU-HAA.P  
 JMTP12CHR-15.P1  
 JMTP12HOND-31.P  
 JMTP12MIT-8D.P2  
 JMTP12CHR-15.PC  
 JMTP12DAT-15.P3  
 JMTP12GM-37.P  
 JMTP13DAT-6.P2  
 JMTP19DAT-15.P4  
 JMTP21CHR-15.PG  
 JMTP23HU-HAA.P1  
 JMTP25HU-HAA.P  
 JMTP28SUB2.P  
 JMTP29TOYO-36.P  
 JMTP30TOYO-15.P

TRANSPONDER H72PT  
 TRANSPONDER B97PT  
 TRANSPONDER B99PT  
 TRANSPONDER B103PT  
 TRANSPONDER HD106PT  
 TRANSPONDER HO01  
 TRANSPONDER H74PT/H86PT  
 TRANSPONDER TOY43AT4  
 Honda HD106PT5 Cloneable  
 Dodge Sprinter Cloneable  
 Porsche 968/Cayenne  
 Audi  
 Chry Y170PT  
 Honda/Acura  
 Mits GAL/LAN/OUT 2007+  
 TRANSPONDER Y164PT  
 TRANSPONDER NI04T  
 TRANSPONDER B111PT  
 Nissan Maxima 1999 OBP  
 TRANSPONDER NI02T  
 TRANSPONDER Y160PT  
 VW Can System  
 Audi Can System  
 Subaru Impreza 08-09 OBP  
 Lexus Texas Crypto  
 Toyota OBP

JMTP30FO-30D.P  
 JMTP33FO-24.P  
 JMTP33MAZ-11D.P2  
 JMTP34TOYO-15.P  
 JMTPG1  
 JMTPX1  
 JMTPX1FO-15D.P  
 JMTPX1FO-16.P  
 JMTPX1TOYO-15.P  
 JMTPX1TOYO-18.P  
 JMTPX1TOYO-30.P  
 JMTPX2  
 JMTPX2CHR-15.PG  
 JMTPX2DAT-15.P3  
 JMTPX2DAT-15.P4  
 JMTPX2FO-15D.P  
 JMTPX2FO-30D.P  
 JMTPX2MAZ-11D.P2  
 JMTPX2MIT-12.P2  
 JMTPX2MIT-18.P  
 JMTPX2MIT-8D.P2  
 JMTPX2SUB-2.P  
 JMTPX2SUB-3.P2  
 JMTPX2TOYO-15.P  
 JMTPX2TOYO-36.P  
 JMTPX5

Transponder H92PT  
 FORD FOCUS 2012-13 HS SM  
 Transponder MZ34PT  
 TRANSPONDER TOY44GPT  
 Toyota G Texas 80 Bit Chip  
 JMA Transponder Chip Only  
 Ford H72PT Cloneable  
 Ford H73PT Cloneable  
 Toyota TOY43AT4 Cloneable  
 Lexus Long Blade TOY40BT4  
 Lexus Short Blade TOY48BT4  
 JMA Transponder Chip Only  
 Chrysler Y160PT Cloneable  
 Nissan NI01PT Cloneable  
 Ininiti NI02PT Cloneable  
 Ford H74PT Cloneable  
 Ford H84PT Cloneable  
 Mazda Cloneable  
 Mitsu MIT8PT MIT12PT  
 Mitsu MIT9PT MIT13PT  
 Mitsu MIT14PT Cloneable  
 Subaru Impreza Cloneable  
 Subaru SUB4PT Cloneable  
 Toyota TOY44DPT Cloneable  
 Lexus Cloneable  
 TPX5 Wedge Transponder Chip

## CHIPLESS TRANSPONDER KEYS

JMTP00CHR-15.P1  
 JMTP00CHR-15.PC  
 JMTP00CHR-15.PG  
 JMTP00DAT-15.P3  
 JMTP00FO-15DC.P  
 JMTP00FO-24.P  
 JMTP00FO-30D.P  
 JMTP00FO-6.P  
 JMTP00GM-28.P

Y170PT  
 Y164PT Tan  
 Y160PT Gray  
 N101T N102T  
 H72./H74./H86PT  
 HU101T17  
 H84PT 599114  
 Ford Transit  
 B99PT B112PT

JMTP00GM-37.P  
 JMTP00HOND-21.P  
 JMTP00HOND-31.P  
 JMTP00MAZ-11D.P  
 JMTP00MAZ-11D.P2  
 JMTP00MIT-18.P  
 JMTP00MIT-8D.P1  
 JMTP00MIT-12.P2  
 JMTP00TOYO-15.P

PT04PT B111PT  
 HD106PT HD111PT  
 Ford Transit  
 MAZ24RT5  
 Mazda  
 MIT9PT MIT13PT  
 Mitsubishi  
 Mitsubishi  
 TOY43AT4 TOY44DT

## TRANSPONDER CHIPS

### Transponder Chips

JMTP05  
 JMTP33  
 JMTPX5  
 JMTPX1  
 JMTPX2  
 JMTPX4  
 JMTPX5



JMTPX5W

## ENCRYPTED KEYS

### Philips Encrypted Keys

JMTPX4CHR-15.P1  
 JMTPX4CHR-15.PC  
 JMTPX4DAE-4.P2  
 JMTPX4DAT-15.P3  
 JMTPX4DAT-15.P4  
 JMTPX4GM-37.P  
 JMTPX4HOND-31.P  
 JMTPX4HY-11D.P1  
 JMTPX4MIT-18.P  
 JMTPX4MIT-8D.P2  
 JMTPX4OP-11.P1

Chrysler Y170PT Cloneable  
 Chrysler Y164PT Cloneable  
 GM B114PT Cloneable  
 Nissan N104T Cloneable  
 Ininiti N104T Cloneable  
 GM B111PT Cloneable  
 Honda HO03PT Cloneable  
 HY/KIA HYN14RT14 Cloneable  
 Mitsu MIT16APT Cloneable  
 Mitsu MIT17APT Cloneable  
 GM Cloneable



## TRS-5000 EVO CLONING MACHINE

### TRS-5000 EVO CLONING MACHINE



JMTRS-5000-EVO

Clone 85% of the vehicles on the road with the most complete and versatile Transponder System available. Designed to detect, read and clone transponder keys equipped with Texas Instruments® and Phillips® fixed code and crypto transponders on to JMA's proprietary TPX1, TPX2 and TPX3 glass tag transponders. Stand alone operation, requires no internet or PC connection. Free software updates keep your machine up to date and cloning the latest technologies. PC software, allows for database creation and easy automatic updates.

Specification	Description
Size	6 1/2"W x 7"L x 3 1/2"H
Weight	1.21 lbs
Power	12 VDC (AC to DC converter provided)
Language	English, Spanish, Italian, German, French
PC Connection	Serial Connection and USB
JMA Software	Included

## REMOTE SHELLS



**Chrysler Dodge Jeep**  
JMCHR-1.RKE 4-Button  
JMCHR-2.RKE 3-Button



**Toyota**  
JMTOYO-1.RKE 3-Button



**GM**  
JMGM-1.RKE 4-Button  
JMGM-3.RKE 3-Button  
JMGM-4.RKE 3-Button  
JMGM-5.RKE 3-Button  
JMGM-6.RKE 2-Button  
JMGM-7.RKE 4-Button



**Honda**  
JMHOND-1.RKE 4-Button  
JMHOND-2.RKE 3-Button



**Nissan**  
JMNIS-1.RKE 4-Button  
JMNIS-2.RKE 3-Button  
JMNIS-3.RKE 4-Button



**Ford**  
JMFO-1.RKE 4-Button  
JMFO-2.RKE 3-Button



**Mazda**  
JMAAZ-1.RKE 3-Button  
JMAAZ-2.RKE 4-Button



### 900 SERIES



**Features:**

- Mechanical pushbutton access control
- All metal; cast front housing; force-proof clutch-protected thumbturn
- Backset: 2 9/16" for out-swing doors; 2 1/2" for in-swing doors
- Egress by interior thumbturn
- Deadbolt must be manually relocked
- Combination changed without removal
- Reversible Handing

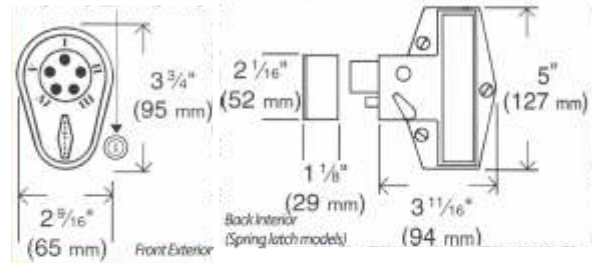

Product Number	Bolt/Latch	Door Thickness
KA9040000-04-41	Deadbolt	1 3/8" - 2 1/8"
KA9040000-26D-41	Deadbolt	1 3/8" - 2 1/8"
KA9190000-26D-41	Deadlocking Latch	1 3/8" - 2 1/8"

### 1000 SERIES

#### MECHANICAL PUSHBUTTON CYLINDRICAL KNOB LOCK

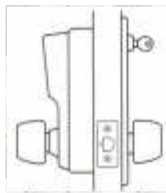

**Model 1011**  
• Combination Entry

No Key  
KA1011-05-41  
KA1011-26D-41

**Features:**

- Lock Body 7 1/8" H, 3" W, 3-13/16" D
- Latch Front 1 1/8" x 2 3/4", Backset 2 3/4"
- Door Thickness 1 3/8" to 2 1/4"
- Handing Reversible
- Core not included

**Finishes:**

- US26D Satin Chrome
- (05) for Antique Brass Finish



IL1054UN KEY BLANK

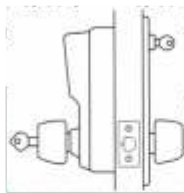

**Model 1021 — IC Prep**

- Combination Entry
- Key Override

KA1021B-26D-41 Best  
 KA1021C-26D-41 Corbin Russwin  
 KA1021S-26D-41 Schlage  
 KA1021M-26D-41 Med/Yale

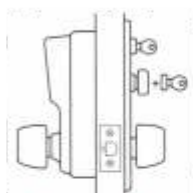

**Model 1031**

- Combination Entry
- Passage

No Key  
KA1031-26D-41

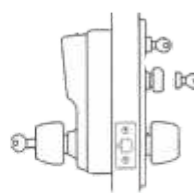

**Model 1041 — SFIC Prep**

- Combination Entry
- Key Override
- Passage

KA1041B-26D-41 Best  
 KA1041S-26D-41 Schlage

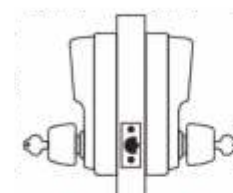

**Model EE1021S/EE1021S**

- Combination Entry
- Key Override

KAEE1021S/EE1021S26D4  
 (Double Sided)

## L1000 SERIES

### HEAVY-DUTY MECHANICAL PUSHBUTTON LEVER LOCK

**Features:**

- Mechanical, pushbutton combination
- Handicapped accessible locksets in compliance with all A.D.A. and fire codes
- Core not included

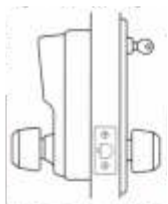
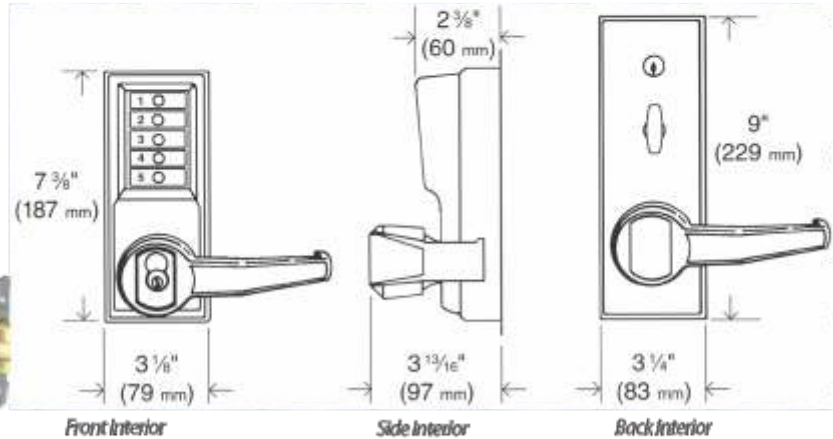

**Model L1011**  
• Combination Entry

*Model L1011 — No Key*

KALL1011-26D-41  
KALL1011-05-41  
KALR1011-26D-41  
KALR1011-05-41

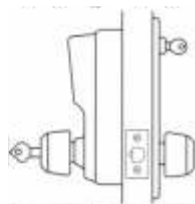

**Model L1021**  
• Combination Entry  
• Key Override

*Model L1021 — LFIC Prep*

<i>Medeco</i>	<i>Schlage</i>
KALL1021M-26D-41	KA LL1021S-05-41
KALR1021M-05-41	KA LL1021S-26D-41
KALR1021M-26D-41	KA LR1021S-05-41
	KA LR1021S-26D-41
<i>Sargent</i>	<i>Best — SFIC Prep</i>
KALL1021R-26D-41	KA LL1021B-26D-41
KALR1021R-26D-41	KA LR1021B-26D-41
<i>Corbin Russwin</i>	
KALL1021C-26D-41	
KALR1021C-26D-41	

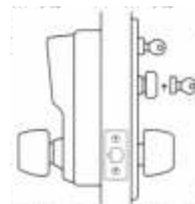

**Model L1031**  
• Combination Entry  
• Passage

*Model L1031 — No Key*

KALL1031-26D-41  
KALR1031-26D-41

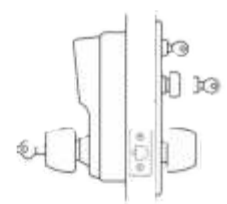

**Model L1041**  
• Combination Entry  
• Key Override  
• Passage

*Model L1041 — SFIC Prep*

KALL1041B-26D-41	Best
KALL1041S-26D-41	Schlage
KALR1041B-26D-41	Schlage
KALR1041S-26D-41	Schlage

**YOU MUST SPECIFY THE HANDING OF YOUR DOOR:**

- LL - Left Hand or Left Hand Reverse  
LR - Right Hand or Right Hand Reverse

*Finishes: • US26D Satin Chrome • (05) for Antique Brass Finish*

### LP1000 SERIES

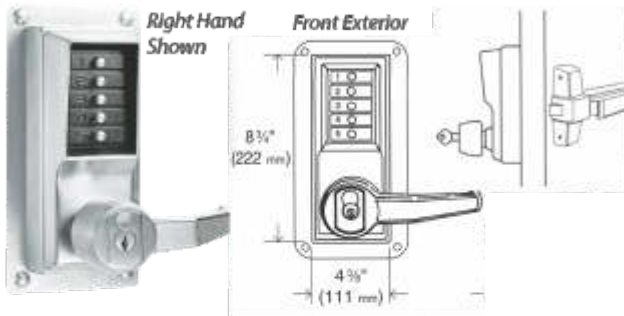

Device/Core Not Included

#### LP1000 Series Exit Device Operator

**Features:**

- Operates surface mounted (rim-mounted) exit devices
- 1 3/8" to 2 3/4"; optional 4" Door thickness

**Exit Device Compatibility:**

- Von Duprin Exit Only (EO) or Exit Only Fire (EOF) 22, 88 NL, 98, 99, 9857, 9957
- Dorma 9100, 9300, 9400
- Detex Advantex Series 10, 20, 21, 40, 50, 51
- Monarch XX-R, FXX-R, 18-R, F-18-R, XX-V, F-XX-V, 18-V, F-18-V (Requires special k-hub adapter)
- Cannot be used with mortise design or most vertical rod Exit Devices

KALLP1020B-26D-41	Best
KALLP1020S-26D-41	Schlage
KALRP1020B-26D-41	Best
KALRP1020S-26D-41	Schlage

**YOU MUST SPECIFY THE HANDING OF YOUR DOOR:**

- LL- Left Hand or Left Hand Reverse
- LR- Right Hand or Right Hand Reverse

### 2015 SERIES

#### 2015 Series Exit Device Operator

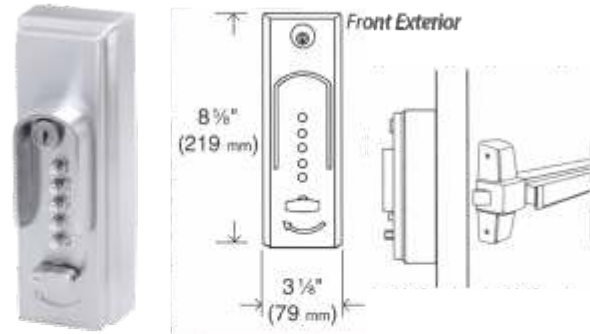

**Features:**

- For non-handed or clockwise-rotating (adjustable up to 90°) Exit Device hubs only
  - 1 3/8" to 2 3/4" Door thickness; optional 4"
  - Control: 6-pin tumbler cylinder keys for combination change access; keyed differently (IL L1003A KEY BLANK)
- Exit Device Compatibility:**
- Von Duprin 22 Rim, 22 Rim-F, 88 Rim, 88 Rim-F, 98 Rim, 98 Rim-F, 99 Rim, 99 Rim-F; 2227, 2227-F, 9827, 9827-F, 9847, 9847-F, 9927-F, 9947-F
  - Yale 1500 Series, 7000 Series
  - Uscon 2136, PB3602
  - And many others

KA2015-26D-41 Exit Device Operator

### 3000 SERIES

#### Narrow Stile Mechanical Pushbutton for Adams Rite

**Features:**

- For use with Adams Rite 4510 latch mechanisms
- Drive assembly key cylinders, cylinder trim rings, mortise latches, and egress hardware are not provided
- Key override by mortise cylinder with Adams Rite Cam
- Passage and Lockout function
- 1 7/8" minimum stile width
- Includes DF59 key and screwdriver for combination change
- H 9 3/8", W 1 1/2", D 2 3/8"
- Must order drive assembly separately

KA3001-26D-41	Narrow Stile Housing
KA3001-55-41	Narrow Stile Housing
KA3002-26D-41	w/Cylinder Guard
KA3002-55-41	w/Cylinder Guard





## 5000 SERIES

### Extra Heavy-Duty Mechanical Pushbutton Lever Lock

**Features:**

- Non-handed: Fits left and right hand doors; changes in seconds.
- ANSI/BHMA A156.2, Grade 1 Certified
- 2 3/8" Backset
- 1 3/8" to 2 3/4" Door thickness. Preassembled to accommodate doors 1 5/8" to 2"
- Key override
- Combination change from exterior

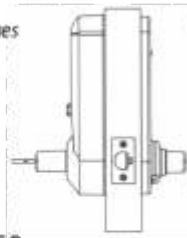

- |                   |  |
|-------------------|--|
| KA5021BWL-26D-41  | Entrance Lock • Best I/C Prep                      |
| KA5021XKWL-26D-41 | Entrance Lock • KABA Cylinder Included             |
| KA5021XSWL-26D-41 | Entrance Lock • Schlage Cylinder Included          |
| KA5041XSWL-26D-41 | Entrance/Passage Lock<br>Schlage Cylinder Included |
| KA5010XSWL-26D-41 | Exit Trim - Cyl Included                           |



Right Hand Shown

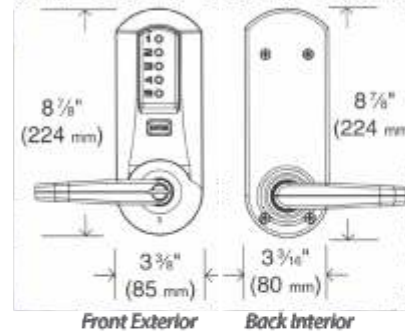

## 6200 SERIES

### Mechanical Cylindrical Thumbturn Latch

Front Exterior

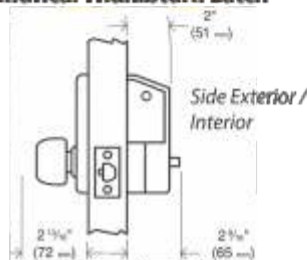

**Features:**

- Relocks each time the door closes
- Field reversible handing
- 2 3/8" or 2 3/8" Backset
- 1 3/8" to 2 1/4" Door thickness, wood or metal
- Combination change tool included

- |              |                         |
|--------------|-------------------------|
| KA6204-60-41 | 2 3/8" UL Beveled Latch |
| KA6204-86-41 | 2 3/8" UL Beveled Latch |

- Finishes:**
- 60 Gold Tone
  - 86 Gray Powder Paint

## 7100 SERIES

### Light Commercial / Residential Mechanical Pushbutton Locks

**Features:**

- Deadbolt models are manually relocking
- Deadlocking latch model automatically relocks
- Field reversible handing



**Finishes:**

- 03 Bright Brass
- 05 Antique Brass
- 26D Satin Chrome

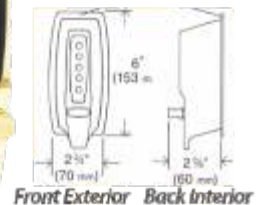

**Deadbolt**

- |               |            |
|---------------|------------|
| KA7102-03-41  | 2 3/8" PVD |
| KA7102-26D-41 | 2 3/8"     |
| KA7108-03-41  | 2 3/8"     |
| KA7108-05-41  | 2 3/8"     |
| KA7108-26D-41 | 2 3/8"     |
| KA7102-05-41  | 2 3/8"     |
| KA7102-GV-41  |            |

Models 7102, 7104, 7108

**Latch**

- |               |                  |
|---------------|------------------|
| KA7104-03-41  | 2 3/8" or 2 3/4" |
| KA7104-05-41  | 2 3/8" or 2 3/4" |
| KA7104-26D-41 | 2 3/8" or 2 3/4" |



## 9600 SERIES

### Cabinet Locks

**Features:**

- Horizontal or vertical. Two-step mortise installation using router or 5 1/2" x 1" slot with trim plate (for wood applications). Punched slot or series of 7/16" drilled holes (for metal applications)
- Bolt: End-throw/ cross-throw deadbolt (with manual relock); end-throw spring latch (with automatic relock)
- Wood doors: 3/8" to 7/8" Door thickness, sheet metal applications: 20 to 14 gauge

- |                  |                                 |
|------------------|---------------------------------|
| KA9621C20-26D-41 | Wood Application                |
| KA9622C21-26D-41 | Wood Application                |
| KA9661C10-26D-41 | Sheet Metal                     |
| KA24036-000-01   | ET □ Cam Kit<br>(Wood Dbolt ET) |



**Key Override**

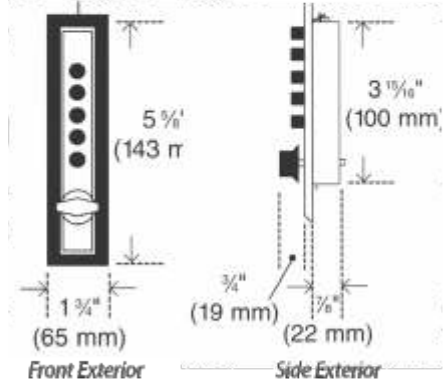

### E-PLEX 3000 SERIES



Latch Type

Right Hand Shown

**Features:**

- Electronic pushbutton lock for narrow stile aluminum glass doors
- Works with Adams Rite locks 1850 1950, 4070, 4510, 4520, 4530, 4710, 4720, 4730, 4900, 4920AN, MS 1850S and MS 1950S Series (Not Included)
- 300 access codes
- 9,000-event audit trail
- Programmed at the lock keypad or with optional
- Microsoft Excel based software
- Battery pack is located in the tamper proof base of the housing
- 3-year warranty

KAE3065MSNL-626-41	Latch Type Satin Chrome
KAE3065MSNL-744-41	Latch Type Dark Bronze
KAE3066MSNT-626-41	Bolt Type Satin Chrome
KA75429-000-01	Narrow Stile Antenna Kit

### E-PLEX 1500 SERIES



**Features:**

- Mechanical 1" throw deadbolt
- Multiple Users—100 Codes
- Adjustable Backset 2 3/4" or 2 1/4"

KAE1502-626-41 E1500 Deadbolt

### E-PLEX 2000 SERIES



Right Hand Shown

**Features:**

- No wiring to or through the door
- Field reversible
- Weather-resistant external housing, includes installation gasket
- Users and locks are easily managed at the door with simple keypad programming
- Passage mode can be pre-programmed to re-lock after a certain number of hours
- Four authority levels
- Power Plex Locks
- Self powered electronic locks do not require batteries
- Generates its own power with every turn of the lever

**E-Plex**

KAE2031XSLL-626-41	E-Plex 2000 Cylindrical Lock with Key Override
KAE2031BLL-626-41	Pushbutton Electronic lock with Best IC Key Override
KAE2031LL-626-41	No Key Override
KAP201UXSLL-626-41	Power Plex Exdt Trim

**Power Plex**

KAP2031BLL-626-41	CYLINDRICAL BEST PREP LESS CORE
KAP2031XSLL-626-41	CYLINDRICAL LEVER X SCHLAGE K.O.
KAP2031LL-626-41	NO KEY OVERRIDE

### KABA PEAKS

KA8400-25-1099-17G	KABA PEAKS PREFERRED KIK
KA8840-25-1006G	KABA PEAKS PREFERRED SPIC

## E-PLEX 5000 SERIES

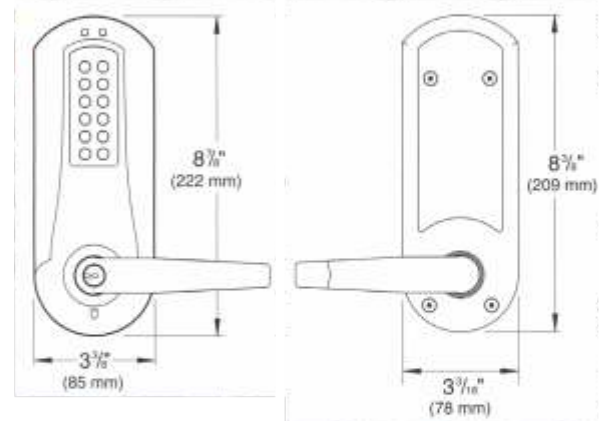

### Features:

- Non-handed, pre-assembled for left-hand door
- Latches: 1/2" throw latch, floating face plate 3/4" throw latch, beveled face plate
- Backset: 2 3/4" backset
- Minimum stile requirement: 5"
- Door Thickness: 1 3/8" to 2 1/4". Pre-assembled to accommodate doors 1 5/8" to 2". (Kits included for thin & thick doors)
- Fire Rating: Three-hour UL /ULC Fire Door Rating
- Durability: ANSI/BHMA Grade 1 Compliant
- Combines the strength, simplicity and reliability of Simplex mechanical pushbutton locks with the added security and features of electronic access control
- 100 Access Codes
- Can be programmed at the lock or managed with optional easy to use point and click Microsoft Excel™ based software
- Extensive audit trail
- 3,000 event
- Passage (Programmable) & Lockout modes
- Adjustable anti-tamper lockout disables lock after 3-9 invalid entry attempts for up to 90 seconds
- Adjustable relock time after combination entry
- Access codes from 4 to 8 digits.
- Five authority levels

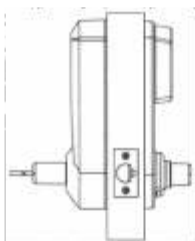

### Finishes:

Housing: Satin Chrome 26D (626)  
Lever: Satin Chrome 26D (626)

KAES010XSWL-626-41	E-Plex Exit Trim • Schlage Key-in-Lever Cylinder Included
KAES031BWL-626-41	E-Plex Cylindrical Lock • Best Type I/C Prep (less cylinder)
KAES031XKWL-626-41	E-Plex Cylindrical Lock • KABA Key-in-lever Cylinder Included
KAES031XSWL-626-41	E-Plex Cylindrical Lock • Schlage Key-in-lever Cylinder Included
KAES051BWL-626-41	E-Plex Cylindrical Lock • Best Type I/C Prep (less cylinder)
KAES067XSWL-626-41	E-Plex Mortise Lock
KAES066BWL-626-41	E-Plex Mortise Lock - No Deadbolt
KAES210XSWL-626-41	E-Plex Exit Trim
KAES231XSWL-626-41	E-Plex Cylindrical Lock
KAES631XSWL-626-41	E-Plex Cylindrical Lock
KAES710XSWL-626-41	E-Plex Exit Trim



KAE79N2031LL-B-F00626	E-Plex Prox CYL SFIC Less Core
KAE79N2031LL-K-F00626	E-Plex Prox CYL KIK



**PARTS**

**1000 & L1000 Series**

KA201009-000-01 Assembly Clutch Cover  
 KA201040-000-01 Stop Plate Assembly Kit  
 KA201050-000-01 Assembly Shaft - Standard  
 KA201304-000-01 Plate Clutch Backing  
 KA201422-000-02 Key-Passage Set DF-5  
 KA201430-000-01 Clutch Sub-Assembly  
 KA201499-000-01 Drive Sleeve Asy No Key w/ Retainer Clip  
 KA201547-000-01 Shaft Assembly - Key Override  
 KA201558-26D-01 Schlage Knob Conversion  
 KA201558-26D-01 Schlage Knob Conversion  
 KA201807-26D-01 Assembly Plug w/Tum Knob  
 KA201440-000-10 Retainer Ring 3/8" 10-Pack  
 KA201740-000-10 Passage Spring Kit 10-Pack  
 KA201745-26D Plate Trim/Uni"ed 3-Hole  
 KA201782-000-01 Inside Sleeve Kit w/Clip  
 KA203035-000-01 Service Kit 1000 Series Knobs  
 KA201770-26D-01 Outside Lever RH Standard  
 KA201771-26D-01 Outside Lever RH Standard  
 KA201772-000-01 Drive Sleeve Asy O/S NIKO  
 KA201780-000-01 Clutch Cover Asy RH  
 KA201781-000-01 Clutch Cover Asy LH  
 KA201788-000-01 Clutch Asy RH  
 KA201789-000-01 Clutch Asy LH  
 KA201792-000-01 Clutch Asy - Outside DR/Sleeve

KA201812-000-01 Asy Drive Shaft Std.  
 KA201813-000-01 Asy Drive Shaft w/Key Override  
 KA201818-26D-01 Plug Assembly w/ 2 Keys  
 KA201825-000-01 Chamber Release Kit  
 KA201840-000-01 Drive Sleeve Kit Schlage  
 KA201730-000-01 Spring/Coil Return for RH Inside Lever  
 KA201732-000-01 Spring/Coil Return for LH Inside Lever  
 KA201727-000-01 Fixed Sleeve Kit RH  
 KA201733-000-01 Fixed Sleeve Kit LH  
 KA201773-000-01 Stop Plate Kit RH  
 KA201774-000-01 Stop Plate Kit LH  
 KA201787-26D-01 Plug Assy 1000, L1000 F/Combo  
 KA203037-000-01 Service Kit L1000 RH  
 KA203038-000-01 Service Kit L1000 LH  
 KA203039-000-01 Service Kit LP1000 RH  
 KA203040-000-01 Service Kit LP1000 LH  
 KA34264-26D-01 Knob Assy No Key Override  
 KA204168-26D-01 Latch 1/2" 2 3/4" BS 3 HR  
 KA204169-26D-01 Ring Thread/Rose Bushing  
 KA204202-26D-01 Cylindrical Drive Unit  
 KA204210-26D-01 Small Parts Kit  
 KA54843-000-01 Anti-Spy Shield for 1000/L1000  
 KA74529-000-01 Drive Shaft ASSY-LP1000

Asy Drive Shaft Std.  
 Asy Drive Shaft w/Key Override  
 Plug Assembly w/ 2 Keys  
 Chamber Release Kit  
 Drive Sleeve Kit Schlage  
 Spring/Coil Return for RH Inside Lever  
 Spring/Coil Return for LH Inside Lever  
 Fixed Sleeve Kit RH  
 Fixed Sleeve Kit LH  
 Stop Plate Kit RH  
 Stop Plate Kit LH  
 Plug Assy 1000, L1000 F/Combo  
 Service Kit L1000 RH  
 Service Kit L1000 LH  
 Service Kit LP1000 RH  
 Service Kit LP1000 LH  
 Knob Assy No Key Override  
 Latch 1/2" 2 3/4" BS 3 HR  
 Ring Thread/Rose Bushing  
 Cylindrical Drive Unit  
 Small Parts Kit  
 Anti-Spy Shield for 1000/L1000  
 Drive Shaft ASSY-LP1000  
**Combination Chamber**  
 Fits 1000 / L1000 / 3000 Series  
 KA74366-000-01



**3000 Series**

**Extension Spring**

For slide stile plate assembly



KA54237-000-10 Extension Spring

**Knob Assembly**

Black

KA74349-19-01 Knob Assembly



**Complete Mounting Plate Assembly**

KA3010-19-41 3/32" BS RHR  
 KA3020-19-41 3/32" BS LHR  
 KA3030-19-41 1 1/8" BS RHR  
 KA3040-19-41 1 1/8" BS LHR  
 KA64755-000-01 Clutch ASY Complete 3000



**5000 Series**

Combination Chamber  
 Retainer Ring 3/8" 10-Pack  
 Passage Spring Clip 10-Pack  
 Lever Return Spring  
 Enter Button Kit For 5000

KA74832-000-01  
 KA201440-000-10  
 KA201740-000-10  
 KA54482.000-10  
 KA64858-26D-01

**6200 Series**

Inside Slv Kit w/ Clip  
 Combination Chamber 6200

KA201782-000-01  
 KA74870-000-01

**7000 Series**

Deadbolt Asy for 7102- 234" BS Bright Brass  
 Deadbolt Asy for 7102- 234" BS Satin Chrome  
 Deadbolt Asy for 7108- 238" BS Bright Brass  
 Deadbolt Asy for 7108- 238" BS Satin Chrome  
 Slip Clutch Kit for all 7000 models  
 Deadlatch 1/2" ADJBS for 7104  
 Deadlatch 1/2" ADJBS for 7104  
 Tailpiece Kit 7100 Series  
 Combination Chamber

KA202052-03-01  
 KA202052-26D-01  
 KA202064-03-01  
 KA202064-26D-01  
 KA202081-090-01  
 KA54444-03-01  
 KA54444-26D-01  
 KA64769-000-01  
 KA74660-000-01

**8100 Series**

Retainer Ring 3/8"  
 Passage Spring Clip  
 Fixed Slv Kit RH  
 Fixed Slv Kit LH

KA201440-000-10  
 KA201740-000-10  
 KA201727-000-01  
 KA201733-000-01

**PARTS — continued**

<p><b>E-Plex Series</b></p> <p>KAEP-MU-COM-001 M-Unit Kit for Laptop or Netbook PC's          KA54644-000-41 Weather Cover          KA74892-000-01 Tailpiece Kit E5000 KII          KA75262-000-01 Swing-Bolt Cam Assembly          KA0001-10-8087 Signature Card          KA065-501367CC Cleaning Cards          KA600048-000-01 Cylinder Adapter Disc Kit          KA012-509971-EP E2031 Lever Spring (O/S)          KA062-513717 Service Kit E2000 KII/Best IC          KAE79N2013LL-B-F00626 E-Plex Prox Cyl SFIC Less Core          KAE79N2013LL-K-F00626 E-Plex Prox Cyl KIK Cylinder          KA118-515912PRX E7900 Prox Program Card Kit</p>	<p><b>Miscellaneous</b></p> <p>KA201144-26D-01 Latch 3/4" Antifriction          KA201278-000-01 Wrench &amp; DF-59 w/2 Keys          KA74080-000-01 Combination Chamber 900          KA742412-000-01 Comb Chamber Kit Simplex 2015          KA74303-000-01 Tailpiece/Ring ASY          KA120-PROXKEYIII HID PROX KEY III #1346</p>
<p><b>Identity Access Management Kit</b>  <i>Fingerprint Biometric/Pin</i></p> <p>KAAD102KIT</p>	<p><b>2 3/8" Backset Latch</b>          For Simplex 1000, L1000, 5000, 6200 &amp; E-Plex 2000, 5000 Series</p> <p>KA75185-26D-01</p>

## AUDITCON 2 SERIES



### Auditcon® 2 Series - Model 52

The only true stand-alone electronic safe lock designed to retrofit mechanical locks for residential and commercial applications, featuring PowerStar™ or PowerSaver™ technology. This single user design with dual user access capability features a 6-digit user combination and wrong try lockout (5 attempts) for three minutes.



### Auditcon® 2 Series - Model 252 & 552

This U.L. Type 1 rated safe lock easily replaces traditional mechanical Group I and Group II locks. The Auditcon Model 252 is perfect for security applications where shared access and audit capability are necessary.

AUDITCON® 2 SERIES Model Comparisons			
OPTIONS	52/T52	252	552
Keypad Housing Styles	Round/Vertical	Round/Vertical	Round/Vertical
Bolt Styles	Dead Bolt or Slide Bolt	Dead Bolt or Slide Bolt	Dead Bolt or Slide Bolt
Users	2 Users	20 Users	99 Users
Combination Length	6 digit	8 digit	8 digit
Power Source	Self-Powered	Self-Powered	Self-Powered
Battery Assist	-	Optional	Optional
Manager/Master Control	Yes (Manager)	Yes (Master)	Yes (Master)
Supervisor/Subordinate Mode	No	Yes	Yes
Single/Dual Custody Access	Yes	Yes	Yes
Wrong Try Lockout	Yes	Yes	Yes
Time Delay / Open Window	-	1-99 min delay 1-20 min opening	1-99 min delay 1-20 min opening
Time Delay Override	-	Yes	Yes
Time Delay Display	-	Optional	Optional
Time and Date	No	No	Yes
Timed Lockout	No	No	Yes (1-255 hrs)
Time Windows	No	No	Yes
Time Window Lockout	No	No	Yes
Uploadable Programming <input type="checkbox"/>	No	Yes	Yes
Downloadable Audit Trail <input type="checkbox"/>	No	100 audits	400 audits

Requires optionally purchased Auditcon 2 Series software package.

#### Model 52/T52

KM052SVN10N5BEA1A 52 Vertical

#### Model 252

KM252SRN20N5BEA1A 252 Round

KM252SVN20N5BEA1A 252 Vertical

KM252AVN20N5BEA1A 252 Vertical

#### Accessories

KM202020 Key F (Blue)

KM202021 Key SA (Red)

KM202021 SA Key (Audit Transfer)

KM301101 Auditcon 2 Implementation

#### Model 552

KM552ARN20N5BEA1A 552 ARN Dead Bolt

KM552AVN20N5BEA1A 552AVN Dead Bolt



## X-10

### X-10™ High Security Lock



#### The X-10 is Impervious to External Attack

*Kaba Mas is proud to announce the newly designed X-10 - the secure tradition continues. With nearly one million sold, the Kaba Mas X-0 series is the choice for securing the Government's most sensitive material. The X-10 was designed and developed as a direct result of the latest revision to federal specification FF-L-2740 (now Revision "B").*

*This is the US Government's highest security standard for container locks and doors. The X-10 is the approved lock for "Style 1" applications.*

*The X-10 is approved by the GSA for use on approved Class 5 and Class 6 Filing Cabinets and Class 5 Security Vault Doors. The X-10 is self-powered using "green" PowerStar™ technology. Simply rotate the dial to power up the lock and enter the combination. Intuitive, visual controls guide the operator through programming and audit features. The X-10 provides all the benefits of high-security electronic locking while maintaining the reliability of a mechanical lock, independent of batteries or outside power sources.*

#### New - Backlit Display

*A unique, standard feature of each X-10 manufactured after March 25th, 2014 is the new backlit LCD. With a simple turn of the dial, the screen illuminates, eliminating the need for external light sources when locks are installed in poorly lit storage areas. The backlit display X-10 is GSA approved and utilizes all of the existing part numbers.*

*The X-10 offers three modes of operation, and features Automatic Lock Reset, High-Security combination scramble. The X-10 resists all forms of external manipulation and environmental attack.*



#### X-10 PARTS

KM114004 CDX Strike Type 2  
 KM114005 CDX Strike Type 3

## DOOR PRODUCTS

### K-24 Hardened Cylinder Guard Ring



Spins Free Both Ways

- Features:**
- Each six pack contains: 6 hardened steel rings, 6 Stainless steel wave washers & 6 spacing collars
  - Hardened Steel
  - Free Spinning
  - Tapered and Cone Shaped

KEK-24A Aluminum Powder Coat  
KEK-24B Duranodic Powder Coat

### K-24L Extra Large Hardened Cylinder Guard Ring



Spins Free Both Ways

- Features:**
- Accommodates 1-1/4" - 1-3/8" High security & interchangeable core cylinders
  - Contains 1 hardened steel ring, 1 stainless steel wave washer & 1 spacing collar
  - Hardened Steel
  - Free Spinning
  - Tapered

KEK-24LA Aluminum Powder Coat  
KEK-24LB Duranodic Powder Coat

### Armored Door Loops

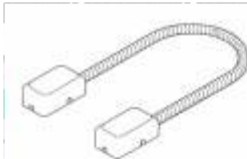

- Features:**
- Available with a 18" or 24" Flexible Armored Conduit
  - Durable powder coat finish
  - Pre-drilled hole in base

- KEK-DLA 1/4" ID Flex (18") Aluminum  
KEK-DLA24 1/4" ID Flex (24") Aluminum  
KEK-DLB 1/4" ID Flex (18") Duranodic  
KEK-DLB24 1/4" ID Flex (24") Duranodic  
KEK-DL38A 3/8" ID Flex (18") Aluminum  
KEK-DL38B 3/8" ID Flex (18") Duranodic  
KEK-DS 1/4" SS Flex (18") Stainless Steel

## WELDABLE GATE BOXES

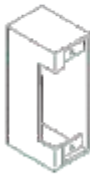

- Features:**
- Use with Adams Rite 7100, 7101 & 7140. HES 5000U (501-Option) Trimec ES100. Refu 2402
  - 5 1/2" H x 2 3/8" L x 1 3/8" W
  - 14 Gauge Steel

KEK-BXES3A

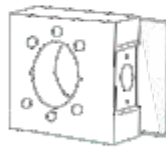

- Features:**
- Universal hole pattern allows use with many lever sets
  - 2 3/4" Backset
  - 4 1/8" H x 4 3/8" L x 1 3/8" W
  - 14 Gauge Steel

KEK-BXRHO

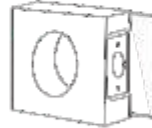

- Features:**
- Single Lock Box
  - 2 3/4" Backset
  - 2 1/8" Hole Size
  - 3 1/2" H x 4 3/8" L x 1 1/8" W
  - 14 Gauge Steel

KEK-BXSG234



Weldable Bracket

KEK-BXSTR

## TOOLS & MISCELLANEOUS

### Change Key Set

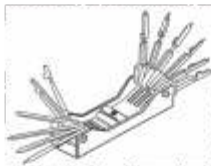

- Features:**
- 12 most common change keys
  - Case is engraved with description of uses

KEK-18

### K-18 Includes:

- Mosler-35-4 Wheel  
S&G Amsec 3 Wheel (K-18-3); S&G-6720-3 Wheel (K-18-4); Diebold-180-3 Wheel (K-18-5); Diebold-177-4 Wheel (K-18-6); S&G Padlock-3-Wheel (K-18-7); S&G-4163 (K-18-8); La Gard-1R-3 Wheel (K-18-9); La Gard 3 Wheel (K-18-10); La Gard 4 Wheel (K-18-11); La Gard-Amsec-3 Wheel (K-18-12)

### Spin Out Screwdriver (for Mortise Cylinders)

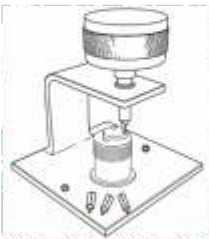

- Features:**
- Four sizes of interchangeable screwdriver bits - two slotted and two Phillips

KESPIN

### Door Laser



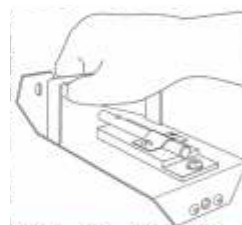







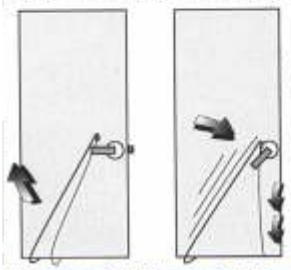

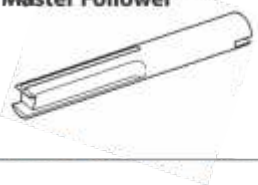
(K-18-1); Mosler-302-3 Wheel (K-18-2);



- Features:**
- Core drilling doors
  - Includes 1/4" Bit For Drilling Pilot Hole





KEDLSR

## TOOLS & MISCELLANEOUS





<p><b>Lever Opening Tool</b></p>  <p><i>If you can slide this tool under the door, you will open it!</i></p> <p>KEK-22      Lever Opening Tool KEK-22CABLE      Replacement Cable</p>	<p><b>Camera Wafer Reader</b></p>  <p>KEUSB-WR</p>
<p><b>Master Follower</b></p>  <p>Solid brass KEK-6</p>	<p><b>Twist Key Assist</b></p>  <p>Features: • Ability to keep up to 3 keys in order, easily accessible</p> <p>KEKEE EZ</p>
<p><b>Hose Bibb Lock</b></p>  <p>KEK-HBL</p>	<p><b>Transfer Dial</b></p>  <p>Features: • Allows dialing of a safe away from the drill point • Easy transfer of gate to any position fast and accurately • Precise one to one ratio between dial and spindle • Easy to read large format dial. Attaches strongly with rare earth magnets</p> <p>KEK-ETD</p>
<p><b>Wire Running Rods Kit</b></p>  <p>KEW-RR33</p>	<p><b>Flex Bits</b></p>  <p>KEFB-38X24 3/8"x24" KEFB-38X48 3/8"x48"</p>
<p><b>Cam Lock Stop Bracket</b></p> <p>KEBRCAM</p> 	<p><b>EZ Load</b></p> <p>KEEZ LOAD Reloading Tool</p> 
<p><b>Smart Phone Viewer</b></p> <p>KEK-SPV</p> 	



## NETWORKABLE ACCESS CONTROL

 <p><b>KRPXL-500P</b></p> <p><b>PXL-500 Tiger Controller II</b>  <i>Features:</i></p> <ul style="list-style-type: none"> <li>• Manage a single door, alarm output, and 2 reader ports</li> <li>• Locking Metal Enclosure that can also house KPS-4 • Power Supply and battery</li> <li>• Added RAM for increased cardholder capacity (up to 65K per controller)</li> <li>• Alarm integration capability with GE Interlogix/Caddx NX-8E Alarm Panel</li> <li>• On-board LAN socket for new low cost LAN-500</li> </ul> <p><i>Increased EEPROM memory to support future enhanced firmware capabilities</i></p>	<p><b>SB-593 Satellite Board</b>  <i>Features:</i></p> <ul style="list-style-type: none"> <li>• The Expansion Board plugs directly onto the PXL-500 to provide an additional 8 general purpose inputs and 4 general purpose outputs</li> <li>• With a simple jumper setting, two of the inputs and two of the outputs are configured to economically manage a second door</li> </ul> <p><b>KRSB-593</b></p>
 <p><b>KRNXT-2D</b>  <b>KRNXT-2D-MS</b></p> <p><b>Two Door/Four Reader Controller</b>  <i>Manages 2 doors access and egress (4 readers) when used with NXT Proximity Readers, or 2 doors (2 doors access or 1 door access + egress) when used with MS or Wiegand reader types, with enclosure. Allows unshielded CAT5 cable. Utilizes existing LAN/WAN/Ethernet or pull your own dedicated CAT-5 Network.</i></p> <p><i>• Mercury Powered Option (-MSC) provides additional features and allows In/Out NXT readers on the same reader port</i></p>	 <p><b>KRNXT-4D</b>  <b>KRNXT-4D-MS</b></p> <p><b>Four Door/Eight Reader Controller</b>  <i>Embedded MAC Address for one-button Auto Configuration, standard 4 PIN Block and RJ Jack built-in for network connection. Up to 64 Controllers (256 doors) and 1024 auxiliary I/O points per controller network 50,000 Cardholders, 10,000 Selectable Event Butler per controller.</i></p> <p><i>• Mercury Powered Option (-MSC) provides additional features and allows In/Out NXT readers on the same reader port</i></p>
 <p><b>KRLAN-520AESP</b></p> <p><b>LAN-520 Port</b>  <i>Keri's LAN-520 LAN Port in combination with an NC-485X Network Converter and PXL-500 Tiger II Controllers (normally connected via a two-wire RS-485 network) can be connected via Ethernet to bridge long distances within a facility or campus, as well as across any distance where a LAN/WAN exists, combine what would normally be separate sites, each with their own RS-485 network, into a single site for better security management, whether across a corporate campus or across town.</i></p>	 <p><b>KRIP-2003X</b> Proximity Reader Mullion  <b>KRIP-2005BX</b> Proximity Reader Gangplate  <b>KRHPP-22</b> Programmer Hand Held</p> <p><b>IntelliProx™ 2000</b>  <i>Features:</i></p> <ul style="list-style-type: none"> <li>• Manage access to a single door for up to 500 users</li> <li>• 26 bit Wiegand output for later expansion to a larger system</li> </ul>

## PROX READERS

 <p><b>KRP-300H</b></p> <p><b>Cascade Proximity Reader</b>  <i>Features:</i></p> <ul style="list-style-type: none"> <li>• May be mounted directly to a metal door or window frame (mullion)</li> <li>• Read both HID and Pyramid Series cards and tags</li> </ul>	<p><b>KRNXT-3R</b> Door Frame Reader  <b>KRNXT-5R</b> Wall Switch Reader</p>  <p><b>KRNXT-5R</b></p>  <p><b>KRNXT-3R</b></p>
 <p><b>KRP-500H</b></p> <p><b>Pyramid Series Proximity Reader</b></p>	

## PROX READERS — continued

<p><b>MS-3000 MicroStar Proximity Reader</b>  <i>Features:</i>  <ul style="list-style-type: none"> <li>• Mount directly on a metal window/door frame (mullion)</li> <li>• Lifetime warranty</li> </ul> <b>KRMS-3000X</b></p>	<p><b>MS-5000 MiniStar Proximity Reader</b>  <i>Features:</i>  <ul style="list-style-type: none"> <li>• Mount on a standard USA single gang box, MiniStar provides up to 7" (18 cm) read range</li> </ul> <b>KRMS-5000BX</b></p>
--	--

## CREDENTIALS

<p><b>Proximity Key Tags</b>          KRPKT-10X          KRPKT-26X          KRPSK-3          IntelliProx          Pyramid</p>	<p><b>Standard Light Proximity Card</b>  <i>Features:</i>  <ul style="list-style-type: none"> <li>• Lifetime warranty</li> <li>• Vertical slot punch</li> </ul>         KRKC-10X          KRKC-26X          IntelliProx</p>	<p><b>ISO Prox Card W/O Mag Strip</b></p> <p>KRNXT-I</p>
<p><b>Prox Key Tag</b>          KRNXT-K</p>	<p><b>Clamshell Proximity Card</b>          KRNXT-C</p>	

## ACCESSORIES

<p><b>Software</b></p> <p><b>KR DOORS NET</b></p>			
<p><b>KRKDP-552</b></p>	<p><b>KRIRP-1</b>  <b>KRNXT-RM3</b>  <b>KRUSB-A</b></p> <p><b>KRIRP-1</b>  <b>KRNXT-RM3</b>  <b>KRUSB-A</b></p> <p>Cable: PXL-500/IP-2000 to PC Modem (DB9 to Pigtail)          Isolation Kit 12/24 VDC          Reader Interface Module          Network Adapter</p>	<p><b>KRKPS-4-1</b>  <b>KRKPS-5-1</b>  <b>KRKPS-8</b></p>	<p><b>12VDC 2amp Power Supply</b>  <b>Mounts in PXL-500 Box</b>  <b>12VDC 2amp Power Supply</b>  <b>Battery Ready w/Enclosure</b>  <b>Battery 12VDC 7.2AH 20Hr</b></p>

## AURORA



- VMS integration
- Active Directory integration
- Aurora web client interface
- E-Plex wireless lock integration
- Centrally managed access control
- Upgrade to full SQL server
- Optional licensed and add-on modules for enhanced and added functionality
- People-centric methodology
- Unlimited user-definable fields
- Optional licensed Software Development Kit (SDK)
- English, French, Spanish and Portuguese language support

KEYSCAN-AURORA Access Control Software

**CA150 - Single Door PoE® Control Unit**

When it comes to performance, capacity, and overall capability, the CA150 is comparable with our full line of access control units. The CA150 is designed to perform with Keyscan access control management software.

- Innovative IP "At the Edge" solution
- Network appliance-based connectivity with built-in PoE ready TCP/IP module
- PoE mode powers reader, strike, and other auxiliary devices
- DHCP supported
- Dual processors
- Flash memory
- Two reader ports

KEYSCAN-CA150 Single Door Controller

**CA250 - 2 Reader Access Control Unit**

Each CA250 includes the following components.

- 1 - CA250B ACU control board
- 1 - OCB8 relay board
- 1 - DPS-15 dual linear power supply
- 1 - Black metal enclosure

KEYSCAN-CA250 2-Reader Access Control Unit

**CA4500 - 4 Reader Access Control Unit**

Each CA4500 includes the following components.

- 1 - CA4500B ACU control board
- 1 - OCB8 relay board
- 1 - DPS-15 dual linear power supply
- 1 - Black metal enclosure

KEYSCAN-CA4500 4-Reader Access Control Unit





**CA8500 - 8 Reader Access Control Unit**

Each CA8500 includes the following components.

- 1 - CA8500B ACU control board
- 2 - OCB8 relay boards
- 1 - DPS-15 dual linear power supply
- 1 - Black metal enclosure

KEYSCAN-CA8500 8-Reader Access Control Unit



**Keyscan K-PROX3**

The Keyscan K-PROX3 is a robust and affordable reader with a sleek, modern finish. The K-PROX3 features stellar technology, multiple mounting options and anti-tamper capability for unrivalled performance and dependability.

K-PROX3 boasts dedicated features designed for exclusive use with Keyscan's Present3 and facility lockdown functions. When enabled, the reader will indicate status with new auxiliary LED indicators. These features are enabled with firmware and a programming card (sold separately).

However, basic reader functions will work on older Keyscan controls and non-Keyscan controls.

The K-PROX3 is the ideal choice for Keyscan access control systems with 125 kHz proximity reader requirements.

KEYSCAN-K-PROX3 Prox Reader & Plate 125kHz

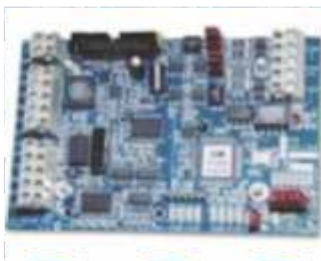

**Keyscan CIM Communication Interlink Module**

Keyscan CIM-LINK Global Network (LAN/WAN) Connectivity Module



**NETCOM2P**

Plug-On TCP/IP Communication Adaptors

Networking Keyscan access control units is made easy by using the NETCOM2P

- Allows maximum system design options
- Plugs directly onto the CIM to establish network communication
- Can also plug directly on the control board for single ACU applications
- Also available with AES Rijndael 256-bit encryption - NETCOM6P

KEYSCAN-NETCOM2P Network Communication Board



KEYSCAN-USB-SER USB Communication Adapter

**KeyScan CS125-36 Clamshell Credentials**

KeyScan's CS125 standard proximity clamshell cards are designed to be used with KeyScan proximity readers K-PROX3, K-KPR, K-VAN, Farpointe readers as well as other 125 kHz compatible readers.

- Available in KeyScan 36-bit format
- Up to a 4" read range
- An affordable alternative to other compatible card credentials
- Will function with KeyScan and other 125 kHz compatible low frequency readers

KEYSCAN-CS125-36 Clamshell Card 36-Bit 50/pack

**KeyScan PROXKEYIII Key Fobs**

KEYSCAN-PROXKEYIII HID Prox Key Fob 50/pack

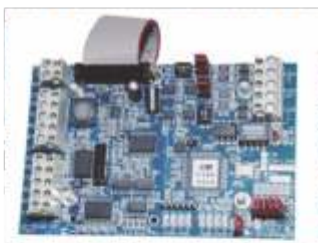

KEYSCAN-CIM Communication Interlink Module



KEYSCAN-SDAC Luna Single Door Controller

### TAMPER-PROOF KEY RINGS

- Both solid and braided versions are made of industrial strength stainless steel
- Ring comes engraved with unique set of markings for identification purposes
- Permanent ID prevents someone from removing or substituting keys without your detection



**KI270**  
 • Solid Ring 2" (5cm)  
 • Holds Approximately 30 Keys

**KI277**  
 • Solid Ring 3" (7cm)  
 • Holds Approximately 46 Keys

**KI278**  
 • Solid Ring 1.625" (4cm)  
 • Holds Approximately 22 Keys

**KI279**  
 • Solid Ring 1" (3cm)  
 • Holds Approximately 14 Keys



**KI271D**  
**Tool - Sealing**  
 Permanently seals the ring so it can not be reopened (Solid & Flex Rings).



**KI271V**  
**Tool - Closing**  
 Closes open rings so they can be sealed. (Solid Rings Only).

### VEL-KEY PRODUCTS

**KI212 - Key Tag-12 Pack**



**Key Rack by the Inch**  
 VELCRO® key tag easily holds 6 keys like magic! Tags pull off quickly from backing when you need them! Self-adhesive backing sticks to most surfaces, anywhere you keep keys.

**KI101**  
**Zipper Case- Small**



- 24 key tag positions
- Key tags are held on by Velcro
- Rings hold up to 6 keys

**KI102**  
**Zipper Case- Large**



- 48 key tag positions
- Key tags are held on by Velcro
- Rings hold up to 6 keys





Power Generation Security



Emergency Access



After-hours Deliveries



Worksites



Facilities / Hospitality / University / Office



Hospitals / Healthcare

# Kidde: The Destination for Mechanical KeySafe Solutions

Leveraging its 100 years of product design and mechanical engineering expertise, Kidde offers top quality key-control and entry-management products.

Choose Kidde keyed or coded keyboxes for no-fuss access to customer sites, remote facilities, and office buildings. Save your customers time by preventing lockouts, lost keys, rekeying locks and cumbersome key audits. Look for new ways to expand your business via Kidde's wide variety of safety and security products.



**If you use keys, you need one of these.**

Learn more! [Kidde.com](http://Kidde.com) or contact Kidde at: 1-800-880-6788



**KEY SAFE™**



**Dial Mortise Pushbutton**

**KeySafe Original (Permanent)**

- Holds up to five keys
- Mounting hardware included

- |          |                                    |
|----------|------------------------------------|
| KD000404 | BLACK DIAL (INDIVIDUAL PACK)       |
| KD000514 | BLACK DIAL (BOXED)                 |
| KD000534 | BLACK MORTISE (BOXED)              |
| KD001015 | GRAY PUSHBUTTON (BOXED)            |
| KD001360 | WHITE PUSHBUTTON (INDIVIDUAL PACK) |
| KD001365 | GRAY PUSHBUTTON (INDIVIDUAL PACK)  |



**Dial Pushbutton**

**KeySafe Original (Portable)**

- Hangs easily on doorknob, fence, railing or pipe
- No tools necessary
- Constructed of sturdy metal with protective rubber shell and is guaranteed never to rust

- |          |                                       |
|----------|---------------------------------------|
| KD000394 | BLACK DIAL (INDIVIDUAL PACK)          |
| KD000524 | BLACK DIAL (BOXED)                    |
| KD001192 | TITANIUM PUSHBUTTON (INDIVIDUAL PACK) |
| KD001166 | TITANIUM PUSHBUTTON (BOXED)           |
| KD001404 | CLAY PUSHBUTTON (BOXED)               |



**KeySafe Original (Slimline)**

- Attaches to any wall or flat surface
- Mounting hardware included
- Holds two keys

- |          |                            |
|----------|----------------------------|
| KD001193 | TITANIUM (INDIVIDUAL PACK) |
| KD001370 | WHITE (INDIVIDUAL PACK)    |
| KD001371 | CLAY (INDIVIDUAL PACK)     |
| KD001170 | TITANIUM (BOXED)           |



**KeySafe Pro**

- Over-the-door mount specific design
- Fits correctly into door frames for both fixed and temporary key holding

- |          |              |
|----------|--------------|
| KD001017 | GRAY (BOXED) |
|----------|--------------|



**KeySafe Auto (Permanent)**

- Includes a protective weather cover and 4 self-tapping screws
- Mount into wheel well, onto frame, tow hitch, trailer tongue and more
- Vehicle keys will be there when you need them
- Cover protects from road grime and debris (snow, ice, salt)

- |          |                            |
|----------|----------------------------|
| KD001312 | TITANIUM (INDIVIDUAL PACK) |
|----------|----------------------------|



**KeySafe Pro**

- Perfect for storing access cards, multiple keys and keys with large handles
- Perfect for shops and maintenance crews needing to store multiple keys, as in lockout/tagout applications

- |         |               |
|---------|---------------|
| KD00126 | BLACK (BOXED) |
|---------|---------------|



## KEY SAFE™ — continued

### KeySafe Accessories

• Lids and protective covers for the KeySafe Original series

KD001310 **BLACK PORTABLE COVER** (VISUAL PACK)  
 KD001375 **BLACK SLIMLINE COVER** (VISUAL PACK)

**Portable  
Cover**



**Slimline  
Cover**

## TOUCHPOINT LOCK™

### TouchPoint Lock™

• Designed to replace a standard cam lock  
 • Solid die cast body and a clutch mechanism to turn the cam  
 • Can be mounted on door surface or flush mounted into the door

KD001773 **TITANIUM** (VISUAL PACK - WITH BRACKET)  
 KD001798 **CLAY** (VISUAL PACK - WITH BRACKET)  
 KD001827 **TITANIUM** (VISUAL PACK - VERTICAL BRACKET)



**Clay with Bracket,  
Fits ¾" Double D**

## KEY CABINETS & STOR-A-KEY

### Key Cabinet Pro

• Include numbered key tags with key rings and lock location chart for easy reference  
 • -16 gauge steel, more depth for larger key rings & keys hang directly on hooks  
 • Clay Colored

### TouchPoint

• Instant access, clutch mechanism protects from forced entry & never re-key locks again

### Keyed Lock

• Keyed cam lock and two keys

• Keyblank = GE 001820

• Sizes: 30-Key - 11.75 x 7.875 x 2.375 in.  
 60- and 120-key - 19.25 x 13.375 x 4 in.

### TouchPoint Lock

KD001795 30-Key  
 KD001796 60-Key  
 KD001797 120-Key

### Keyed Lock

KD001801 30-Key  
 KD001802 60-Key  
 KD001803 120-Key

### Key Blank

KD001820



### Locking Stor-A-Key

• Attach Locking Stor-A-Key anywhere using magnet or adhesive metal plate (included)  
 • Anchor point for strap or cable tie

KD001844 **CHARCOAL** (VISUAL PACK)



### Portable Stor-A-Key

• Resettable combination lock and adjustable cable

KD001948 **ASSORTED**  
(VISUAL PACK)





## CORES

### INTERCHANGEABLE CORE PRODUCTS INTERCHANGEABLE WITH: BEST - ARROW - EAGLE - FALCON - LOCKWOOD

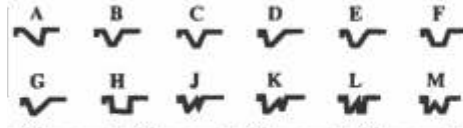

**6-Pin Cores -  
Uncombined**

- KP206-A-26D
- KP206-A-4
- KP206-B-26D
- KP206-C-26D
- v
- KP206-E-26D
- KP206-F-26D
- KP206-G-26D
- KP206-H-26D
- KP206-J-26D
- KP206-K-26D
- KP206-L-26D
- KP206-M-26D
- KP206-Q-26D

**7-Pin Cores -  
Uncombined**

- KP207-A-26D
- KP207-B-26D
- KP207-C-26D
- KP207-D-26D
- KP207-E-26D
- KP207-F-26D
- KP207-G-26D
- KP207-H-26D
- KP207-J-26D
- KP207-K-26D
- KP207-L-26D
- KP207-M-26D
- KP207-Q-26D

**6 & 7-Pin Cores -  
Combined**

- KP206C-A-26D-KA11
- KP206C-A-26D-KD
- KP206C-A-4-KA22
- KP206C-A-4-KD
- KP207C-A-26D-KA11

- W/2 Keys, 6 Pin
- W/2 Keys, 6 Pin
- W/2 Keys, 6 Pin
- W/2 Keys, 7 Pin



## HOUSINGS

**FOR 6 PIN CORES — MORTISE 1 1/4"**

- KP306-600-26D
- KP306-601-10B
- KP306-601-26D
- KP306-602-26D

- Standard
- Adams Rite
- Adams Rite
- Clover



**FOR 6 PIN CORES — RIM**

- KP308-6-26D



**FOR 6 OR 7 PIN CORES — MORTISE 1 3/8"**

- KP307-600-10B
- KP307-600-26D
- KP307-602-26D
- KP307-602-L-26D

- Standard
- Standard
- Clover
- Schlage



**FOR 6 OR 7 PIN CORES — RIM**

- KP308-10B
- KP308-26D



**FOR 6 OR 7 PIN CORES — MORTISE TAPERED HEAD**

- KP317-601-10B
- KP317-601-26D

- Adams Rite
- Adams Rite



## HOUSINGS & CAMS

### CAM RETAINER & SCREWS



KP400 Cam Retainer (Pkg Of 100)  
 KP405 Cam Screw (Pkg Of 100)

### MORTISE HOUSINGS — LESS CAM



• Each Housing Includes Cam Retainer and 2 Screws

KP406-26D 1¼" w/Cam Ret & Screws  
 KP407-10B 1¾" w/Cam Ret & Screws  
 KP407-26D 1¾" w/Cam Ret & Screws



**KP K700**  
 Standard Cam



**KP K701**  
 Adams Rite Cam



**KP K702L**  
 Schlage L Cam



**KP K702S**  
 Sargent Cam



**KP K702**  
 Clover Cam



KP400KC-A  
 KP408 RIM-MORT HOUSING KIT  
 KP408-CorbinRusswin-10B  
 KP408-CorbinRusswin-26D  
 KP408-KIT ALL KSP SFIC 10B  
 KP408-KIT ALL KSP SFIC 26D  
 KP408-KIT ALL SARGENT 10B  
 KP408-KIT ALL SARGENT 26D  
 KP408-KIT ALL SCHLAGE 10B  
 KP408-KIT ALL SCHLAGE 26D  
 KP408-KSP-10B  
 KP408-KSP-26D  
 KP408-MEDECO-10B  
 KP408-MEDECO-26D  
 KP408-SARGENT-10B  
 KP408-SCHLAGE-10B  
 KP408-SCHLAGE-26D  
 KP408-YALE-10B  
 KP408-YALE-26D  
 KPK7-CAM-KIT



Cut Control Key "FBI"  
 Convertible Housing Kit w/1-ea  
 Convertible Housing Cor-Rus  
 Convertible Housing Cor-Rus  
 Convertible Housing Kit  
 Convertible Housing Kit  
 Convertible Housing Kit  
 Convertible Housing Kit  
 Convertible Housing Kit  
 Convertible Housing KSP SFIC  
 Convertible Housing KSP SFIC  
 Convertible Housing Medeco  
 Convertible Housing Medeco  
 Convertible Housing Sargent  
 Convertible Housing Schlage  
 Convertible Housing Schlage  
 Convertible Housing Yale  
 Convertible Housing Yale  
 CamKit: KSP Screw-on Cams

## I/C TOOLS

### Ejector Punch



• Interchangeable with: Best, Arrow, and Falcon I/C  
 KP610

### Capping Block & Punch

• Interchangeable with: Best, Arrow, and Falcon I/C

KP606 Capping Block & Punch  
 KP606 PUNCH ONLY Replacement Punch



### Housing Wrench SFIC

KP609

### KEVO



kēvo

KS925-DB-15  
KS926

BLUETOOTH; SATIN NICKEL  
KEY FOB

### SIGNATURE SERIES

Grade 2



HANCOCK

**Passage**

KS720H-3-6AL-SCS  
KS720H-15-6AL-SCS  
KS720H-26D-6AL-SCS

**Entry**

KS740H-3-SCAL-SCS-K2  
KS740H-5-SCAL-SCS-K2  
KS740H-15-SCAL-SCS-K2  
KS740H-26D-SCAL-SCS-K2

**Vestibule**

KS750H-3-SCAL-SCS-K2  
KS750H-26D-SCAL-SCS-K2

**Function Description:**

720 - Hall & Closet: For all interior doors where latch is required. Plain knob both sides.

740 - Entry: Keyed exterior. Turn button on interior knobs will lock or unlock both knobs.

750 - Vestibule: Plain independent turning interior knob and always locked exterior knob.

### KNOBLOCKS

Grade 3



TYLO DESIGN

KS 300T



KS 200T

Finishes:  
US3 BRASS  
US5 ANT. BRASS

**Passage**

KS200T-3-SCAL-SCS  
KS200T-5-SCAL-SCS  
KS200T-26D-SCAL-SCS  
KS200T-15-6AL-RCS PASSAGE LOCK TYLO  
KS400T-15-6AL-RCS ENTRY LOCK TYLO

**Bed / Bath**

KS300T-3-SCAL-SCS

**Entry**

KS400T-3-SCAL-SCS-K2  
KS400T-5-SCAL-SCS-K2  
KS400T-26D-6AL-SCS-K3

### KWIKSET SERIES

Grade 3



DELTA

**405 Keyed Entry Lever**

KS405DL-3-SCAL-SCS-K2  
KS405DL-5-SCAL-SCS-K2



## SIGNATURE SERIES

Grade 2



### Single Cylinder

KS780-15-RFAL-SCS-K2  
KS780-26D-SCAL-SCS-K2  
KS780-3-SCAL-SCS-K2  
KS780-5-SCAL-SCS-K2

### Double Cylinder

KS785-26D-SCAL-SCS-K2  
KS785-3-SCAL-SCS-K2

#### Features:

- SCAL = Square Corner Adjustable Latch
- RFAL = Round Face Adjustable Latch (Drive-In)
- Maximum security one way screws standard with double cylinder function
- Supplied with extra long 3" Phillips head screws for strike

## KWIKSET SERIES

Grade 3



### The 660 Series Deadbolt

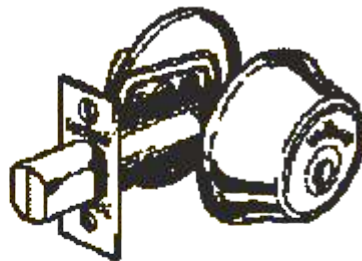

### 660 Standard Duty (SINGLE CYLINDER)

KS660-3-SCAL-SCS-K2  
KS660-3-RFAL-SCS-K2  
KS660-5-SCAL-SCS-K2  
KS660-5-RFAL-SCS-K2  
KS660-15-RCAL-SCS-K2  
KS660-15-SCAL-SCS-K2  
KS660-26D-RFAL-SCS-K2  
KS660-26D-SCAL-SCS-K2

### 660 Standard Duty (DOUBLE CYLINDER)

KS665-3-SCAL-SCS-K2  
KS665-5-SCAL-SCS-K2

## LATCHES

### 6 Way Adjustable

#### 6 Way Core Only

KS81846-001 Deadlatch  
KS81847-001 Plain Latch  
*Face Plate Kit Required*

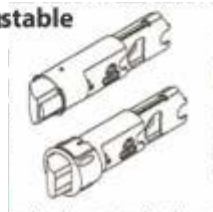

#### Deadlatch

5" Mortise

KS3014-01-3



### RC / SC / DI - Face Plate Kits

KS81844-001 For Deadlatch US3  
KS81845-001 For Plain Latch US3  
KS81844-003 For Deadlatch US26D  
KS81845-003 For Plain Latch US26D

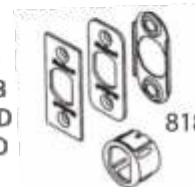

81844-001

## TITAN SERIES BOLTS

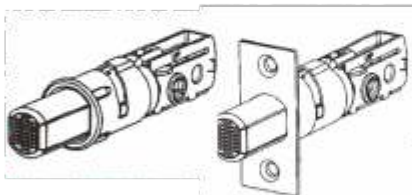

KS83371-001  
KS83370-001

Round - DI  
Square

### Deadbolts Drive-In

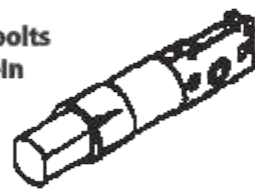





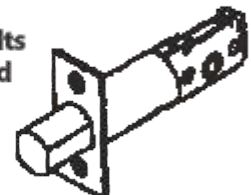







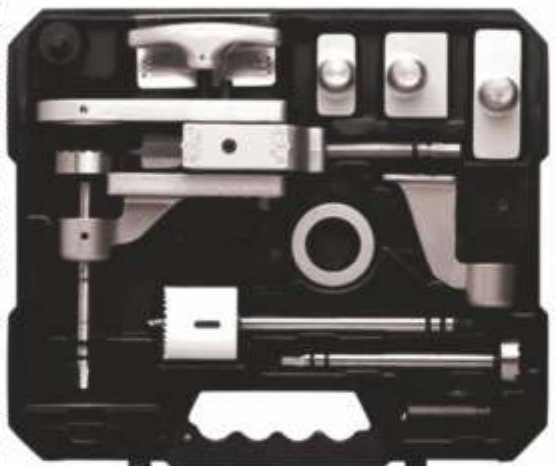

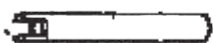
KS2734-01 Bolt 2 3/8" Drive-In 660  
KS2735-01 Bolt 2 3/4" Drive-In 660

### Deadbolts Standard



KS2728-01-3 Bolt 2 3/8" M-660  
KS2729-01-3 Bolt 2 3/4" M-660

**PARTS & ACCESSORIES**

 <p><b>Large Modernization Kit</b>                  • Two trim plates (3 1/2" x 10 1/2")                  • Latch and strike plate, for covering old style mortise locks                  • Brass                  KS214-3</p> <p><b>Small Modernization Kit</b>                  • Two trim plates (3 3/8" x 7 1/4")                  • Latch and strike plate                  • Brass                  KS215-3</p>	 <p><b>Round Rosette</b>                  • 3 7/8" for 2 3/8" or 2 1/4" backset                  KS293-3                  KS293-5                  KS293-26D</p>	
 <p><b>Kwikset Installation Kit</b>                  Heavy-duty case contains:                  • Jig                  • 2 1/8" Multi-Spur Bit                  • 1" Spade Bit                  • 2 1/8" Hole Saw                  • Hole Saw Mandrel                  • 1 1/2" Multi-Spur Bit                  • 1 1/2" Ring Adapter                  • 663 Depth Stop                  • Wood/Metal In-line Guides                  • Strike Locator                  • Mortise Tools (Strike/latch/780) W/SQ &amp;                  • Round Corner Blades                  KS138</p>	 <p><b>Cylinder Removal Tool</b>                  KS81467</p>  <p><b>Plug Follower</b>                  KS80152</p>	
 <p>KS83260-001 Smart Key Reset Cradle</p> 	<p>KS81063-009 Key Blank K-Bow NP 5-Pin                  KS81208 K-Bow NP 6-Pin Ultramax                  KS81706-US3 Screw-Pack-TH/DR-2-1/4"                  KS81804 Rekeying Tool-Titan Lever                  KS83382 Key Control Deadbolt Key Blank                  KS83559 Key Blank Oval Bow 6-Pin                  KS87615 Rekeying Tool-Titan Brass</p>	
<p><b>DEADBOLTS</b></p>		
<p>KS84220 Screw Pack, Thick Door, 880</p>  <p>KS84991 Torque Blade, 660/880, Std. Door, 2"</p>  <p>KS84992 Torque Blade, Thick Door, 660/880, 2 1/2"</p> 	<p>KS84994 Torque Blade, Thick Door, 665/885, 1 1/8"</p>  <p>KS86129-3 Screw Pack, Thick Door, 660</p>  <p>KS86130-3 Screw Pack, Thick Door, 665</p> 	<p><b>Deadbolts</b>                  KS84215 Plug Clip</p>  <p><b>Knoblocks</b>                  KS84345 Plug Clip</p>  <p><b>Deadbolts — Screw Packs</b>                  KS88197-3 Th/Dr-2 1/4", Titan Knobs/Levers</p>



## METAL REPINNING KITS

### Features:

All LAB Metal Repinning Kits for Original Lock Manufacturer's contain only those specific sizes required to service the Original Manufacturer's Cylinders. Each Kit is constructed of steel with HARDCOAT Inish & Seal-Tight Covers.



#### A2 System

##### Interchangeable Core Kit

- 10 Brass Color-Coded Bottom Pins, Sizes 0-9
- 18 Brass Master/Top Pins Sizes 2-19
- Caps and both 6 & 7 Pin Spring Covers
- 2 different length Springs: 108B-Long 108F-Short
- 2 style caps (stamped & machined)
- 3 in 1 (A2, A3, A4) key gauge
- Deep tool pocket for LAB ANNEX
- Color-coded Chart
- 11 1/8" x 8 1/4" x 2"

LABFK108



#### Kwikset

- 6 Brass Bottom Pins & 2 Brass Top Pins
- 6 Brass Master Pins
- Cylinder Springs
- Color Coded to New Industry Specifications
- Contains .160 & .180 Kwikset Anti-Pick Pins
- Includes cylinder removal tool
- Plug Follower
- Pinning/Bitting Color-coded Info Chart
- 11 1/8" x 8 1/4" x 2"

LAKPK115



#### Corbin Russwin

- Contains NEW Technical Up-to-date Pinning
- For Standard, Interchangeable Core and Master Ring Cylinders

- 67 Brass-Top Pin Sizes
- 51 Nickel-Silver Bottom Pin Sizes
- 2 Spool Pin Sizes (standard) .172 & .320
- Dual-View Pin Tray
- 21 1/2" x 8" x 1 1/2"

LALRCK6



#### Sargent

- 10 Brass Bottom Pins
- 8 Brass Master Pins
- 5 Driver Pins
- Cylinder Springs
- 11" x 8 1/4" x 1 3/4"

LASGT115



#### Schlage

- 10 Nickel-Silver Bottom Pins
- 8 Brass Master Pins & 3 Brass Top Pins
- Cylinder Cap Pins & Springs
- Cylinder Springs
- Schlage "F" series T-Pins and Springs
- Schlage Plug Follower
- New Pinning Bitting Information Chart
- 11 1/8" x 8 1/4" x 2"

LASPK115



#### Schlage & Kwikset

##### Schlage Sizes

- 10 Nickel-Silver Bottom Pins
- 8 Brass Master Pins
- 3 Brass Top Pins
- Cylinder Springs

##### Kwikset Sizes

- 6 Brass Bottom Pins & 2 Brass Top Pins
- 6 Brass Master Pins
- Cylinder Springs
- Color Coded to New Industry
- 11" x 8 1/4" x 1 3/4"

LALSK2N1



## MINI DUR-X PIN KITS

### Features:

These very handy Mini-DUR-X Pin Kits contain only LAB BRAND PINS for original lock manufacture's cylinders. Made of Super-Tough polyethylene, each kit features a platform insert with a reusable protective cover to protect contents. It contains a location chart and only those size pins and springs required to re-pin specific lock companies' cylinders.  
Size: 7" x 4 1/2" x 1 1/2"



LALMDSCH

### Schlage Cylinders

- 8 Master Pins (Brass)
- 3 Top Pins (Brass)
- 10 Bottom Pins (Nickel-Silver)
- Cylinder Cap Pins and Springs



### Ace

- 7 Brass Top Pins 1-7
- 3 Brass Bottom Pins 9-11
- Cylinder Springs

LALMDACE



### Weiser Cylinder

- 8 Master Pins
- 1 Top Pin
- 10 Bottom Pins
- Cylinder Springs

LALMDWSR



### 3-N-1 Universal Kit

This unique kit contains all color coded universal pins required to re-pin Kwikset, Schlage and Weiser.

- 3 Top Pins
- 23 Bottom Pins
- Cylinder Springs

LALMD3N1

## WEDGE PIN KITS

### Features:

The LAB WEDGE PRO and SUPER WEDGE Pin Kits are designed with a 10° angle. This allows the user to easily view the contents without leaning over the kit to select pin sizes. These WEDGE designed kits are most commonly referred to by Security Professionals as the "ULTIMATE" Pin Kits.

SUPER WEDGE comes without Pins to allow you to:

- Purchase all or only those LAB Pins you presently need
- Transfer your LAB pins from your old LAB Pin Kits directly into this new product
- Purchase the New LAB Pin Kit Refill Pack KRP003 or KRP005



LAEPK-003  
LAEPK-005

### Wedge Pro

#### EPK003

- .003 Increments
- 124 Sizes
- Top Pins: .010 - .200
- Bottom Pins: .156 - .360

#### EPK005

- .005 Increments
- 102 Sizes
- Top Pins: .010 - .300
- Bottom Pins: .150 - .360
- 21" x 7 3/4" x Front 2" Back 3"



### LA KRP003 & LA KRP005 .003 and .005 Pin Kit Refill Pack

#### KRP003

- Contains 124 packs of LAB Tumbler
- Pins 50 Pins Per Size
- Top Pins: .010 - .200
- Bottom Pins: .156 - .360

LAKRP003  
LAKRP005

#### KRP005

- Contains 102 packs of LAB Tumbler Pins
- 50 Pins Per Size
- Top Pins: .010 - .300
- Bottom Pins: .150 - .360



### Super Wedge W/ Pins/Drawer

LAEPD-003



### Classic Pro Pin Kit

LALPK003

**UNIVERSAL PINNING KITS**

<p><b>Smart Wedge Kit</b></p> <ul style="list-style-type: none"> <li>• .003 Increments</li> <li>• 92 Sizes</li> <li>• Top Pins: .24T - .200T, .235T</li> <li>• Spool Pins: .160J, .165J, .180J</li> <li>• T-Pin: .170TP</li> <li>• Bottom Pins: .159B - .354B</li> <li>• 13 1/4" x 10 1/2"</li> </ul>  <p>LALSW003</p>	<p><b>Steel Mini Kit</b></p> <ul style="list-style-type: none"> <li>• .003 Increments</li> <li>• 81 Sizes</li> <li>• Masters: .024 - .090</li> <li>• Drivers: .093 - .235</li> <li>• Bottoms: .156 - .354</li> <li>• Cylinder Springs</li> <li>• 8" x 6" x 1/4"</li> </ul>  <p>LALMK003</p>	<p><b>DUR-X Semi-Pro 3</b></p> <p>LALDKU3</p> <ul style="list-style-type: none"> <li>• .003 Increments</li> <li>• 124 Sizes</li> <li>• Top Pins: .010 - .200</li> <li>• Bottom Pins: .156 - .360</li> <li>• 22 1/2" x 8 3/4" x 2 1/4"</li> </ul> 
---	--	--

**PIN KIT ACCESSORIES**

 <p><b>LAB Annex</b> LALICCB</p>	 <p><b>Pin Stack Evictor REPL</b> LA LPE001</p>  <p><b>Capping Instrument REPL</b> LALCI001</p>	 <p><b>Lab Lube 1.0 oz</b></p> <ul style="list-style-type: none"> <li>• Made of Dupont® Teflon powder</li> <li>• A dry lubricant that will not "cake-up" as graphite does</li> </ul> <p>LALLT001</p>
<p><b>Medeco Pin Decoder Biaxial</b></p>  <p>The LAB Brand Medeco pin decoder makes it possible for the security professional to identify and sort Medeco Biaxial bottom pins according to length, angle and skew.</p> <p>LALPDMED</p>	<p><b>Cylinder Cap Removal Tool</b></p>  <p>Remove the cylinder caps from Schlage, Weiser, Arrow and Falcon cylinders</p> <p>LALCR005</p>	<p><b>LAB Pin/Work Mat</b></p>  <ul style="list-style-type: none"> <li>• 15 3/8" x 9 1/8" polyvinyl</li> <li>• Retains hundreds of loose pins</li> <li>• Molded in residential pin block area</li> </ul> <p>LALABMAT</p>
<p><b>Pin Tip Formed End Tweezers</b></p> <ul style="list-style-type: none"> <li>• Curved Ends for Positive Grip</li> <li>• Perfect Size &amp; Weight</li> <li>• Made of Stainless Steel</li> </ul>  <p>LALZT001</p>	 <ul style="list-style-type: none"> <li>*LFT004 Small Plug (.398) Dia.</li> <li>*LFT003 Corbin (.550) Dia.</li> <li>*LFT002 Weslock (.515) Dia.</li> <li>LFT001 Universal (.498) Dia.</li> <li>*LFT000 Schlage (.500) Dia.</li> </ul>	<p><b>Followers</b></p> <ul style="list-style-type: none"> <li>• Light Weight</li> <li>• Very Durable</li> <li>• White Delrin™</li> <li>• Reflects Light</li> </ul> <p>LALFT001 Universal (.498) Dia. LALFT005 5 Piece set of Followers ☐ As LFT005 Set Only Stocked</p> <p><b>Curved Shims 100/PK</b> LALSMOV100</p>



## PINS

## Features:

LAB demands and purchases only the best raw material available. Brass material is 360 alloy, full hard temper, for increased durability and cycle life. All LAB pins are inspected with the latest inspection equipment, quality systems and documented by our Quality Control Team.

## LAB Brand Original Pins

**Schlage Cylinders**

- 10 Nickel Silver Bottom Pins
- 3 Brass Driver Pins
- 8 Brass Master Pins
- Cap Retainer Pin SCHCAP

**Driver Pins**

LA34-101	Driver Pin 1	.235
LA34-102	Driver Pin 2	.200
LA34-103	Driver Pin 3	.165

**Bottom Pins**

LA34-300	Bottom Pin 0	.165
LA34-301	Bottom Pin 1	.180
LA34-302	Bottom Pin 2	.195
LA34-303	Bottom Pin 3	.210
LA34-304	Bottom Pin 4	.225
LA34-305	Bottom Pin 5	.240
LA34-306	Bottom Pin 6	.255
LA34-307	Bottom Pin 7	.270
LA34-308	Bottom Pin 8	.285
LA34-309	Bottom Pin 9	.300

**Master Pins**

LA34-202	Master Pin 2	.030
LA34-203	Master Pin 3	.045
LA34-204	Master Pin 4	.060
LA34-205	Master Pin 5	.075
LA34-206	Master Pin 6	.090
LA34-207	Master Pin 7	.105
LA34-208	Master Pin 8	.120
LA34-209	Master Pin 9	.135

**Weiser Cylinders**

- 10 Brass Bottom Pins
- 1 Brass Driver Pin
- 8 Brass Master Pins

**Driver Pins**

LA8552-0	Driver Pin	.186
----------	------------	------

**Bottom Pins**

LA8553-0	Bottom Pin 0	.168
LA8553-1	Bottom Pin 1	.186
LA8553-2	Bottom Pin 2	.204
LA8553-3	Bottom Pin 3	.222
LA8553-4	Bottom Pin 4	.240
LA8553-5	Bottom Pin 5	.258
LA8553-6	Bottom Pin 6	.276
LA8553-7	Bottom Pin 7	.294
LA8553-8	Bottom Pin 8	.312
LA8553-9	Bottom Pin 9	.330

**Master Pins**

LA8580-2	Master Pin 2	.036
LA8580-3	Master Pin 3	.054
LA8580-4	Master Pin 4	.072
LA8580-5	Master Pin 5	.090
LA8580-6	Master Pin 6	.108
LA8580-7	Master Pin 7	.126
LA8580-8	Master Pin 8	.144
LA8580-9	Master Pin 9	.162

**Kwikset Cylinders**

- Color Coded to New Industry Specifications
- 6 Brass Bottom Pins
- 5 Brass Master Pins

**Top Pins**

LA3117	Top 1T	.160
--------	--------	------

**Bottom Pins**

LA3100	Bottom Pin 1	.172
LA3101	Bottom Pin 2	.195
LA3103	Bottom Pin 3	.218
LA3105	Bottom Pin 4	.241
LA3106	Bottom Pin 5	.264
LA3107	Bottom Pin 6	.287

**Master Pins**

LA3108	Master Pin 1	.023
LA3110	Master Pin 2	.046
LA3112	Master Pin 3	.069
LA3113	Master Pin 4	.092
LA3114	Master Pin 5	.115
LA3125	Master Pin 6	.138

**Sargent Pins**

- 8 Brass Master Pins
- 5 Brass Top Pins
- 10 Brass Bottom Pins

**Top Pins**

LA13-59	Top 10	.200
LA13-60	Top 11	.220
LA13-61	Top 12	.240
LA13-62	Top 13	.260
LA13-63	Top 14	.280

**Bottom Pins**

LA13-64	Bottom 1	.170
LA13-65	Bottom 2	.190
LA13-66	Bottom 3	.210
LA13-67	Bottom 4	.230
LA13-68	Bottom 5	.250
LA13-69	Bottom 6	.270
LA13-70	Bottom 7	.290
LA13-71	Bottom 8	.310
LA13-72	Bottom 9	.330
LA13-73	Bottom 10	.350

**Master Pins**

LA13-51	Master 2	.040
LA13-52	Master 3	.060
LA13-53	Master 4	.080
LA13-54	Master 5	.100
LA13-55	Master 6	.120
LA13-56	Master 7	.140
LA13-57	Master 8	.160
LA13-58	Master 9	.180



**PINS — continued**

**Corbin Russwin Cylinders**

- 101 Brass Master / Top Pins
- 74 Nickel Silver Bottom Pins

**Top Pins**

LAM028	LAM084	LAM133	LAM205	LAM277
LAM030	LAM087	LAM135	LAM207	LAM278
LAM037	LAM090	LAM140	LAM208	LAM282
LAM040	LAM093	LAM142	LAM212	LAM289
LAM042	LAM098	LAM143	LAM213	LAM297
LAM045	LAM099	LAM147	LAM218	LAM298
LAM051	LAM100	LAM149	LAM219	LAM303
LAM053	LAM102	LAM156	LAM222	LAM320
LAM056	LAM103	LAM157	LAM226	
LAM058	LAM105	LAM163	LAM227	
LAM059	LAM107	LAM171	LAM232	
LAM060	LAM112	LAM172	LAM233	
LAM063	LAM114	LAM177	LAM237	
LAM065	LAM116	LAM184	LAM238	
LAM066	LAM118	LAM185	LAM241	
LAM069	LAM120	LAM187	LAM247	
LAM070	LAM121	LAM188	LAM252	
LAM072	LAM122	LAM191	LAM253	
LAM073	LAM126	LAM192	LAM255	
LAM075	LAM127	LAM198	LAM261	
LAM079	LAM128	LAM199	LAM263	
LAM080	LAM129	LAM202	LAM268	
LAM082	LAM132	LAM203	LAM275	
LAM083				

**Bottom Pins**

LAL160	LAL212	LAL249	LAL293	LAL337
LAL165	LAL213	LAL251	LAL294	LAL340
LAL167	LAL214	LAL256	LAL297	LAL344
LAL171	LAL217	LAL259	LAL298	LAL345
LAL174	LAL218	LAL260	LAL301	LAL349
LAL175	LAL220	LAL263	LAL304	LAL354
LAL177	LAL221	LAL267	LAL305	
LAL182	LAL226	LAL269	LAL307	
LAL185	LAL228	LAL273	LAL311	
LAL186	LAL231	LAL276	LAL315	
LAL189	LAL234	LAL278	LAL316	
LAL193	LAL236	LAL279	LAL319	
LAL198	LAL237	LAL283	LAL320	
LAL201	LAL241	LAL284	LAL322	
LAL203	LAL245	LAL287	LAL326	
LAL208	LAL246	LAL288	LAL330	
LAL210	LAL248	LAL291	LAL334	

**Spool Pins**

- LAJ172
- LAJ187
- LAJ207
- LAJ320

**PINS & SPRINGS**
**Cylinder Springs**

- All Springs Phosphor Bronze
- Universal 115L (long)
- Universal 115S (Short)
- 100 per pack
- Interchangeable Core
  - 108F (Short)
  - 108B (Long)



LA115LONG	Spring
LA115LTV1	Long Tangle Resist Spring
LA115SHORT	Spring
LA108B	Spring Best I/C (Long)
LA108BP5	Best I/C (Long) 500/bag
LA108F	Spring Falcon I/C (Short)

**Core Spring Covers**

- 2 Types Available 6 and 7 pin
- Original Design
- Brass

LAFSC6 (25PKG)	Falcon 6-PIN
LAFSC7 (25PKG)	Falcon 7-PIN

**Interchangeable Core Caps**

- Machined
- Original Specifications
- Brass
- 100 Pack Machined - 1027M

LA1027M Cap "BEST" HPC #Y21C

## PINS

**Best ICore A-2 System**

□ For Use With All Best Interchangeable Cores

*Features:*

- 100 pins per vial
- .108 Diameter Pins
- Uniquely Color-Coded for easy use
- For use in Interchangeable Core Cylinders that use Brass Key Blanks

**Brass Material****Master Pins**

LAI-.025-BRASS	2T
LAI-.037-BRASS	3T
LAI-.050-BRASS	4T
LAI-.062-BRASS	5T
LAI-.075-BRASS	6T
LAI-.087-BRASS	7T
LAI-.100-BRASS	8T
LAI-.112-BRASS	9T

**Top Pins**

LAI-.125-BRASS	10
LAI-.137-BRASS	11
LAI-.150-BRASS	12
LAI-.162-BRASS	13
LAI-.175-BRASS	14
LAI-.187-BRASS	15
LAI-.200-BRASS	16
LAI-.212-BRASS	17
LAI-.225-BRASS	18
LAI-.237-BRASS	19

**Bottom Pins**

LAI-.110-BRASS	0B
LAI-.122-BRASS	1B
LAI-.135-BRASS	2B
LAI-.147-BRASS	3B
LAI-.160-BRASS	4B
LAI-.172-BRASS	5B
LAI-.185-BRASS	6B
LAI-.197-BRASS	7B
LAI-.210-BRASS	8B
LAI-.222-BRASS	9B

**Nickel Material****Master Pins**

LAFN2TV1	2T
LAFN3TV1	3T
LAFN4TV1	4T
LAFN5TV1	5T
LAFN6TV1	6T
LAFN7TV1	7T
LAFN8TV1	8T
LAFN9TV1	9T

**Top Pins**

LAFN10TV1	10T
LAFN11TV1	11T
LAFN12TV1	12T
LAFN13TV1	13T
LAFN14TV1	14T
LAFN15TV1	15T
LAFN16TV1	16T
LAFN17TV1	17T
LAFN18TV1	18T
LAFN19TV1	19T

**Bottom Pins**

LAFN0BV1	0B
LAFN1BV1	1B
LAFN2BV1	2B
LAFN3BV1	3B
LAFN4BV1	4B
LAFN5BV1	5B
LAFN6BV1	6B
LAFN7BV1	7B
LAFN8BV1	8B
LAFN9BV1	9B

**Caps**

LAI027V1

## PINS

### LAB Brand .003 Top Pins

LA024T	LA054T	LA084T	LA114T
LA027T	LA057T	LA087T	LA117T
LA030T	LA060T	LA090T	LA120T
LA033T	LA063T	LA093T	LA123T
LA036T	LA066T	LA096T	LA126T
LA039T	LA069T	LA099T	LA129T
LA042T	LA072T	LA102T	LA132T
LA045T	LA075T	LA105T	LA135T
LA048T	LA078T	LA108T	LA138T
LA051T	LA081T	LA111T	LA141T

### LAB Brand .003 Bottom Pins

LA153B	LA183B	LA213B	LA246B	LA276B	LA306B	LA336B
LA156B	LA186B	LA219B	LA249B	LA279B	LA309B	LA339B
LA159B	LA189B	LA222B	LA252B	LA282B	LA312B	LA342B
LA162B	LA192B	LA225B	LA255B	LA285B	LA315B	LA345B
LA165B	LA195B	LA228B	LA258B	LA288B	LA318B	LA348B
LA168B	LA198B	LA231B	LA261B	LA291B	LA321B	LA351B
LA171B	LA201B	LA234B	LA264B	LA294B	LA324B	LA354B
LA174B	LA204B	LA237B	LA267B	LA297B	LA327B	LA357B
LA177B	LA207B	LA240B	LA270B	LA300B	LA330B	LA360B
LA180B	LA210B	LA243B	LA273B	LA303B	LA333B	

### LAB Brand .005 Top Pins

LA010TOP	LA060TOP	LA110TOP	LA160TOP
LA015TOP	LA065TOP	LA115TOP	LA165TOP
LA020TOP	LA070TOP	LA120TOP	LA170TOP
LA025TOP	LA075TOP	LA125TOP	LA175TOP
LA030TOP	LA080TOP	LA130TOP	LA180TOP
LA035TOP	LA085TOP	LA135TOP	LA185TOP
LA040TOP	LA090TOP	LA140TOP	LA190TOP
LA045TOP	LA095TOP	LA145TOP	LA195TOP
LA050TOP	LA100TOP	LA150TOP	LA200TOP
LA055TOP	LA105TOP	LA155TOP	

### LAB Brand .005 Bottom Pins

LA150BOT	LA205BOT	LA260BOT	LA315BOT
LA155BOT	LA210BOT	LA265BOT	LA320BOT
LA160BOT	LA215BOT	LA270BOT	LA325BOT
LA165BOT	LA220BOT	LA275BOT	LA330BOT
LA170BOT	LA225BOT	LA280BOT	LA335BOT
LA175BOT	LA230BOT	LA285BOT	LA340BOT
LA180BOT	LA235BOT	LA290BOT	LA345BOT
LA185BOT	LA240BOT	LA295BOT	LA350BOT
LA190BOT	LA245BOT	LA300BOT	LA355BOT
LA195BOT	LA250BOT	LA305BOT	LA360BOT
LA200BOT	LA255BOT	LA310BOT	



LATCH GUARDS

**LG100 Series**  
**3" X 11"**

*Cylindrical or Mortise  
Heavy 12 Gauge Plate Steel  
Reversible For Left or Right Openings  
Jamb Pin Prevents Prying the Door*

LGLG100-D Duranodic  
LGLG100Z/SF Zinc



**LG110 Series**  
**3" X 11"**

- Cylindrical
- Heavy 12 Gauge Plate Steel Reversible for Left or Right Openings
- Jamb Pin Prevents Prying the Door

LGLG110-D Duranodic  
LGLG110Z/SF Zinc  
LGLG110BB Bright Brass



**SF700 Series**

- 5/8" x 18" Thread Thru-bolt
- Meets the carriage bolt in the middle of the door
- Zinc Plated

LGLG115Z/NP  
LGSF710Z/CB



LOCK-SAVER



LUBRICANTS & CLEANERS

*Extreme Performance Lubricants - Environmentally Friendly, Non-Toxic & made in the U.S.A.*

- Lasts months instead of weeks - years instead of months
- Greatly reduces friction and wear and lubricates sticky mechanisms without gumming up or drying out
- Repels moisture and condensation and prevents corrosion and loss of performance
- Will not freeze, works well in all climates



LS60601 Aerosol 12oz Value Size



LS60151 Grease Syringe .5oz



LS60602 Aerosol 6oz Travel Size

Allegion creates peace of mind by pioneering safety and security.

Call or visit us today to speak with one of our experts about the Allegion products we carry and a solution that is right for you.



1250 Light duty



1450 Medium duty



4050 Heavy duty

## Alternative solutions, backed by LCN quality and reliability

From greater dependability to longer warranties, LCN continues to lead the door control category. With the most common hole patterns in the industry, LCN's new cast aluminum closers offer alternative solutions for a wide range of applications. These products were designed from the start to integrate the LCN engineering, quality, reliability and service that customers have come to expect from products bearing the well-known name.

**LCN**

LCN is the property of Allegion plc. All other brand names, product names or trademarks are the property of their respective owners.

**ALLEGION**   
Authorized distributor

010740 © 2016 Allegion

## 1250 SERIES



- Features:**
- Cast Aluminum Body
  - Patent Pending Design
  - Peel-n-Stick Templates
  - Universal Screw Pack
  - Full Complement Bearing
  - All Weather Fluid
  - Adjustable Spring Size 1-5
  - Non-Handed
  - 15 Year Warranty

1250 Series Door Closers		
Part No.	Description	Finish
LC1250-Rw/PA-AL	1250 TRIPACK ARM DOOR CLOSER	Aluminum
LC1250-Rw/PA-DKBRZ	1250 TRIPACK ARM DOOR CLOSER	Dark Bronze

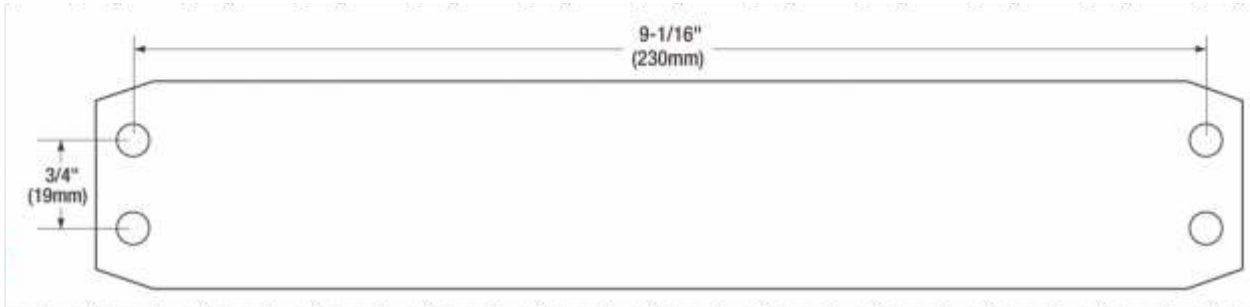

## 1260 SERIES



1260 Series Door Closers		
Part No.	Description	Finish
LC1261-CUSH-ALUM	Closer w/Cush-N-Stop arm	Aluminum
LC1261-CUSH-DKBRZ	Closer w/Cush-N-Stop arm	Dark Bronze
LC1261-RW/PA-ALUM	Closer w/Regular Arm w/PA Shoe	Aluminum
LC1261-RW/PA-DKBRZ	Closer w/Regular Arm w/PA Shoe	Dark Bronze

- Features:**
- Mounts to most common commercial footprint (3/4" x 9 1/16")
  - Standard 1260 series closer shipped with regular arm, a shaft cover, and self reaming and tapping screws
  - Non-sized (1-5) cylinder is adjustable for interior doors to 4' 6" and exterior doors to 3' 6"
  - Closer mounts hinge side, top jamb and parallel arm
  - Closer meets ADA requirements
  - Non-Handed
  - Standard powder coat finish

1260 Series Plates and Fixtures		
Part No.	Description	Finish
LC1260-18PA-AL	Plate: Parallel Arm Mount	Aluminum
LC1260-18PA-DKBRZ	Plate: Parallel Arm Mount	Dark Bronze
LC1260-18QF-AL	Plate: Quick Fix Bracket	Aluminum
LC1260-18QF-DKBRZ	Plate: Quick Fix Bracket	Dark Bronze



1450 SERIES

1450 Series Door Closers		
Part No.	Description	Finish
LC1450-Rw/PA-AL-SLIM	1450 TRIPACK ARM DOOR CLOSER	Aluminum
LC1450-Rw/PA-DKBRZ-SLIM	1450 TRIPACK ARM DOOR CLOSER	Dark Bronze



- Features:**
- Cast Aluminum Body
  - Patent Pending Design
  - Peel-n-Stick Templates
  - Universal Screw Pack
  - Full Complement Bearing
  - All Weather Fluid
  - Adjustable Spring Size 1-6
  - Non-Handed
  - 25 Year Warranty

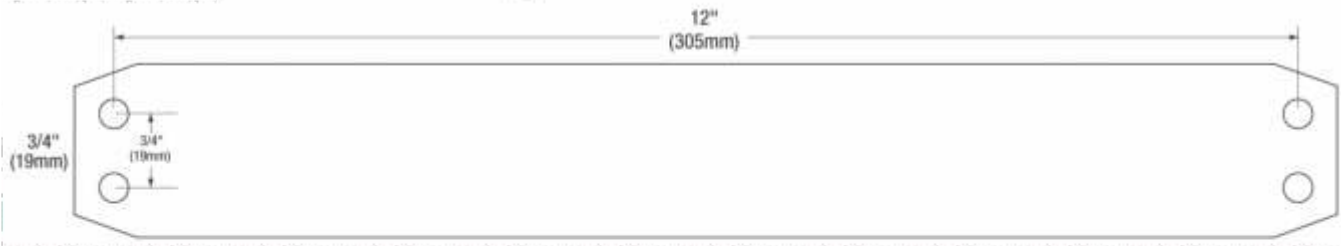

1460 SERIES

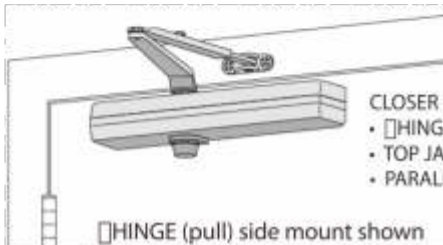

- CLOSER MOUNTS**
- HINGE (PULL) SIDE
  - TOP JAMB (PUSH SIDE)
  - PARALLEL ARM (PUSH SIDE)

HINGE (pull) side mount shown

- Features:**
- Standard 1460 series closer shipped with regular arm, a slim line plastic cover, and self reaming and tapping screws
  - Non-sized (1-6) cylinder is adjustable for interior door.
  - 5'0" and exterior doors to 4'0".
  - Closer meets ADA requirements

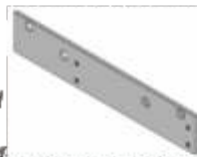

LC1460-18PA



**Mounting Plate, 1460-18**

- Required for hinge side mount where top rail is less than 2 1/2" (64 mm)
- Required for top jamb mounting where head frame is less than 1 1/8" (44 mm) or flush ceiling condition exists
- Plate requires minimum 1 1/2" (38 mm) minimum top rail 1 or 1 1/8" (32 mm) head frame

1460 Series Door Closers	
Part No.	Closer
LC1461-REG-ALUM	Closer-Adj / 1-6 Non-Handed
LC1461-REG-DKBRZ	Closer-Adj / 1-6 Non-Handed
LC1461-RW/PA-ALUM	Closer-Adj w/ PA Bracket/ 1-6 Non-Handed
LC1461-RW/PA-DKBRZ	Closer-Adj w/ PA Bracket/ 1-6 Non-Handed
LC1461-3071-ALUM	Closer Body

1460 Series Installation Accessories	
Part No.	Accessory
LC1460-18-AL	Pull Side or Top Jamb Mounting Plate
LC1460-18-DKBRZ	Pull Side or Top Jamb Mounting Plate
LC1460-18PA-AL	Push Side or Parallel Arm
LC1460-18PA-DKBRZ	Push Side or Parallel Arm
LC1460-3049-AL	Hold-Open Arm
LC1460-3077-AL	Regular Arm

## 4010 SERIES

### DOOR CLOSERS

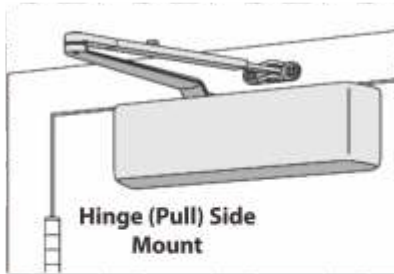

HOLD-OPEN ARM, 4010-3049

#### Features:

- Standard 4010 series closer shipped with regular arm, standard plastic cover, and self reaming and tapping screws
- Non-sized cylinder adjustable for interior doors to 4' 6" and exterior doors to 3' 6"
- Closer mounts hinge side only
- 4011 cylinder meets ADA requirements
- Handed, LH or RH
- Ten Million Cycles
- Cast Iron, Forged Steel Main Arm, Double Heat Treated Steel Pinion

Part No.	Description
LC4011-REG-LH-ALUM	Closer Non-Sized
LC4011-REG-LH-DKBRZ	Closer Non-Sized
LC4011-REG-RH-DKBRZ	Closer Non-Sized
LC4011-REG-RH-ALUM	Closer Non-Sized
LC4010-3049-LH-AL	Arm-Hold Open
LC4010-3049-RH-AL	Arm-Hold Open

## 4020 SERIES

### DOOR CLOSERS

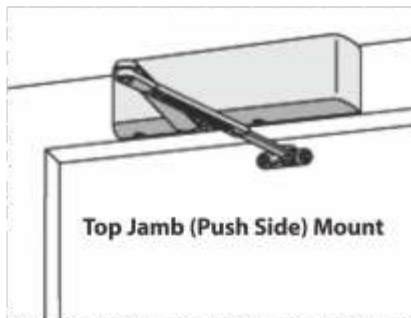

#### FEATURES

##### Features:

- Standard 4020 series closer shipped with regular arm, standard plastic cover, and self reaming and tapping screws
- Non-sized cylinder adjustable for interior doors to 4' 6" and exterior doors to 3' 6"
- Closer mounts top jamb (push side) only
- 4021 cylinder meets ADA requirements
- Handed

#### SPECIFICATIONS

- Ten Million Cycles
- Cast Iron
- Forged Steel Main Arm
- Double Heat Treated Steel Pinion
- All Weather Fluid
- LCN® Fast™ Power Adjust

Part No.	Closer
LC4021-REG-LH-ALUM	Closer-Non-Sized
LC4021-REG-LH-DKBRZ	Closer-Non-Sized
LC4021-REG-RH-ALUM	Closer-Non-Sized
LC4021-REG-RH-DKBRZ	Closer-Non-Sized

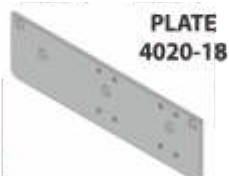

- Required where head frame is less than 3 1/8" (87 mm)
- Plate requires minimum 1 1/4" (44 mm) minimum head frame and 2" (51 mm) top rail
- 3 3/8" (98 mm) maximum reveal

### MOUNTING PLATES

Part No.	Mounting Plate	Finish
LC4020-18-AL	Top Jamb (Push Side)	Aluminum
LC4020-18-DKBRZ	Top Jamb (Push Side)	Dark Bronze

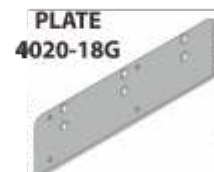

- For flush ceiling condition.
- tPlate requires minimum 1 1/4" (44 mm) mini head frame and 2 3/8" (70 mm) top rail.

4110 SERIES

DOOR CLOSERS

\*PARALLEL ARM (PUSH SIDE) MOUNT

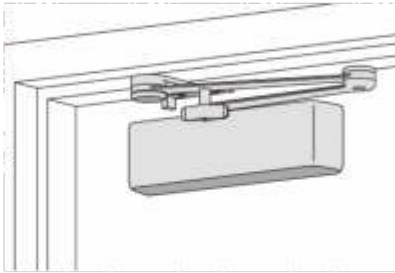

\*4110 HCUSH mount shown

Specifications:

- Cast Iron
- Extra Duty Forged Steel Arm Standard
- Double Heat Treated Steel Pinion
- All Weather Fluid
- LCN® Fast™ Power Adjust
- Standard powder coat finish

Features:

- Standard 4110 series closer shipped with EXTRA DUTY arm, standard plastic cover, 4110-201 FIFTH SCREW SPACER and self reaming and tapping screws
- Sized cylinders adjustable for interior doors to 5'0" and exterior doors to 4'0"
- Non-sized cylinder adjustable for interior doors to and exterior doors to 3'6"
- Closer mounts parallel arm, only
- 4111 cylinder meets ADA requirements
- Handed

Part No.	Closer	Finish
LC4111-CUSH-LH-ALUM	Closer-Non-Sized Adjust	Aluminum
LC4111-CUSH-LH-DKBRZ	Closer-Non-Sized Adjust	Dark Bronze
LC4111-CUSH-RH-ALUM	Closer-Non-Sized Adjust	Aluminum
LC4111-CUSH-RH-DKBRZ	Closer-Non-Sized Adjust	Dark Bronze
LC4111-EDA-LH-ALUM	Closer-Non-Sized Adjust	Aluminum
LC4111-EDA-LH-DKBRZ	Closer-Non-Sized Adjust	Dark Bronze
LC4111-EDA-RH-ALUM	Closer-Non-Sized Adjust	Aluminum
LC4111-EDA-RH-DKBRZ	Closer-Non-Sized Adjust	Dark Bronze
LC4111-HCUSH-LH-ALUM	Closer-Non-Sized Adjust	Aluminum
LC4111-HCUSH-RH-ALUM	Closer-Non-Sized Adjust	Aluminum
LC4116-EDA-LH-ALUM	Closer-Parallel Arm Mount (Push Side)	Aluminum
LC4116-EDA-RH-ALUM	Closer-Parallel Arm Mount (Push Side)	Aluminum
LC4111-SCUSH-LH-ALUM	Closer-Parallel Spring CUSH ARM	Aluminum
LC4111-SCUSH-RH-ALUM	Closer-Parallel Spring CUSH ARM	Aluminum

INSTALLATION ACCESSORIES



H-CUSH ARM 4110-3049CNS

Handed arm provides hold-open function with templated stop/hold-open points. Handle controls hold-open function.



CUSH-N-STOP ARM, 4110-3077CNS

Handed parallel arm features solid forged steel main arm and forearm with built-in stop in soffit shoe.



HOLD-OPEN ARM 4110-3049EDA

Handed arm provides hold-open function, adjustable at shoe.

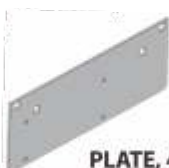

PLATE, 4110-18

Required for push side mount where top rail is less than 5 1/8" (130 mm), measured from the stop. Plate requires minimum 2" (51 mm) minimum top rail.

Part No.	Accessory	Finish
LC4110-18-AL	Mounting Plate F/Closers Parallel Arm(Push Side)	Aluminum
LC4110-18-DKBRZ	Mounting Plate F/Closers Parallel Arm(Push Side)	Dark Bronze
LC4110-18CUSH-AL	Mounting Plate F/Closers Parallel Arm(Push Side)	Aluminum
LC4110-18CUSH-DKBRZ	Mounting Plate F/Closers Parallel Arm(Push Side)	Dark Bronze
LC4110-3049CNS-AL	LH or RH Hold-Open Arm	Aluminum
LC4110-3049EDA-LH-AL	Arm-Hold Open (HEDA)	Aluminum
LC4110-3049EDA-RH-AL	Arm-Hold Open (HEDA)	Aluminum
LC4110-3077CNS-AL	Non-Handed Cush-N-Stop Arm	Aluminum
LC4110-3077SCNS-AL	Spring Cush Arm	



## 4040XP SERIES



### DOOR CLOSERS

**LCN®**  
4040XP/4041DA  
Pull Side Mount  
128° TEMPLATE

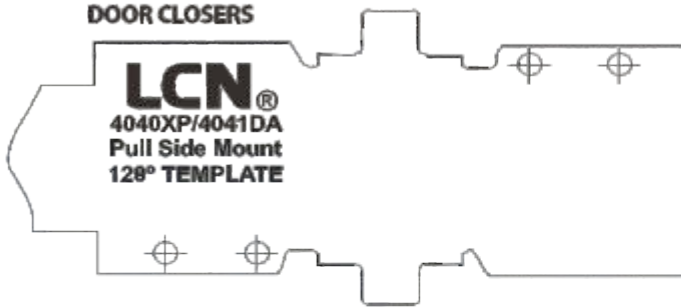

#### LCN 4040 XP SERIES

Extra protection for doorways that suffer from heavy use and abuse — perfect for both indoor and outdoor applications, even in extreme situations such as harsh weather or teenagers.

#### Features:

- Strongest Pinion Ever - At ¾", it's the Super Hero of Pinions
- Taller Bearings - 5/8", real muscle against forced openings and closings
- Overall 44% increase in Max. load capacity
- Tougher Teeth - fight wear and tear
- V-Shield Seal with 20% longer life

Part No.	Closer	Finish
LC4040XP-CUSH-AL	XP Closer Adj / 1-6	Aluminum
LC4040XP-CUSH-DKBRZ	XP Closer Adj / 1-6	Dark Bronze
LC4040XP-H-ALUM	XP Closer Adj / 1-6	Aluminum
LC4040XP-H-DKBRZ	XP Closer Adj / 1-6	Dark Bronze
LC4040XP-HCUSH-ALUM	XP Closer Adj / 1-6	Aluminum
LC4040XP-HCUSH-DKBRZ	XP Closer Adj / 1-6	Dark Bronze
LC4040XP-SCUSH-AL	XP Closer Adj / 1-6	Aluminum
LC4040XP-SHCUSH-ALUM	XP Closer Adj / 1-6	Aluminum
LC4040XP-REG-ALUM	XP Closer Adj / 1-6	Aluminum
LC4040XP-REG-DKBRZ	XP Closer Adj / 1-6	Dark Bronze
LC4040XP-RWPA-TBSRT-AL	XP Closer Adj / 1-6 W/Thru Bolts	Aluminum
LC4040XP-RW/PA-AL	XP Closer Adj / 1-6	Aluminum
LC4040XP-RW/PA-DKBRZ	XP Closer Adj / 1-6	Dark Bronze
LC4041-DEL-REG-ALUM	Closer-Adj/1-6 Delay Action	Aluminum
LC4040XP-3071-ALUM	Closer Body	Aluminum

### MOUNTING PLATES

#### PLATE, 4040-18

Required for hinge side mount where top rail is less than 3 ¾" (95 mm). Plate requires minimum 2" (51 mm) minimum top rail

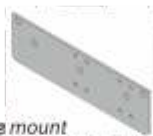

#### PLATE, 4040-18G

Locates top jamb mounted closer flush with top of head frame face in flush ceiling condition. Plate requires 1 ¾" (44 mm) minimum head frame.

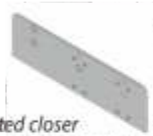

#### PLATE, 4040-18PA

Required for parallel arm mounting where top rail is less than 5 ½" (140 mm), measured from the stop. Plate requires 2" (51 mm) minimum top rail.

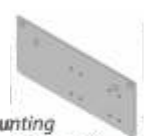

#### PLATE, 4040-18TJ

Centers top jamb mounted closer vertically on head frame where face is less than 3 ½" (89 mm). Plate requires 1 ¾" (44 mm) minimum head frame.

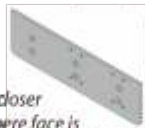

Part No.	Accessory	Finish
LC4040-18-AL	Pull Side or Top Jamb Mounting Plate	Aluminum
LC4040-18-DKBRZ	Pull Side or Top Jamb Mounting Plate	Dark Bronze
LC4040-18G-AL	Pull Side or Top Jamb Mounting Plate	Aluminum
LC4040-18G-DKBRZ	Pull Side or Top Jamb Mounting Plate	Dark Bronze
LC4040-18PA-AL	Parallel Arm Mounting Plate	Aluminum
LC4040-18PA-DKBRZ	Parallel Arm Mounting Plate	Dark Bronze
LC4040-18TJ-AL	Mounting Plate-Top Jamb (Push Side)	Aluminum
LC4040-18TJ-DKBRZ	Mounting Plate-Top Jamb (Push Side)	Dark Bronze

**4040 SERIES INSTALLATION ACCESSORIES**



**3077EDA  
3049EDA**

**EXTRA DUTY ARM**

• Features forged, solid steel main and forearm for potentially abusive installations



**HOLD-OPEN ARM - 4040-3049**

• Optional, non-handed arm mounts pull side or top jamb with shallow reveal, hold-open adjustable shoe

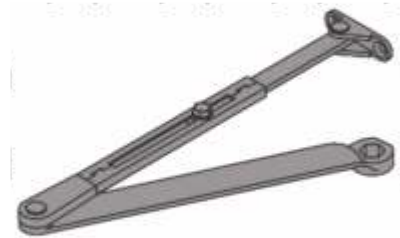

**REGULAR ARM - 4040-3077**

• Non-handed arm mounts pull side or top jamb with shallow reveal

**HOLD-OPEN EXTRA DUTY ARM  
4040-3049EDA**

• Handed arm provides hold-open function, adjustable at the shoe

Part No.	Description	Finish
LC4040-3077EDA-AL	Extra Duty Arm	Aluminum
LC4040-3049EDA-LH-AL	LH Hold-Open Extra Duty Arm	Aluminum
LC4040-3049EDA-RH-AL	RH Hold-Open Arm EDA	Aluminum
LC4040-3049-AL	Hold-Open Arm	Aluminum
LC4040-3049-DKBRZ	Hold-Open Arm	Dark Bronze
LC4040-3049CNS-AL	HCush Arm	Aluminum
LC4040-3077-AL	Regular Arm	Aluminum
LC4040-3077-DKBRZ	Regular Arm	Dark Bronze
LC4040-3077CNS-AL	Cush-N-Stop Arm	Aluminum
LC4040-TB/MS4EA-AL	Thru Bolt/Machine Screw - Pkg. of 4 Ea.	Aluminum
LC4040-TB/MS4EA-DKBRZ	Thru Bolt/Machine Screw - Pkg. of 4 Ea.	Dark Bronze
LC4040-30-AL	Cush Shoe Support	Aluminum
LC4040-30-DKBRZ	Cush Shoe Support	Dark Bronze
LC4040-61-AL	Blade Stop Spacer	Aluminum
LC4040-61-DKBRZ	Blade Stop Spacer	Dark Bronze
LC4040-62PA-AL	Parallel Arm Shoe	Aluminum
LC4040-62PA-DKBRZ	Parallel Arm Shoe	Dark Bronze
LC4040-72-AL	Cover Standard Snap-on	Aluminum
LC4040-72-DKBRZ	Cover Standard Snap-on	Dark Bronze
LC4040-79-AL	Rod & Shoe	Aluminum
LC4040-79LR-AL	Long Rod & Shoe	Dark Bronze



**PA SHOE - 4040-62PA**

Required for parallel arm mounting



**4040-TB/MS4EA**

• Thru Bolt /  
• Machine Screw  
• Package of 4 each

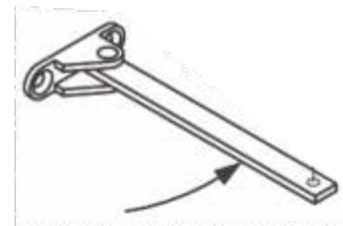

**ROD & SHOE, 79**  
6 3/8" (162 mm)

**LONG ROD & SHOE, 79LR**  
8 3/8" (213 mm).

**CUSH SHOE SUPPORT - 4040-30**

Provides anchorage for fifth screw used with CUSH arms, where reveal is less than 3 1/8" (78 mm)

**BLADE STOP SPACER - 4040-61**

Required to lower parallel arm shoe to clear 1/2" (13 mm) blade stop

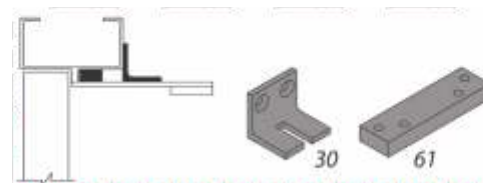



## 4040SE SERIES

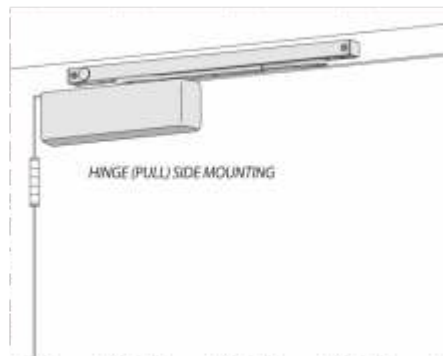

### 4040SE SENTRONIC™ SERIES

The 4040SE SENTRONIC™ is a heavy duty, closer/holder designed to provide single point hold-open for fire and smoke barrier doors. The door is held open until current interruption releases the holding mechanism and the door closes. Single lever (track) arm closer is specifically designed for interior doors.

**LC 4040SE-STD-120V-ALUM**  
**LC 4040SE-STD-24V-ALUM**

### Features:

- Standard 4040SE series closer shipped with a standard arm, 24V or 120V (please specify) SE track, standard cover, and wood and machine screw pack
- Non-sized cylinders for interior doors to 4'0"
- Hold-open force is adjustable
- Momentary on/off switch board assembly for testing door release also provides over-voltage protection. Field replaceable
- Functions as a full rack and pinion closer when hold-open is not engaged or current is interrupted
- Closer mounts on either push or pull side of the door
- Non-handed
- Concealed or surface wiring
- Interfaces with alarm systems

### INSTALLATION ACCESSORIES



**TRACK SLIDER 4040SE-168**  
 Alloy metal slider for use in SE series tracks only

Part No.	Description	Finish
LC4040SE-3034SE	Track Roller with Slider	
LC4040SE-3038-24V-AL	Standard Track	Aluminum
LC4040SE-3038-120V-AL	Standard Track	Aluminum

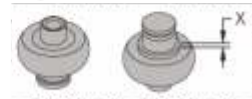

**TRACK ROLLER, 4040SE-3034**

- Quiet, low friction roller assembly
- Shoulder dimension "X" = 1/8" (3 mm)

## 4630 ELECTRIC SERIES



### CLOSER AUTO-EQUALIZER (Aluminum) LC 4631-MC-STD-120V-AL

#### Specifications:

- NEW Digital Control Suite
- Utilizes a 10 Million Cycle Heavy
- Duty Door Closer
- On-Board Diagnostics
- On-board Power Supply
- Factory-Default Memory
- Plug-and-Play Connections
- No Destruct Feature
- No Guard Rails or Safety Mats Required

### Features:

- Standard, top jamb (pull side) mounted 4630 series closer shipped with single lever (standard) arm, metal cover, standard track, and wood and machine screw pack
- Non-sized cylinders for interior doors to 4'0" and exterior doors to 3'0"
- Non-handed
- Easily accessible switches provide on/off and continuous hold-open functions. Control module provides all timing and sequential door functions, electric strike controls and adjustments for opening speed and force

## 4640 ELECTRIC SERIES

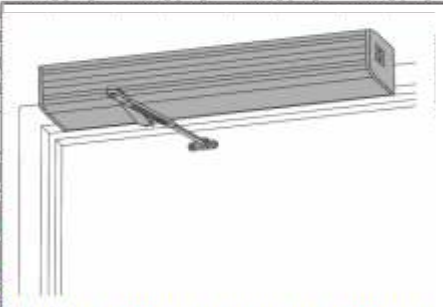

### TOP JAMB (PUSH SIDE) MOUNTING

#### Features:

- Standard, top jamb (push side) mounted 4640 series closer shipped with regular arm, metal cover, and wood and machine screw pack
- Non-sized cylinders for interior doors to 4'6" and exterior doors to 3'6"

### • Non-handed

- Standard powder coated finish, end caps are black.

Part No.	Description	Finish
LC4642-REG-120V-AL	Closer Auto-Equalizer	Aluminum
LC4642-REG-120V-DKBRZ	Closer Auto-Equalizer	Dark Bronze
LC4642-3971-AL	Cylinder Only	Aluminum



## 4820 PNEUMATIC SERIES



The 4820 AUTO-EQUALIZER™ is LCN's pneumatically powered MULTI-DOOR solution. This low-energy power operator is designed primarily for manual opening applications that occasionally require automatic opening.

- Utilizes a 10 Million Cycle
- Heavy Duty Door Closer
- Quiet, Efficient & Reliable
- Requires Control Boxes with integral compressor or control box

**Features:**

- Ideal for multi-door applications since cost per door or leaf decrease significantly as the number of door leaves increases
- Standard, plate mounted 4820 series closer shipped with regular arm, metal cover, and wood and machine screw pack
- Non-sized cylinders for interior doors to 4'6" and exterior doors to 3'6"
- Non-handed
- Requires additional system components
- Standard custom powder coated finish, end caps are black

Part No.	Description	Finish
LC4822-MC-REG-ALUM	Closer Auto-Equalizer	Aluminum
LC4822-MC-REG-DKBRZ	Closer Auto-Equalizer	Dark Bronze
LC925	Tubing- Roll of 100ft.	

## ACCESSORIES

The actuators and accessories are to be used only with LCN electromechanical power operators. When using actuators supplied by others, such as card readers, consult the factory.

### WALL MOUNTED ACTUATOR LC8310-856

- Features:**
- Hardwired
- Features:**
- 4 1/2" (114mm) diameter
- Features:**
- Mounts in flush or surface box (sold separate), or single gang electrical box Vandal/weather resistant - stainless steel



### JAMB MOUNTED ACTUATOR LC8310-818T

- Features:**
- Hardwired
  - 1 1/2" (38mm) x 4 3/4" (121mm)
  - Mounts in frame cut-out or flush box Vandal/weather resistant - stainless steel



### DOOR MAGNET TRI-VOLTAGE LOW PROFILE REC WALL MNT LCSEM7840-AL

### SURFACE MOUNT KIT LC8310-3856WS



- WIRELESS KIT INCLUDES:**
- 4 1/2" round actuator
  - Transmitter
  - Surface box
  - Weather ring
  - Requires 8310-865 receiver (not included)

### RECEIVER LC8310-865

- Features:**
- Wireless
  - T channel
  - Use with 8310-3856WS Kit



### FORCE GAUGE

LCADA-FG



**Instructions:**

1. Locate "o" ring on the plunger rod and set to zero by pushing down against the flange.
2. Open the door enough to overcome any initial forces from air pressure and latch devices. Place plunger end of the gauge perpendicular to the door just above the door opener/trim. Holding gauge firmly, use slow steady pressure against door to open.
3. Take the force reading from the side on the "o" ring closest to the flange.



### LCPAINT-CS DKBRZ

- LCN Spray Paint; designed to match standard powder coat colors; dark anodized bronze.

### HEX WRENCH LCGHW



## ELECTROMECHANICAL HARDWARE



LNC450-LBM-32D



LNDC-AL-20



LNDKP-165



LNDKP-165-S



LNEGB-100-R



LNIPB-100



LNIPB-300



LNMG1200

LNC450-32D	CYL STRIKE 9/16" 12/24D
LNC450-LBM-32D	CYL STRIKE 9/16" 12/24D LBM
LNC5750-32D	CYL STRIKE 3/4" 12/24D
LNC5750-LBM-32D	CYL STRIKE 3/4" 12/24D LBM
LNCSFP-KIT-10B	FACEPLATES (2) 4-7/8 x 1-1/4"
LNC5LE-1	1" LIP EXTENSION
LNC5LE-2	2" LIP EXTENSION
LNC5W-100	CONCEALED SWITCH FLUSH MOUNT
LNC5W-200	CONCEALED SWITCH NARROW
LNCWFP-KIT-10B	FACEPLATE RADIUS CORNER
LNCWFP-KIT-32D	FACEPLATE RADIUS CORNER
LNDC-AL-20	DOOR CORD MED DUTY 20" ALUM
LNDC-BR-20	DOOR CORD MED DUTY 20" US10B
LNDC-HD-16	DOOR CORD HEAVY DUTY 16"
LNDC-PL-12	DOOR CORD LIGHT DUTY 12"
LNDC-PL-20	DOOR CORD LIGHT DUTY 20"
LNDKP-165	DIGITAL KEYPAD INTERIOR
LNDKP-165-FM	DIGITAL KEYPAD FLUSH MOUNT
LNDKP-165-S	DIGITAL KEYPAD SURFACE MOUNT
LNEGB-100-G	EMERGENCY BREAK GREEN CASE
LNEGB-100-R	EMERGENCY BREAK RED CASE
LNEGB-COV	REPLACEMENT COVER FOR EGB
LNEGB-KEY	REPLACEMENT KEY FOR EGB
LNEMS-100	EXIT MOTION SENSOR
LNIPB-100	ILLUMINATED 2" PUSHBUTTON
LNIPB-100-N	ILLUMINATED 1.5" BUTTON NARROW
LNIPB-300	PUSH TO EXIT MUSHROOM STYLE
LNIPB-300-N	PUSH TO EXIT MUSHROOM NARROW
LNMF50	1/2" FILLER PLATE MG 600/1200
LNMF63	5/8" FILLER PLATE MG 600/1200
LNMG1200	1200 LB INTERIOR MAG 12/24D
LNMG1200DT	1200 LB INTERIOR MAG 12/24D
LNMG600	600 LB INTERIOR MAG 12/24D
LNMG600DT	600 LB INTERIOR MAG 12/24D
LNMLBK1200	L-BRACKET FOR MG1200
LNMLBK600	L-BRACKET FOR MG600

**ELECTROMECHANICAL HARDWARE**



LNMS100-32D



LNPPH-50



LNPPH-200-LED



LNRS300-F-32D



LNTB-36



LNTS-100



LNWMG1200



LNWS-200

LNMPB-100	PUSHBUTTON METAL PUSH-TO-EXIT
LNMPB-100-N	PUSHBUTTON METAL PUSH-TO-EXIT
LNMS100-32D	MORT STRIKE 12/24D
LNMS100-F-32D	MORT STRIKE 12/24D FIRE
LNMS100-F-LBM-32D	MORT STRIKE 12/24D LBM FIRE
LNMS100-LBM-32D	MORT STRIKE 12/24D LBM
LNMSFP-KIT-10B	FACEPLATE KIT 5 PIECES
LNMBK	U-BRACKET MG SERIES GLASS DOOR
LNMBK1200	Z-BRACKET FOR MG1200
LNMBK600	Z-BRACKET FOR MG600
LNPPH-100-AL	PUSH PLATE HANDICAP ROUND
LNPPH-100-PL	PUSH PLATE HANDICAP ROUND
LNPPH-200-LED	PUSH PLATE HANDICAP DUAL LED
LNPPH-50	PUSH PLATE HANDICAP NARROW
LNRS200-10B	RIM STRIKE 1/2" 12/24D
LNRS200-32D	RIM STRIKE 1/2" 12/24D
LNRS300-10B	RIM STRIKE 3/4" 12/24D
LNRS300-32D	RIM STRIKE 3/4" 12/24D
LNRS300-F-10B	RIM STRIKE 3/4" 12/24D FIRE
LNRS300-F-32D	RIM STRIKE 3/4" 12/24D FIRE
LNTB-36	TOUCHBAR 36" DOOR ALUMINUM
LNTB-42	TOUCHBAR 42" DOOR ALUMINUM
LNTB-48	TOUCHBAR 48" DOOR ALUMINUM
LNTBR-100	TIMER-BUZZER RECTIFIER
LNTS-100	TOUCH SENSE SWITCH SPDT
LNTS-100-N	TOUCH SENSE SWITCH SPDT NARROW
LNWFP50	1/2" FILLER PLATE FOR WMG
LNWFP63	5/8" FILLER PLATE FOR WMG
LNWLBK1200	L-BRACKET FOR WMG1200
LNWLBK600	L-BRACKET FOR WMG600 SERIES
LNWMG1200	1200 LB WEATHER RES MAG 12/24D
LNWMG600	600 LB WEATHER RES MAG 12/24D
LNWS-200	WAVE SENSE SWITCH FLUSH MOUNT
LNWS200-MB	WAVE SENSE SWITCH SURFACE BOX
LNWZBK1200	Z-BRACKET FOR WMG1200
LNWZBK600	Z-BRACKET FOR WMG600



KEYSHAPES



LL34005S  
Wall Display 72 Pieces

LL34007E  
Key Shapes Extender Rack

1 Box of 5 Carded Blanks

- LLB101K Kwikset USA Flag
- LLB101S Schlage USA Flag
- LLB102K Kwikset Diamond Ring
- LLB102S Schlage Diamond Ring
- LLB103S Schlage Money
- LLB104K Kwikset Peace Sign
- LLB104S Schlage Peace Sign
- LLB105K Kwikset Home
- LLB105S Schlage Home
- LLB106K Kwikset Flower Bee
- LLB106S Schlage Flower Bee
- LLB107K Kwikset Rose
- LLB107S Schlage Rose
- LLB108K Kwikset Red Wine
- LLB108S Schlage Red Wine
- LLB109K Kwikset Margarita
- LLB109S Schlage Margarita
- LLB110K Kwikset Beer Mug
- LLB110S Schlage Beer Mug
- LLB111K Kwikset Ice Cream
- LLB111S Schlage Ice Cream
- LLB112K Kwikset Palm Tree
- LLB112S Schlage Palm Tree

- LLB113K Kwikset Beach
- LLB113S Schlage Beach
- LLB114K Kwikset Dog
- LLB114S Schlage Dog
- LLB115K Kwikset Cat
- LLB115S Schlage Cat
- LLB116K Kwikset Race Flag
- LLB116S Schlage Race Flag
- LLB117K Kwikset Fishing
- LLB117S Schlage Fishing
- LLB118K Kwikset Rifle
- LLB118S Schlage Rifle
- LLB119K Kwikset Golf Club
- LLB119S Schlage Golf Club
- LLB120K Kwikset Baseball
- LLB120S Schlage Baseball
- LLB121K Kwikset Football
- LLB121S Schlage Football
- LLB122K Kwikset Hammer
- LLB122S Schlage Hammer
- LLB123K Kwikset Wrench
- LLB123S Schlage Wrench
- LLB125K Kwikset Music
- LLB125S Schlage Music

- LLB126K Kwikset Tape Measure
- LLB126S Schlage Tape Measure
- LLB127K Kwikset Earth
- LLB127S Schlage Earth
- LLB130K Kwikset Hockey
- LLB130S Schlage Hockey
- LLB131K Kwikset Teacher
- LLB131S Schlage Teacher
- LLB132K Kwikset Cowboy
- LLB132S Schlage Cowboy
- LLB133K Kwikset Martini
- LLB133S Schlage Martini
- LLB135K Kwikset Soccer
- LLB135S Schlage Soccer
- LLB136K Kwikset Sugarskull
- LLB136S Schlage Sugarskull
- LLB137K Kwikset Buddha
- LLB137S Schlage Buddha
- LLB138K Kwikset Artist
- LLB138S Schlage Artist
- LLB140K Kwikset Lollipop
- LLB140S Schlage Lollipop
- LLB141K Kwikset Dog Tags
- LLB141S Schlage Dog Tags

- LLB142K Kwikset Gardening
- LLB142S Schlage Gardening

KEY SHAPES

- LLB143K Kwikset Battle Axe
- LLB143S Schlage Battle Axe
- LLB144K Kwikset Dagger
- LLB144S Schlage Dagger
- LLB145K Kwikset Dragon
- LLB145S Schlage Dragon
- LLB146K Kwikset Skeleton
- LLB146S Schlage Skeleton

FORGED KEY SHAPES

- LLB301K Kwikset Sword
- LLB301S Schlage Sword
- LLB302K Kwikset Knife
- LLB302S Schlage Knife

KEY IDENTIFIERS & ORGANIZATION PRODUCTS — continued



Size: 9" W x 6" L x 1 3/4" H  
LL61500 Pegboard Sleeve

**Key Case™**

- Trim and compact, our Key Case™ is a smart, stylish way to store 6 sets of keys
- Ideal for home, office or garage, it mounts easily to the wall without noticeable bulk. The latch keeps the organizer tightly closed
- Distinctively designed in a pearlized white with a key embossed into the front panel



Size: 10 1/4" W x 3 1/4" L x 5/8" H  
LL60700

**Wavy Key Rack™**

- Add pizzazz to home, office or garage
- Multiple racks can be stacked to create key center
- Easy to install - includes adhesive pads for wall mount & two punch-out holes for permanent installation (screws not included)
- Supplied in a stylish pearlized white to complement office or home décor
- Seven hooks hold up to seven sets of keys



LL91901

**Sprinkler Key Hider**

- Looks like a regular sprinkler head
- Tough water-tight plastic case
- Holds multiple keys
- Push it into the dirt around shrubs or walkways
- 12 per Counter Display Box

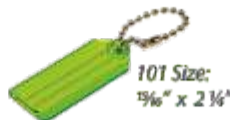

101 Size:  
3 1/2" x 2 1/4"  
LL10102 (2 Card)  
LL10124 (24 Card)  
LL10100 (100 Display)

**KeyTag w/Ball Chain**

- Durable, transparent tag for keys or luggage
- Paper insert slides out easily
- Heavy-duty 4 1/2" nickel-plated steel ball chain
- 101 Colors: clear, blue, green, magenta, purple, red, orange, & yellow



60502 open  
60502



60500

**Key Tag w/Split Ring**

- Open/close flap over paper insert for identification with keys attached.
- Durable tag for keys. Also fits key tag racks. Made of tough polypropylene.
- Paper insert comes out for easy writing.
- No. 605 has 7/8" tempered steel split key ring.
- Boxes measure only 9" x 3".
- Colors: clear, blue, green, magenta, purple, red, orange, & yellow
- Size: 1 3/4" x 2 1/4"
- LL60500
- LL60502



60500  
LL12302 (2 Card)  
LL12300 (100 Display)  
Size: 3/8" x 2 1/4"

**Key Tag w/Tang Ring**

- Durable, transparent tag for keys or luggage.
- Paper insert slides out easily.
- Nickel-plated tempered steel tang ring allows key removal without damage to fingernails.
- Colors: clear, blue, green, magenta, purple, red, orange, & yellow



Size: 3/8" x 2" (with 3/4" overlapping ring and swivel)

**Key Tag with Swivel Ring**

- Flexible tag with metal swivel.
- Paper insert slides out easily. Clear plastic insert protects writing from the elements.
- Colors: black, blue, green, purple, red, & yellow
- LL16800 (200/Box)
- LL16802 (2 Card)



Size: 1-1/8" x 2-1/4"

**Key Tag w/Split Ring**

- Preferred tag of car rental companies.
- Tough plastic resists breakage.
- Durable tag for keys. Also fits key tag racks.
- Paper insert slides out for easy writing.
- 7/8" nickel-plated tempered steel split key ring.
- Color: clear
- LL20400 (100 Display)
- LL20402 (2 Card)



Size: 7/8" x 2" (with 3/4" overlapping ring)

**Key Tag with Ring**

- Flexible, colored plastic tag ideal for multi-key systems.
- Paper insert slides out easily. Clear plastic insert protects writing from the elements.
- Colors: black, blue, green, purple, red, & yellow
- LL16900 (200 Display)



Size: 10" W x 2 1/2" L x 1/2" H

**8-Key Tag Rack**

- Rugged plastic rack keeps key tags organized.
- Mount with adhesive strips or screws (included).
- Colors: white with assorted color tags
- LL60580



Size: 10" W x 2 1/2" L x 1/2" H

**4-Key Tag Rack**

- Rugged plastic rack keeps key tags organized.
- Supplied with four tags and adhesive strips to mount anywhere
- Colors: white with assorted color tags
- LL60540



**Key Caps**

- Neon Colors: pink, green, orange, & yellow
- Regular Colors: black, dark blue, blue, green, magenta, purple, red, & yellow
- LL16500 (200 Display)
- LL16504 (4 Card)
- LL16507 Neon (200 Display)



**KEY IDENTIFIERS & ORGANIZATION PRODUCTS — continued**



16200  
Box Display

16225  
Jar Display



**House Key Cap**

- Makes a house key easy to find and easy to grip.
- Unique design inside cap accommodates Schlage, Kwikset and Weiser key heads.
- Vinyl resists tearing and color fading.
- Superior material is pliable, but won't break.
- Neon Colors: pink, green, orange, & yellow
- Regular Colors: black, blue, green, magenta, purple, red, & yellow

LL16200 100/Box Assorted Colors  
 LL16207 100/Box Neon Colors  
 LL16225 100/Jar Assorted Colors

Size: 1 1/4" x 1"



**One Hole Label-It™ Plastic Tags**



- 25/CLAM
- More durable than paper, our tag is water-resistant.
- Tag has a 1 1/8" recess for our custom die-cut labels or permanent marker write-on space.
- Clamshell includes blank and pre-formatted paper labels. Templates are downloadable from [www.luckyline.com/labels](http://www.luckyline.com/labels). Instructions included.
- Each tag has a 3/8" dia. key ring.
- Colors: white, blue, lime, melon, lilac, lemon, & magenta

LL25029



Size: 1 1/4" dia.

**6-Key Tag Rack**

- Scalloped design adds style to a popular item
- Organize keys for home, office, cars, school, family
- Store keys in one convenient location
- Easy to install - includes adhesive tape for mounting
- No. 60560 supplied in white with six assorted color No. 605 tags
- No. 60562 is supplied in charcoal gray with six clear No. 605 tags

LL60560  
 LL60562



Size: 8" W x  
 2 3/8" L x 1/2" H

**Key Identifiers  
 No. 164, 166, 167**

- Available in small, medium and large sizes.
- Keeps similar keys separated by color
- Will stretch to fit over most standard key heads for easy key identification
- Rubber-like vinyl resists cracking and color fading. Superior material; pliable, but won't break
- Not recommended for ignition keys
- Neon Colors: pink, green, orange, & yellow
- Regular Colors: black, blue, green, magenta, purple, red, yellow, & dark blue (small only)

**MEDIUM**

- LL16700 Key Asst. (200 Display)
- LL16704 Key Asst. (4 Card)
- LL16707 Neon Key Asst. (200 Display)
- LL16720 Reill Black (50/PKG)
- LL16730 Reill Blue (50/PKG)
- LL16740 Reill Green (50/PKG)
- LL16746 Reill Neon Green (50/PKG)
- LL16756 Reill Neon Orange (50/PKG)
- LL16765 Reill Dark Purple (50/PKG)
- LL16766 Reill Neon Pink (50/PKG)
- LL16770 Reill Red (50/PKG)
- LL16780 Reill Yellow (50/PKG)
- LL16786 Reill Neon Yellow (50/PKG)



**SMALL**

LL16400 Key Asst. (200 Display)



**LARGE**

- LL16615 Key Asst. (150 Display)
- LL16617 Key Asst. Neon (150 Display)
- LL16620 Reill Black (50pkg)
- LL16630 Reill Blue (50pkg)
- LL16640 Reill Green (50pkg)
- LL16665 Reill Dk Prp (50pkg)
- LL16670 Reill Red (50pkg)



**KEY IDENTIFIERS & ORGANIZATION PRODUCTS — continued**



LL61200

Size:  
8 1/2" W x 10 1/2" L x 1 3/4" H

**Key Organizer**

- Rugged polypropylene key cabinet organizes keys for home, business or garage.
- Has 24 numbered hooks to coordinate with identification label inside.
- Friction latch keeps cabinet closed tightly.
- No. 61200 supplied with two keys; uses Elgin 21 key blank and has 24 numbered hooks to coordinate with identification label inside.
- Supplied in beige with mounting screws and instructions.
- Color: beige



Sizes: 3/4", 1", 1 1/4", 1 3/4", 1 3/8", and 1 7/8" dia.

**Solid Brass Tags**

- Solid brass tags for heavy-duty applications.
- Can be stamped or engraved.
- .040" thick.
- Colors: brass

LL26006 Tag 3/4" (100/Box)  
LL26010 Tag 1" (100/Box)  
LL26011 Tag 1 1/4" (100/Box)  
LL26012 Tag 1 3/8" (100/Box)



Sizes: 1 1/4" dia.

**Paper Tags**

- Sturdy metal-rimmed white paper tags.
- No. 280 series has overlapping ring attached.
- Ideal as price tags or product identification tags.
- Colors: white

LL28229 Paper Tags (25/Clamshell)



**Aluminum Tags**

- 1-hole, color-coded tags for many uses, indoors & out.
- Can be stamped or engraved.
- Colors: black, blue, red, purple, & aluminum
- Size: .040" thick, 1 1/4" dia.

LL25630 1 Hole Blue (100/Box)  
LL25670 1 Hole Red (100/Box)  
LL25693 1 Hole Aluminum (100/Box)



Open to Clip

**Quik Clip™**

- Flexible plastic always retains its shape.
- Ergonomic design comfortably fits in hand.
- Inside hook keeps key ring secure.
- Clips to belt loop or purse.
- Colors: black, lemon, lilac, magenta, lime, melon, & blue

Size: 2 3/8" (without split ring)

LL45801 Assorted (1 Card)  
LL45824 Assorted (24/EaselCard)

**KEY IDENTIFIERS & FUNCTIONAL KEY ACCESSORIES**



Size: 2"x 3"

**Squeeze Coin Holder**

- Coin holder doubles as a key chain.
- Flexible plastic opens with a simple squeeze to accept coins, closes tight when released.
- Supplied with 4 1/2" nickel plated steel ball chain.
- Colors: blue, green, red, yellow, neon, & orange

LL94101 Assorted (1 Card)



**Leather Belt Hook**

- Durable leather belt hook features a clip for key removal and 1 1/8" nickel plated tempered steel split ring.
- Snap allows for easy removal from belt or purse.
- Colors: brown leather & black leather
- Size: 6" (overall length)

LL45201 w"/J" Clip Assorted (1 Card)  
LL45301 w"/J" Clip Assorted (12 Card)









Size: 6" (w/o split ring),  
adjusts to 7 1/2"

**Nylon Key Guard with Clip**





- Key guard with snaps attaches to purse or belt, or loops over wrist.
- Snaps to two different lengths.
- Tough plastic "J" clip holds 1 1/8" nickel plated tempered steel split ring and makes key removal simple.
- Durable, lightweight nylon webbing meets military specifications.
- Colors: black

LL41801 w"/J" Clip Assorted (1 Card)

**KEY IDENTIFIERS & FUNCTIONAL KEY ACCESSORIES — continued**

 <p><b>Lanyard</b></p> <ul style="list-style-type: none"> <li>Made of strong woven nylon.</li> <li>Colors: black, blue, &amp; red</li> <li>Size: 21 1/2" length</li> </ul> <p>LL41401 Assorted (1 Card) LL41412 Assorted (12 Card)</p>	 <p><b>Rock Key Hider</b></p> <p>Closed Open</p> <ul style="list-style-type: none"> <li>Sturdy molded plastic resists damage in all-weather conditions.</li> <li>Color: gray &amp; brown</li> <li>Size: 3" (overall length)</li> </ul> <p>LL90601 Rock Key Hider (1 Card)</p>	 <p><b>3-Way Pull Apart</b></p> <ul style="list-style-type: none"> <li>3-way pull apart key holder</li> <li>Supplied with three 3/8" nickel-plated tempered steel split key rings.</li> <li>Supplied with a steel body and red and blue anodized aluminum ends.</li> <li>Size: 4" (overall length)</li> </ul> <p>LL71501 Nickel Plated Brass (1 Card) LL71701 Anodized Aluminum (1 Card)</p>
 <p><b>Wrist Coil</b></p> <ul style="list-style-type: none"> <li>Superior quality coil always springs back and never loses its shape.</li> <li>Fits comfortably over wrist for work, exercise, water sports, etc.</li> <li>3/8" nickel plated tempered steel split ring.</li> <li>Neon Colors: pink, green, &amp; yellow</li> <li>Regular: black, dark blue, teal, purple, &amp; red</li> <li>Size: 2" dia. (stretches to 12" dia.)</li> </ul> <p>LL41001 Assorted (1 Card) LL41006 Neon Assorted (1 Card) LL41012 Assorted (12 Card)</p>	 <p><b>Key Buoy</b></p> <ul style="list-style-type: none"> <li>Durable key holder floats up to 5 keys easily.</li> <li>Red and white sections make it highly visible, easy to find on water or snow.</li> <li>Bottom half separates to provide a watertight storage compartment for identification, fishing license or cash.</li> <li>Plastic with 6" nickel-plated brass chain.</li> <li>Size: 4" long x 1 1/4" dia.</li> </ul> <p>LL92101 Key Buoy-w/ball (1 Card) LL92112 Key Buoy-w/ball (12 Card)</p>	 <p><b>Quick Release</b></p> <ul style="list-style-type: none"> <li>Pull-apart key holder makes it easy to leave keys with valets, family, friends, etc.</li> <li>Nickel plated brass with two 3/8" nickel-plated tempered steel split key rings.</li> <li>Size: 3" (overall length)</li> </ul> <p>LL70701 Quick Release (1 Card) LL70712 Quick Release (12 Card)</p>

**KEY ACCESSORIES**

 <p><b>Soft Key Float</b></p> <ul style="list-style-type: none"> <li>Soft foam key holder floats up to 5 keys easily.</li> <li>Neon colors make it highly visible and easy to find on water or snow.</li> <li>Made of vinyl-coated foam with a 6" nickel-plated brass ball chain that won't rust.</li> <li>Colors: bright orange &amp; bright yellow</li> <li>Size: 3 1/2" x 1 3/8" x 1"</li> </ul> <p>LL92801 Yellow (1 Card) LL92812 Yellow (12 Card) LL92401 Orange (1 Card)</p>	 <p><b>Large, Extra Large &amp; Jumbo</b> Magnetic Key Hider</p> <ul style="list-style-type: none"> <li>Large key hider holds two large keys</li> <li>Extra large key hider holds large, rubber headed keys</li> <li>Jumbo key hider fits x-large &amp; rubber headed keys</li> <li>Made of rugged black plastic</li> <li>Will not rust</li> <li>2 heavy-duty, superior magnets hold to any steel surface</li> <li>Ideal for use on all vehicles, or any magnetic surface where you want to hide a key for emergencies</li> <li>Colors: Black (with silver imprint)</li> <li>910 Size: 3" x 1 3/8" x 3/8"</li> <li>912 Size: 4" x 2 3/8" x 3/8"</li> <li>915 Size: 4 3/8" x 2 3/8" x 3/8"</li> </ul> <p>LL91001 Regular (1 Card) LL91010 Regular (10 Card) LL91200 Extra Large (6 Box) LL91201 Extra Large (1 Card) LL91210 Extra Large (10 Display) LL91501 Jumbo (1 Card) LL91506 Jumbo (6 Box) LL91510 Jumbo (10 Card)</p>	 <p><b>Wallet Key Hider</b></p> <ul style="list-style-type: none"> <li>Durable plastic, sized to fit in a wallet.</li> <li>Holds two standard keys or one large headed key.</li> <li>Keeps spare keys readily accessible.</li> <li>Colors: black (with silver imprint)</li> <li>Size: 3 3/8" x 2 1/8" (credit card size)</li> </ul> <p>LL90901 Black Plastic (1 Card)</p>
 <p><b>Pouch Key Hider</b></p> <ul style="list-style-type: none"> <li>Tear-resistant nylon pouch attaches keys or cash to non-magnetic surfaces.</li> <li>Water-resistant adhesive anchors mounting pad to any clean surface.</li> <li>Effective hook and loop system secures pouch to pad, makes pouch removal easy.</li> <li>Colors: black (with teal imprint)</li> <li>913 size: 2 3/4" x 4" x 1/8"</li> <li>914 size: 2" x 4" x 1/8"</li> </ul> <p>LL91301 Extra Large (1 Card) LL91401 Large (1 Card) LL91410 Large (10 Card)</p>		 <p><b>Key Release</b></p> <ul style="list-style-type: none"> <li>Keeps keys organized on separate rings.</li> <li>Can be removed individually.</li> <li>Slide keys to notched opening and press button to release. Colors: black.</li> <li>Made of tough plastic with five removable 1/4" tempered steel key rings.</li> </ul> <p>LL42701 Assorted (1 Card)</p>



KEY ACCESSORIES — continued

 <p><b>Thumb Lite</b>                  LL90701 1/Card                  LL90700 Box of 25                  907 size: 3/4" x 3/8" x 3/16"</p>	<p>Key Savers fits in the Key Saver portfolio</p>  <p><b>Key Savers</b></p> <ul style="list-style-type: none"> <li>• Designed to carry a spare office, house and/or car key to prevent lock-outs</li> <li>• Clear sleeves. Colors: white</li> <li>• Same size as a credit card to fit in your wallet</li> <li>• No. 916 holds two standard keys.</li> <li>• No. 917 holds one large and one standard key</li> <li>• Size: 3 3/4" x 2 1/8" (credit card size)</li> </ul> <p>LL91601 2 Standard Keys (1 Card)                  LL91701 1-Standard 1-Large(1 Card)</p>	 <p><b>Remote Skins</b></p> <ul style="list-style-type: none"> <li>• Made of soft, water-resistant neoprene.</li> <li>• Tough, clear vinyl window provides high visibility of remote buttons.</li> <li>• Slip the cover over a broken remote to make broken remotes usable again.</li> </ul> <p>LL48800 Remote Skin Display                  LL48801 Remote Skin Ford                  LL48901 Remote Skin GM                  LL49001 Remote Skin Universal</p>
 <p><b>Mini-Bak Badge Holder</b></p> <ul style="list-style-type: none"> <li>• Durable, high-impact plastic case &amp; 3-strand nylon cord with a badge-holder</li> <li>• 1" Dia. 3 ft. extension. Holds up to 2 oz</li> </ul> <p>LL42801 Mini-Bak Clip (1 Card)</p>	<p><b>Graphite Lubricant</b></p>  <p>LL95001 4.5 Grams</p> <p>LL34400 Large Key Accessory Kit                  LL34401 Small Key Accessory Kit                  LLU34000 Utilicarry Counter Display                  LLU34006 Utilicarry 3-Tier Display</p>	

BELT KEY CARRIERS

 <p><b>Secure-A-Key® Slip On</b></p> <ul style="list-style-type: none"> <li>• Patented double locking arm prevents accidental key loss.</li> <li>• Supplied with 1 3/8" nickel-plated tempered steel split ring.</li> <li>• Colors: Stainless Steel</li> <li>• Size: 2" (without split ring)</li> </ul> <p>LL40501 Slip-On SS (1 Card)</p>	 <p><b>Secure-A-Key Wide Belt</b></p> <ul style="list-style-type: none"> <li>• Supplied in black color, made of stainless steel - fits up to 2 1/4" wide belts.</li> </ul> <p>LL47001 (1 Card)                  LL47012 (12 Card)</p>	 <p><b>Super 48 Key Bak®</b></p> <ul style="list-style-type: none"> <li>• Kevlar® cord</li> <li>• Unique ball-and-socket locking mechanism holds multiple keys. Carry more keys, small tools or phone.</li> <li>• Heavy-duty polycarbonate case will not rust.</li> <li>• Includes a Lifetime Service Policy.</li> <li>• Colors: black</li> <li>• Size: 2 1/4" x 3 1/2" (w/o split ring)</li> </ul> <p>LL43651 Super 48 (1 Card)</p>  <p>LL4335 Super 48 w/ 2 1/2" LTHR LOOP</p>
 <p><b>Okay's Key Safe</b></p> <ul style="list-style-type: none"> <li>• Slips through belt so it won't pull off.</li> <li>• Made of nickel-plated steel.</li> <li>• Heavy-duty polycarbonate case will not rust.</li> <li>• 1 1/8" nickel plated tempered steel split ring snaps in and out with ease.</li> <li>• Colors: Nickel</li> <li>• Size: 2" (without split ring)</li> </ul> <p>LL47601 (1 Card)                  LL47612 (12 Card)</p>	 <p><b>Key Bak® 48" Kevlar®</b></p> <ul style="list-style-type: none"> <li>• Includes a Lifetime Service Policy</li> <li>• Colors: textured chrome</li> <li>Size: 2 1/2" dia.</li> </ul> <p>LL43751 Clip-On (1 Card)</p>	 <p><b>Gearkeeper</b></p> <ul style="list-style-type: none"> <li>• 360° rotating stainless steel belt clip</li> <li>• Quick connect split ring allows keys to be connected and disconnected</li> <li>• Holds 15+ keys. Extends 42" (with locking) and has 80 lb. breaking strength.</li> <li>• Colors: Black</li> <li>• Size: 2" x 4" (without split ring)</li> </ul> <p>LL47301 High Force Key Reel (1 Card)</p>
 <p><b>Secure-A-Key® Clip On</b></p> <ul style="list-style-type: none"> <li>• Spring stainless steel</li> <li>• Patented double-locking arm</li> <li>• Supplied with 1 3/8" nickel plated</li> <li>• Tempered steel split ring</li> <li>• Colors: Stainless Steel</li> <li>Size: 2" (without split ring)</li> </ul> <p>LL40401 Clip-On SS (1 Card)                  LL40412 Clip-On SS (12 Card)</p>	 <p><b>Key Bak®</b></p> <ul style="list-style-type: none"> <li>• Clip on belt or Slip through belt</li> <li>• Includes a Lifetime Service Policy</li> <li>• Colors: textured chrome &amp; black</li> <li>Size: 2 1/2" dia.</li> </ul> <p>LL43301 Slip-On (1 Card)                  LL43501 Clip-On (1 Card)                  LL43551 Spinner Slip-On (1 Card)</p>  <p>LL463P Kit 25 PCS W/ Free Display</p>	



**BELT KEY CARRIERS — continued**



**Plastic Key Clip**

- Supplied in assorted colors with 7/8" nickel-plated tempered steel split ring
- Bulk packs of 144 available in all colors
- Colors: black, blue, teal, neon pink, purple, red, & neon yellow
- Size: 3 1/2" (without split ring)

LL41501 Assorted (1 Card)  
LL41536 Assorted (36 Card)



**Designer Key Coil**

- Bulk packs of 100 available in all colors. Neon Colors: yellow & pink. Regular Colors: black, bright blue, teal, purple, & red
- Size: 10" (stretches to 48")

LL41601 Assorted (1 Card)  
LL41612 Assorted (12 Card)



**Trigger Snap**

- Strong trigger snap opens wide to attach securely to belt loop, purse or other straps
- Bottom loop rotates so keys lie flat
- 1 1/8" nickel-plated tempered steel split ring
- Colors: nickel & brass
- Size (w/o split ring): 2 1/2" (zinc)
- Size (w/o split ring): 2 3/4" (brass)

LL44001 Solid Brass (1 Card)  
LL44101 Nickel-Plated Zinc (1 Card)



**Bolt Snaps**

- Nickel plated zinc and solid brass
- Colors: nickel & brass
- Size: 445 - 2 1/2" (w/o split ring)
- Size: 450 - 3" (w/o split ring)
- Size: 451 - 3 1/2" (w/o split ring)

LL44501 Small Bolt Snap (1 Card)  
LL49001 Bolt Snap Brass (1 Card)  
LL45101 Bolt Snap NPZ (1 Card)  
LL45112 Bolt Snap NPZ (12 Card)



**6 1/2" Pocket Chain**

- Use with Secure-A-Key® or Belt Hook
- Supplied with two nickel-plated tempered steel split key rings: 3/8" and 1 1/8"
- Color: Nickel

LL40301 (1 Card)



**Mini Designer Coil**

- Superior quality coil always springs back, never loses its shape.
- Small nickel plated trigger snap keeps keys on belt loop, book bag or purse strap.
- Clip trigger snap to key ring to create convenient wrist coil for carrying keys.
- Neon Colors: pink, green, & yellow
- Regular Colors: black, dark blue, teal, purple & red
- Size: 4" (stretches to 24")

LL41301 Assorted (1 card)



**Belt Hook**

- 1 1/8" nickel plated tempered steel split ring
- Colors: nickel
- Size: 2 3/8" (without split ring)

LL40601 Hook Clip on (1 Card)



**Skeleton Keys**

- For use on French doors and other antique door hardware
- Brass plated zinc
- Generic cuts are designed to fit most antique door locks
- Size: 3 1/4" (length)

LL87202 Flat & Notch Tip (2 Card)



**C-Clip Counter Display**

126 Pieces Large/Small Assorted Colors  
(Not made for Climbing)

LL46000 Counter Display LG/SM

**SMALL DISPLAY REFILLS**

- LL46020 C-Clip Small Black
- LL46030 C-Clip Small Blue
- LL46040 C-Clip Small Green
- LL46065 C-Clip Small Dark Purple
- LL46070 C-Clip Small Red
- LL46093 C-Clip Small Silver

**LARGE DISPLAY REFILLS**

- LL46120 C-Clip Large Black
- LL46130 C-Clip Large Blue
- LL46140 C-Clip Large Green
- LL46165 C-Clip Large Dk Purple
- LL46170 C-Clip Large Red
- LL46193 C-Clip Large Silver



LLA502L Tough Links 3 1/4" Snap



**C-Clip**

- Spring-loaded
- Clips to belt or purse
- Made of anodized aluminum
- No. 460 has a 7/8" nickel-plated tempered split key ring
- No. 461 has a 1 1/8" ring
- Colors: black, blue, green, purple, red, & silver

LL46001 Small (1 Card, inner pack 5)  
LL46101 Large (1 Card, inner pack 5)

KEY RINGS & CHAINS



880 Crimper Tool permanently closes ring



**Locking Cable Key Ring**

- Strong, flexible, corrosion-resistant aircraft cable key ring.
- Use as key ring or binder ring to hold products or documents together
- Available in these finishes: brass-plated stainless steel, stainless steel, slim stainless steel, nylon-coated cable and monofilament
- Colors: clear, black, blue, purple, red, & green
- Standard Size: 4 1/2" length
- Custom lengths and colors available

LL80820	4" Cable Black
LL80830	4" Cable Blue
LL80870	4" Cable Red
LL88100	Crimping Tool for 808XX



**Ball Chain**

- Pre-cut ball chain with connector attached
- Keeps keys securely together
- Chain ball locks into end of connector to close
- Made of nickel-plated steel
- Color: Nickel
- Sizes: 4 1/2" long

LL31424	#6 NPS#(24 Card)
---------	------------------



**Stainless Steel Neck Chain No. 316**

- Fits over neck to hold medallion, tags or keys
- Made of stainless steel that will not corrode
- Color: Nickel
- Size: 24" long, 3/16" dia.

LL31601	SS/Ball (5/PKG)
---------	-----------------



**Pull Apart Ring**

- To open, apply pressure upward & outward
- Note: Downward angle permits locking
- Sturdy steel key ring holds numerous keys, can hang on hook for storage.
- Tension closure sleeve permits ring to lock together.
- To open, pull ends up and apart.
- Ideal for extra keys, or temporary storage of customer's key rings.
- Made of 1/8" diameter cadmium-plated steel.
- Color: Silver
- Sizes: 3 1/2" CC/Steel (2 Card)

LL74300	3 1/2" CC/Steel (25 Per Box)
---------	------------------------------



**Flex-o-Loc**

- Strong, flexible, corrosion-resistant aircraft cable key ring.
- Unique patented ball-knob and socket closure locks and unlocks easily.
- Use as key ring or binder ring to hold products or documents together.
- Available in these finishes: brass-plated stainless steel, stainless steel, slim stainless steel, nylon coated cable and monofilament.
- Colors: clear, black, blue, magenta, red, & teal
- Size: 5" length

LL71101	Nylon Coated (1 Card)
LL73101	Stainless Steel (1 Card)



**Nickel-Plated Tempered Steel Ring**

- Key rings hold multiple keys securely.
- Resilient tempered steel won't lose shape even after repeated use.
- Made of nickel-plated tempered steel.
- Color: Nickel
- Size: 3" diameter

LL76000	1/2" Split (100 Box)
LL76100	3/8" Split (100 Box)
LL76200	5/8" Split (100 Box)
LL76300	7/8" Split (100 Box)
LL76400	1" Split (100 Box)
LL76500	1 1/8" Split (100 Box)
LL76600	1 1/4" Split (100 Box)
LL76700	1 3/8" Split (100 Box)
LL76800	1 1/2" Split (50 Box)
LL76900	1 5/8" Split (50 Box)
LL77000	2" Split (50 Box)
LL79100	3" T/Split (25 Box)
LL79101	3" Split

**Nickel-Plated Tempered Steel Ring**



Qty.	Size
40	1/2"
40	3/8"
40	5/8"
40	7/8"
40	1"
30	1 1/8"
30	1 1/4"
30	1 3/8"
25	1 1/2"
25	1 5/8"
25	2"

- Counter display sits on counter or hangs on pegboard or slat wall.
- Holds 365 pieces ( 1/2" - 2" dia. )
- Dimensions: 6"(w) x 13"(h) x 6"(d)

LL36500	Key Ring-Display (365/DSP)
---------	----------------------------



**Twisty Key Ring**

- Strong, flexible, corrosion-resistant aircraft cable key ring.
- Unique patented locking mechanism assures keys stay put.
- Use as key ring or binder ring to hold products or documents together.
- Available in these finishes: brass-plated stainless steel, stainless steel, slim stainless steel, nylon-coated cable and monofilament.
- Colors: black, blue, green, purple, red, & clear
- Custom lengths and colors available
- Standard Size: 5" length
- #829 Size: 9" length

LL84101	Twisty 5" Stainless Steel SS
---------	------------------------------



**Give Away Ring**

- Ideal as giveaway with cut keys.
- Made of zinc plated steel spring wire with a 1/4 turn overlap.
- All sizes use .0475" gauge wire.
- Color: Steel
- Sizes: " and 1" diameters

LL75600	3/4" ZPS (1000/BX)
LL75900	1" ZPS (1000/BX)



**Spring Sleeve**

- Compact key ring with screw or springloaded closures.
- Pull to open, release to close.
- Color: Nickel
- Sizes: 3/4" x 2"

LL70401	Key Ring NPS(1 Card)
---------	----------------------



**Anodized Oval Key Ring**

- Sleek, colored aluminum key ring keeps keys easily in pocket or purse.
- Brass screw closure makes taking keys on and off simple and fast.
- All sizes use .0475" gauge wire.
- Colors: Blue, green, purple, red, & silver
- Sizes: 2 3/8" long

LL73701	Assorted Rings (1 Card)
---------	-------------------------



**ACCESSORIES**



Fits Over Knob  
Locks To Block  
Out Existing Keys!

Uses Chicago Key Blank K4

**Kee-Blok**

Blocks All Existing Keys To A Knob Lock in Seconds! Portable! Light! Strong!

- Fits 90% Of All Knob Locks.
- Fits Many Popular Models Of Knob Locks.
- Prevents Entry Of Any Existing Keys.
- Portable! Fits In The Palm Of Your Hand.
- Added Protection! A New Lock In Just Seconds.
- High Strength Aluminum Alloy.
- Silver Powdercoat

MMA100-KA-MMC3 Aluminum KA

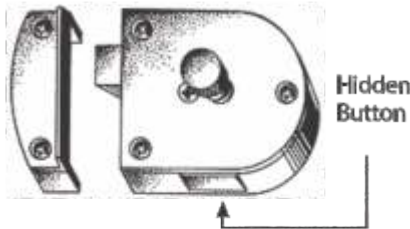

Hidden  
Button

**Secret Gate Latch**

Puzzling To The Unwelcome!

- Hidden button in bottom of case retracts latch for the informed.
- Exposed dummy knob frustrates the unwelcome intruder.
- For use on "bank type" office gates where minimum security is required.
- Supplied with strike plate, mounting screws
- Approximate case size is 2" x 2 1/2"

MMS200-SPA Sprayed Aluminum  
MMS200-SPB Sprayed Brass

**The Door Jamb Reinforcer**

Whether it's damaged by a crow bar break-in or someone's carelessness with heavy equipment slamming into the door frame, "Jamb Jacket" is the minimal cost solution.

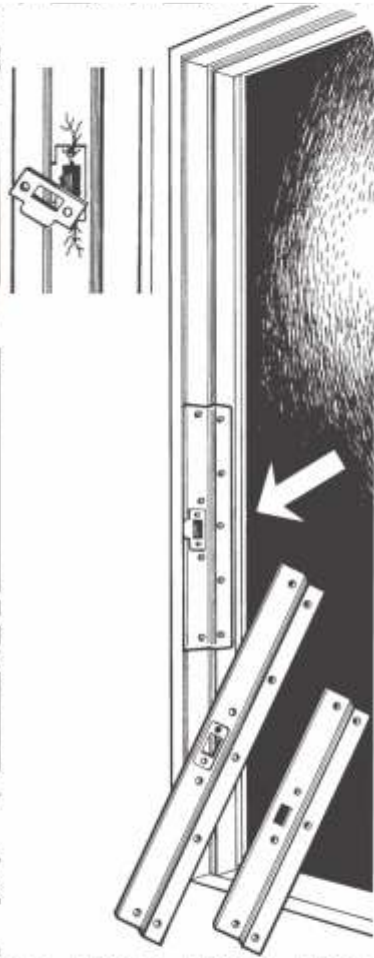

**Jamb Jacket**

- Repairs and covers damaged and splitout door jambs without the expense of replacing the whole jamb
- Adds reinforcement to healthy undamaged jambs for additional security
- Non-handed. Can be used on right or left hand doors
- Designed to cover standard 1/2" rabbeted jamb
- Finished in Beige Powdercoat finish for durability. (May be repainted to match existing frame)
- "Jamb Jacket" is recessed to accommodate T-strike. Available in 24" length for 1 3/8" and 1 3/4" doors. Supplied with strike plate and mounting screws

MMJL-134-24 For 1 3/8" Door  
MM JL-138-24 For 1 3/4" Door



Installation at base of sliding patio door



Installation at top of center or side of sliding door



Ideal For: Sliding Patio Doors, Sliding Windows, Swinging Doors, Double Doors, French Doors, Plus:

- Can be used on narrow stile doors and frames with a frame width of only 1 1/8"
- Lock housing will accept a standard 1 3/8" mortise cylinder (not included) enabling it to be keyed to other locks in a system.
- Mounts at top or bottom of door or both.
- Equipped with a 9" long locking bolt with a 2 3/8" throw as standard.
- Each lock is supplied with a #1 gear (for use with standard mortise cylinders) locking rod, one way screws and instructions.

MM5002-1-9A Octopod 9" Rod Alum  
MM5002-1-9D Octopod 9" Rod Duro  
MM5002-1-9W Octopod 9" Rod White

**Octopod Replacement Parts**



- 5002-GR1: Standard Cam Gear, supplied with screws and washers.  
5002-GR2: Medeco Cam Gear, supplied with screws and washers.
- MM5002-GR1 Gear Standard  
MM5002-GR2 Gear Standard



**Safe Door Hinge Shim Kit**

This handy assortment contains 10 each of 9 different sizes of precision brass hinge shims. They are used to shim worn safe hinges in order to raise a safe door back to the proper height, and prevent it from dragging. The kit is packaged in a plastic box for convenient storage, and each thickness is color coded for easy identification.  
Refills: OD = 1 1/16" ID = 7/16" Thickness 0.020

MMHSK-10 Hinge Shim Kit



## INSTALLATION TOOLS

### Tubular Latch in Hollow Metal Door



The LMB-01 will make installing cylindrical knob locks or dead-bolts on metal doors now faster and easier than ever. The LMB-01 mounting bracket is stamped from 12 gauge cold rolled steel for strength, installed with pop-rivets for convenience, and supplied with an adhesive template for accuracy. The LMB-01 mounting bracket is also cut out in the center to allow installations on metal doors with a center seam.

The template is marked for 1" and 1 1/2" faceplate cutouts as well as for bracket mounting holes and center lines to locate the crossbore. LMB-01 is supplied complete with template and steel pop-rivets.

MMLMB-01 Bracket-w/Template

### LMB-089 Installation Tool

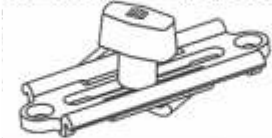

Quickly locate and install LMB-08 brackets with the LMB-089 Installation Tool. Brackets are screwed to installation tool to prevent them from slipping off during installation. Once brackets and tool are inserted into door channel, brackets are rotated 90 degrees and will lock in the correct position for installation.

Simply slide tool to top of the faceplate cutout, tighten bracket in place, remove the holding screw, slide tool to bottom of cutout, tighten bottom bracket, and remove holding screw & tool.

MMLMB-089 Bracket-w/Template

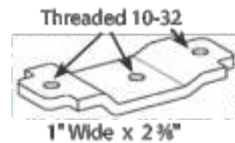

LMB-03  
Universal  
Mounting  
Bracket

1" Wide x 2 3/8"



LMB-05

1 3/8" Wide x 1 1/2"

- MMLMB-03 Bracket Tapped
- MMLMB-034 Bracket for Bevel
- MMLMB-05 1 1/4" x 4 3/8" ASA strikes
- MMLMB-100 Lock Mounting Brackets

## GUARD PLATES



### AG5-A & AG5-D Aluma Guard

Our new Aluma-Guard is designed to protect aluminum framed, glass, store front doors. It forms a shield that will protect both the latch area from attack and the lock cylinder from wrenching. The AG-5 is formed from cold rolled steel that is 6 1/2" high, 3 1/2" wide & 3/16" thick. Mounting is easy with one carriage bolt in the top and a drive rivet in the bottom and can be installed with the lock still in the door. Available in aluminum and duranodic powdercoat finishes.

- MMAGS-A Aluminum
- MMAGS-D Duranodic Powdercoat



### Cylinder Guards

- Stops a Wrench from Gripping & Crushing!
- Forms a cone of hardened steel protection for rim and mortise cylinders
- Free-spinning, tapered cone shape.
- Resistant to channel locks, vise grips, pipe wrenches, etc.
- Tough, hardened steel for durability.
- Wave washer supplied to eliminate sloppiness of installation.
- Finishes: Aluminum Powdercoat™ (A) or "Duranodic Powdercoat"™ (D)

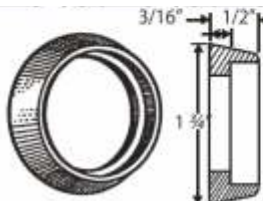

- MMCGA-5 Cylinder Guard (PKG/5)
- MMCGD-5 Cylinder Guard (PKG/5)

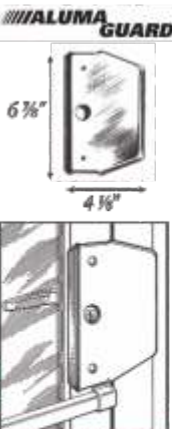

### AG1-A & AG1-D Aluma Guard

Forms a Shield of Armor on Latch/Cylinder of Out-Swinging Aluminum Framed Glass Doors.

- Protects aluminum framed glass doors against: caseknife, jimmying, cylinder pulling and wrenching, door and frame separation
- Completely covers area of door and frame near lockbolt to prevent caseknife attack
- Protects cylinder pulling, wrenching and lockbolt from being jimmied
- Anchor frame pads help prevent door jamb separation
- Heavy gauge steel "Aluma-Guard" is easily installed with anchor pads and through bolts without lock removal
- Dimensions: 6 3/8" H x 4 1/8" W
- Finishes: Aluminum Powdercoat™ (A) or "Duranodic Powdercoat"™ (D)

- MMAG1-A
- MMAG1-D

### Aluma Guard ADA

Offset Cylinder Hole for Ada Mounted Locks and Push Bars



RH Shown

The same high security Aluma Guard plate as our standard AG-1 model except for an offset cylinder hole that allows installing on doors where the lock is mounted closer to the push bar. The distance from the top of the plate to the center of the 3/8" diameter cylinder hole is 2 3/8". Models available for both left and right hand mounting.

- Finishes: Aluminum Powdercoat™ (A) or "Duranodic Powdercoat"™ (D)
- (L) Mounts on left side of door
- (R) Mounts on right side of door

- MMAG3L-A
- MMAG3L-D
- MMAG3R-A
- MMAG3R-D

**LOCKSMITH TOOLS**

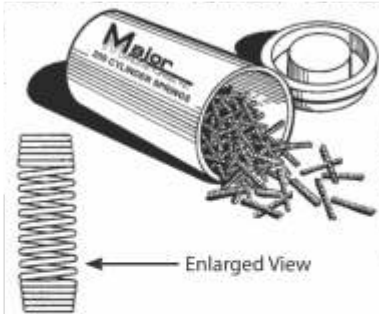

**Tangle Resistant Cylinder Springs**  
Tangle resistant cylinder springs by Major Manufacturing are not tangle proof, but they resist tangling common with standard springs. Use our springs wherever you use standard size springs. Because they are more closely wound and contain more coils overall than other springs, they resist tangling and provide greater compression on the pin stacks.

MMTRS-250 Springs (250/PKG)

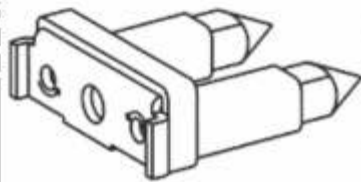

For use on narrow style aluminum doors only.

**LMB-08 Mounting Bracket**

For Adams Rite Style Locks  
LMB-08 supplied with adapters to conform to flat, radius or bevel face doors. Never be without the right bracket.  
Build-in screw jacks eliminate slipping, twisting and screw stripping during installation. Screw jack uses a 3/16" allen hex wrench for positive "no-slip" wrenching during installation. Solid steel 3/8" square diameter screw jack posts. Built-in #8-32 pre-threaded lock mounting nut prevents stripped mounting holes. Two brackets with #8-32 mounting screws per pack.  
For fast, easy no error installations, use LM-089 Installation Tool.



To use the LMB-08 for flat face door channel use two #2 Caps.  
To use the LMB-8 for bevel face door channel use #1 Cap on the low side and #3 Cap on the high side

MMLMB-08 Bracket f/Adams Rite

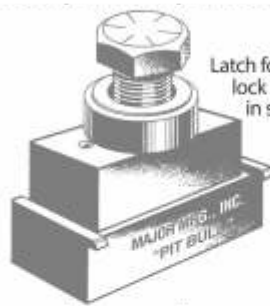

Latch forming tool for lock installations in steel doors

**MDLT-1 "Pit Bull"**

The Pit Bull tool is used to form a rectangular pocket in the edge of a hollow metal door. Application of the tool is almost effortless - simply drill the latch and cross bore holes and install the Pit Bull. Using a few turns with a wrench will squeeze an indentation into the door's edge - the result is a pocket that will accept both 1" and 1 1/8" wide by 2 1/4" tall latches.

MMMDLT-1 Latch Forming Tool



**SCT-1 Schlage Service Tool**

Quickly service Schlage locks with this tool. Side "A" will easily remove the threaded cap from Schlage cylinders including the new "B" series with the longer cam driver. The "B" side is used to depress the cylinder cap pin and turn the tailpiece on Schlage "A" series locks so the knob retainer can be depressed, and the knob removed. This method is used when a key is not available to remove the knob.

MMSCT-1 Cap Tool-Schlage



**Safe Deposit Compact Magnum Puller**

This safe deposit nose puller is machined from bar steel for strength. Roller bearings are used between the two mating surfaces to reduce the effort required when in use, and the knurling provides for a better grip. In use, a sheet metal screw is driven into the center of the safe deposit locks keyway, tightening the puller will then pull the core out. The use of the guard key and wire or similar tool will retract the bolt.

It can pull cylinders from padlocks, automotive locks, and other types of cylinders and plugs. The CMP-101 is 5" long when closed with a 1 1/8" diameter, and is packed in a nylon pouch for storage.

MMCMP-101 Compact Nose Puller

**MDPS-4 Punch & Die Set**

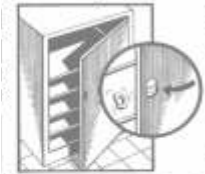

Major Manufacturing's punch and die set will punch a DOUBLE "D" hole (size .645 wide by .770 high.) in sheet metal cabinet drawers and doors. A must have for the locksmith working on vending machines, lockers, metal cabinets or any type of sheet metal door made with 18 gauge (.048) or lighter steel. Simply drill a 1/2" hole centered where the cam lock is to be installed, slide the punch through the hole and tighten down the hex nut with a 7/16" wrench or socket set. For standard cam locks.

MMMDPS-4 Double "D" Set



**MKP-1 Master Lock Keying Tool**  
Keying tool for Master Lock "UP" Series uncoded locks

1. Choose original Master padlock key to be used and remove from key ring.
2. Insert key into Master "UP" series lock.
3. Invert Padlock thru the jaws of your bench vise. Do not tighten vise.
4. Place MKP-1 keying tool over key and tap lightly with hammer until cylinder sets into lock. Remove padlock from vise and check for proper operation.

MMMKP-1 Keying Tool

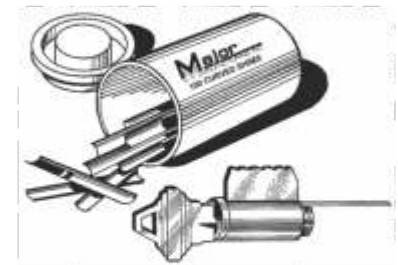

**Curved Shim Stock**

Quality Shim Stock manufactured from Hi-Grade Stainless Steel. Pre-curved to match the lock plug being shimmed.

CSS-25 25 Shims per bag  
CSS-100 100 Shims per plastic vial

MMCSS-100 Curved Shim Stock  
MMCSS-25 Curved Shim Stock



**LOCKSMITH TOOLS — continued**



**Locksmith Screw Assortment**

An assortment containing 18 of the most commonly used and misplaced screws that are required when servicing locks. The LSA-1 kit contains mortise cylinder cam screws, cylinder set screws, face plate screws and others. Also included are the allen wrenches needed for the allen screws used in the kit.

MMLSA-1 Locksmith Screw Assort.



**Oversize Repair Screw Assortment**

An assortment of specialized screws used to make quick repairs when replacing stripped out screws in wood and metal doors. The kit contains a #12 x 7/8" phillips flat tec point machine screw with a 14-24 thread. It includes a #12 x 1 3/8" Phillips flat wood screw that has a #14 body. Last is the #8 x 1/2" machine screw with a 10-32 body. Included with the 10-32 screws is a #21 drill bit and 10-32 tap to repair the damaged 8-32 hole.

MMLSA-3 Oversize Screw Assort.



**Cylinder Accessory Kit**

The CAK-15 is a new cylinder accessory kit that contains an assortment of popular hardened cylinder guards, plus cylinder collars molded from an "Engineered Plastic". Unlike steel or aluminum that can chip, scratch or bend, collars from engineered plastic will not lose their finish or shape. The kit is packed in a handy plastic box for storage and part numbers are identified.

MMCAK-15 Cylinder Accessory Kit

**DOOR HANDLING TOOLS**



**DT-200 Door Tote**

Save time, money, and accidents by moving doors with the use of our door tote. Door tote will accommodate doors up to 1 3/4". Equipped with pneumatic wheels for easy mobility and carpet lined to protect the door surface. Small but mighty will easily store in a service vehicle.

MMDT-200 Mini Door Tote

American-made, the DL-150 is built to last!



**DL-150 Door Lifter**

Removing a door from its frame has never been easier when using our new door lifter! In just a few easy steps, the door is lifted and swiveled out of the way on a ball-bearing base. The DL-150 has a textured foot pedal to prevent slipping and a cushioned base to protect the floor surface.

MMDL-150 Door Lifter

**DT-100 Door Tote**

Save time and money, and accidents by moving doors with the use of our door tote. The DT-100 door tote will accommodate doors up to 1 3/4" may also be used as a horizontal door stand. Equipped with pneumatic wheels for easy mobility, and carpet-lined to protect the door surface. Handle disassembles into three pieces for storage and transportation.



MMDT-100 DoorTote

**ACCESSORIES**



Our lock guard is designed to protect key-in-knob locks against pipe wrench and beating attacks. The base plate measures 3 1/2" square and will accommodate locks with rose diameters up to 2 1/8 inches, guard projection is 3 inches. Four 3/8" carriage bolts are supplied for mounting on doors up to 1 3/4 inch thick. Finish is an exterior silver powdercoat. Best results are obtained using a storeroom function lock.

MM250 Lock Guard



**Blockade Bar**

MMBB-100-36 36" Outswing  
MMBB-100-42 42" Outswing  
MMBB-100-72 72" Outswing



**HIT SERIES**

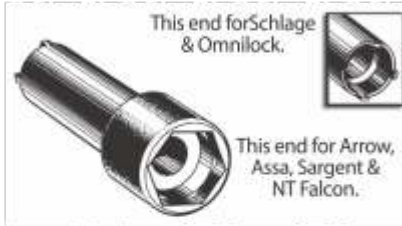

**HIT-2**

The HIT-2 is a multi-purpose nut driver for use on Schlage Rhodes, Schlage Rhodes Interchangeable Core, Assa Brooklyn, Arrow Sierra, Sargent LN, NT Falcon and Omnilock locks. The HIT-2 provides for better grip and control when tightening the spindle locking nut than does the plastic tool provided by the manufacturer, greatly decreasing installation time.

**MMHIT-2 Wrench Nut Driver**



Drill Guide For Combination Unit For Kaba Ilco 1000 / L1000 And Alarm Lock T2 / T3 / T3 Prox Pushbutton Lock

**HIT-102**

A combination unit designed for Kaba Ilco (Simplex) and Alarm Lock pushbutton locks. Quickly locates and permits drilling of all thru bolt holes including lever holes, anchor tabs, and wire run for Trilogy and combination change hole for Kaba Ilco. The HIT-102 is for use with 2 3/4" backset and 1 3/8" to 2" thick doors. Unit has bushings on both front and back plate to allow drilling from both sides of door. See compatibility chart for complete list of locks covered.

**MMHIT-102 Template**



**HIT-111**

The HIT-111 is a multipurpose jig used on both wooden or metal doors to retrofit cylindrical lever locks by Assa, Arrow, Corbin, Marks, Sargent Grade 1, Schlage, Russwin, and many more. HIT-111 is your all-around tool for ADA mandated lever handle locks.

Drill bushings on both sides of fixture to allow drilling from both sides of door. Fits 1 3/8" to 2" doors with standard 2 3/4" backset or 3 3/4" and 5" backset doors with the HITBAK. Unit has bushings on both front and back plate to allow drilling from both sides of door.

**MMHIT-111 Multipurpose Jig**

LOCK MANUFACTURER	HIT-102	HIT-111	HIT-13	HIT-15	HIT-116
COMPATIBILITY CHART FOR CYLINDRICAL PUSH BUTTON LOCKS					
Alarm Lock Trilogy T2	x				
Alarm Lock Trilogy T3	x				
Alarm Lock Trilogy T3 Prox	x				
Kaba Ilco 1000/L1000 Series	x				x
Kaba Ilco 5000 Series					x
Schlage Cobra					
COMPATIBILITY CHART FOR CYLINDRICAL LEVER LOCKS					
Arrow Sierra		x			
Assa Brooklyn		x			
Cal-Royal Grade 1					
Corbin Russwin CL3300 Series		x			
Corbin Russwin CL3900 Series		x			
IDN-Distributors Grade 2				x	
Lori 2100 Series Retro Kit		x			
Lori 2200 Series Retro Kit		x			
Lori 2250 Series Retro Kit		x			
LSDA LX Series				x	
Marks Hardware 170 Series		x			
Marks Hardware 190/195 Series		x			
Marks Hardware 195/295 Series		x			
Medeco Embassy 17 Series		x			
Medeco Embassy 19 Series		x			
NT Falcon B Series Grade 2		x			
NT Falcon T Series Grade 1		x			
Omnilock		x			
PDQ Spirit All Series		x			
S. Parker Hardware XL Series				x	
Sargent 10 Line Grade 1		x			
Sargent 6500 Series Grade 2			x		
Schlage AL Grade 2		x			
Schlage Rhodes Grade 1		x			
US Lock Grade 2 Lever				x	
Yale 5300LN Grade 2		x			
Yale 5400LN Grade 1		x			

**HIT SERIES — continued**



**HIT-45AR1**

Use this template and HIT-45 Clamp to route 1" x 6 7/8" faceplate openings used for Adams Rite locks and latches. Requires use of router equipped with 3/8" outside diameter guide and a 1/4" router bit.  
(Part # for our router bit HIT-45RB4.)

MMHIT-45AR1 Template Alum Doors

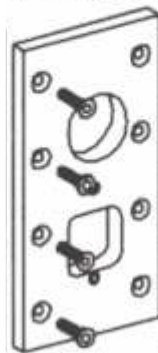

**HIT-45AR3**

For same use as HIT-45AR2 but only for locks with 3/8" or 1 1/2" backset.

MMHIT-45AR3 Template Alum Doors

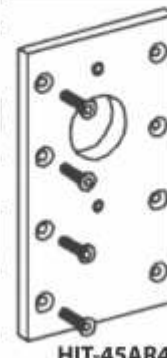

**HIT-45AR4**

Route cylinder and handle or paddle holes for Adams Rite locks and latches with a 3/8" or 1 1/2" backset. Will also locate mounting holes for handles and paddles with hardened drill bushings. Requires HIT-45 Clamp and router equipped with 3/8" outside diameter guide and 1/4" router bit.  
(Part # for our router bit HIT-45RB4.)

MMHIT-45AR4 Template Alum Doors

**HIT-41 SERIES**

The HIT-41 SERIES will allow fast and accurate installation of electric strikes in aluminum doors and frames with the use of a router. After using scribe lines on the template to determine the proper alignment, fasten template to the door or frame with the two self drilling screws (supplied) and route out the opening. After removing the HIT-41 from the frame, the mounting holes left

from the template are used to locate the strike mounting tabs supplied by the factory.

HIT-41 SERIES will work on the frame of a single offset hung door, or the inactive leaf of a double door. Requires a router with a 3/8" outside diameter guide and a 1/4" diameter router bit.



**Adams Rite 7130 & 7430 SERIES  
in an Offset Hung Frame  
HIT-41AR2**

Used to install Adams Rite 7130 & 7430 SERIES strike. The 7130 & 7430 Strike is used opposite an Adams Rite latch when replacing a MS SERIES lock. The larger 6 7/8" face of the 7130 will cover the strike opening left by the MS SERIES deadbolt. Requires a router with a 3/8" outside diameter guide and a 1/4" diameter router bit.

MMHIT-41AR2 Template-AR7130



**HES 5000 & 5700 SERIES  
in an Offset Hung Frame  
HIT-41HS2**

Same as the HIT-41HS1 but for 5000 and 5700 SERIES strikes equipped with the 503 option. Faceplate size is 1 1/4" x 6 7/8" with round corners. This strike is used when removing a deadbolt lock and replacing it with a deadlatch. The larger faceplate covers the long opening left by the dead bolt strike. Requires a router with a 3/8" outside diameter template guide and a 1/4" diameter router bit. (Part # for our router bit is HIT-45RB4.) For use on offset hung aluminum doors and frames only.

MMHIT-41HS2 HES5000/5700

**HIT SERIES — continued**

**ROUTER RECOMMENDATION**

Aluminum door templates require a router equipped with  $\frac{3}{8}$ " outside diameter guide and a  $\frac{1}{4}$ " bit. For aluminum door installation we recommend the use of a commercial router. We highly recommend a commercial router with a "D" type handle because this router can be more easily controlled and the on/off switch can be operated with your trigger finger.



**HIT-45RB4**

Special single flute  $\frac{1}{4}$ " down shear router bit used to route openings in aluminum doors and frames. NOT FOR USE ON STEEL DOORS OR FRAMES.

MMHIT-45RB4 Router Bit/Titanium



**MMHIT-21**

Drill Guide for Inside Mortise



**MMHIT-23**

Backset Re-Drill Guide



**HIT-45**  
On Aluminum  
Frame Door

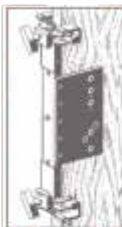

**HIT-45**  
On Wood  
Frame Door



**HIT-45**

At the center of our new installation system is the HIT-45 modular clamp. The HIT-45 Clamp will work on aluminum, wooden or hollow metal doors. HIT-45 has a grip range from  $1\frac{1}{4}$ " to over  $2\frac{1}{4}$ " without the use of special adapters or plates. Clamping pressure is positive with the HIT-45 always being self centering by design.

The use of two internal locating studs assures that backset is calculated from door center, regardless of flat, beveled or radius doors. The HIT-45 modular clamp will work with any router or drill template shown.

MMHIT-45 Clamp



**MMHIT-60**

Drill Guide for Wire Run



**MMHIT-60-134-38**  
 $\frac{3}{8}$ " Drill Block for HIT-60

**MMHIT-60-134-516**  
 $\frac{5}{16}$ " Drill Block for HIT-60



**MMHIT-60-3848**

$\frac{3}{8}$ " Carbide Tip Bit  
**MMHIT-60-51648**  
 $\frac{5}{16}$ " Carbide Tip Bit



## FULL SURFACE HINGES

### FS-101 Full Surface 1/8" Inset

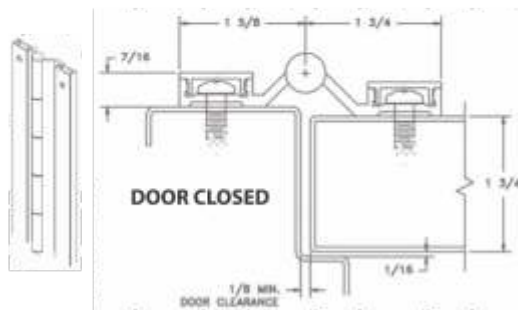

- Features:**
- Aluminum
  - Grade 2
  - No exposed mounting fasteners
  - Universal screw pack
  - Supports weights up to 600lbs.
  - 4'0" maximum door width
  - 7'0" Size
  - Brushed aluminum finish
  - 1/4" diameter Teflon-coated stainless steel pin
  - Long-life split nylon bearings

MKFS-101-83C 1/8" Alum-Alum  
MKFS-101-83D 1/8" Alum-D/Brz

### FS-102 Full Surface Flush Mount

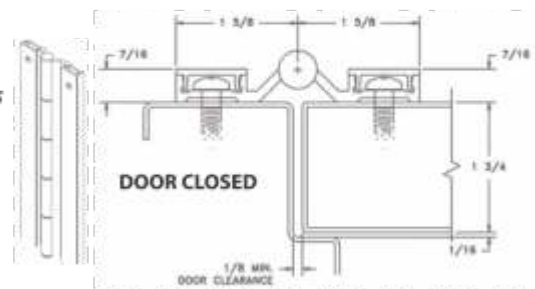

MKFS-102-83C Alum-Alum  
MKFS-102-83D Alum-D/Brz

### FS-201 Full Surface 1/8" Inset

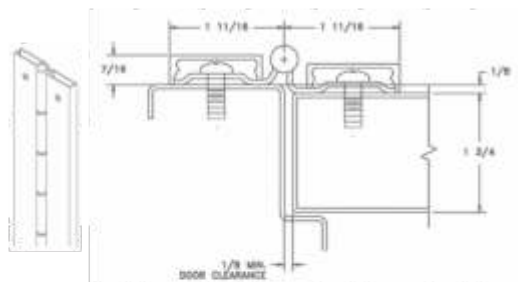

- Features:**
- Carbon steel
  - Fire Rated - 3hrs
  - Gray powder coat primer (PP)
  - Grade 2
  - No exposed mounting fasteners
  - Supports up to 600lbs
  - 4'0" maximum door width

MKFS201-83 1/8" Offset

### FS-202 Full Surface Flush Mount

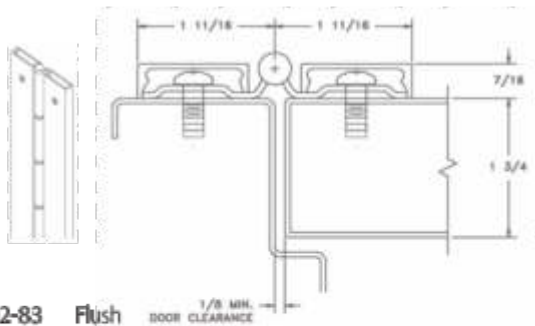

MKFS202-83 Flush

### FS-302 Full Surface Flush Mount

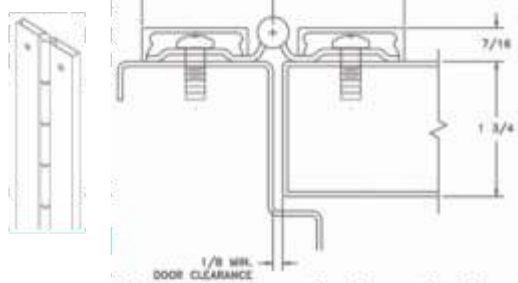

- Features:**
- Stainless steel
  - Fire Rated - 3hrs
  - Grade 1
  - Supports up to 600lbs
  - 4'0" maximum door width
  - 7'0" Size

MKFS302-83 Flush, Stainless Steel

### FS-302

For flush doors. This surface-mounted pin & barrel type continuous hinge can be used to repair both fire labeled and non-labeled doors that have very tight clearances.

## CONCEALED HINGE GUARD

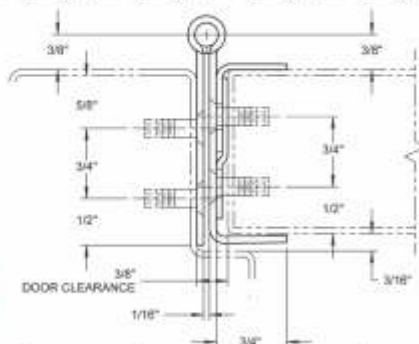

- Features:**
- Stainless steel
  - Fire Rated - 3hrs
  - Wrap around edge guard
  - Opens to 180°

MKHG305-79

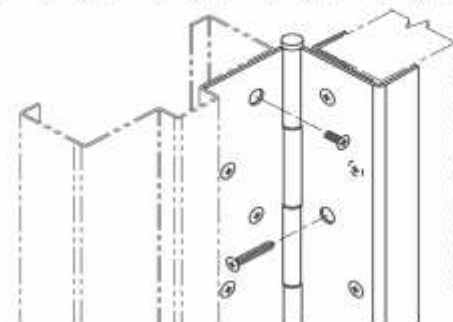



# DESIGNED WITH THE LOCKSMITH IN MIND

## Master Lock Residential Door Hardware

Top-notch quality with great features and workability combined for a professional job well done, secured with a name your customers know and trust.

- Corrosion-resistant solid brass cylinder plug is available in KW1, SC1, WR5 and WK2 keyways
- All metal chassis with no plastic or die-cast parts
- High quality, all steel, universal latch that adjusts to fit all doors

©2016 Master Lock Company LLC



Polished Brass



Satin Nickel



Antique Brass



Aged Bronze

To find out more, visit [masterlock.com/door](http://masterlock.com/door)

**Master  
Lock.**

## PADLOCKS

### Commercial Boxed Products



21 • 25 • 27

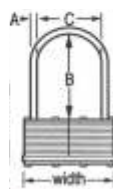

101

#### Features:

- Quickly rekeyable to meet customers' needs
- Removable cylinder can be replaced or repinned
- Hardened steel shackle (No. 21)
- Hardened boron alloy shackle (No. 25, 27, 101)
- 5-pin tumbler cylinder for added security
- Hardened steel bottom plates (No. 21, 25, 27) for extra drill resistance

#### 1 3/4" Wide Body

ML21	KD 5-Pin W27 Cylinder
ML21KA-10L500	KA 5-Pin W27 Cylinder
ML21KA-10L726	KA 5-Pin W27 Cylinder
ML21KZW1	0-Bitted 4-Pin W1 Cylinder
ML21WO	Less Cylinder
ML21KALF-10L045	KA 5-Pin W27 Cylinder
ML21KALF-10L726	KA 5-Pin W27 Cylinder
ML21KZLFW1	0-Bitted 4-Pin W1 Cylinder
ML21LFWO	Less Cylinder
ML21KALJ-10L499	KA 5-Pin W27 Cylinder
ML21KALJ-10L726	KA 5-Pin W27 Cylinder
ML21KZLJW1	0-Bitted 4-Pin W1 Cylinder
ML21KZLNW1	0-Bitted 4-Pin W1 Cylinder
ML21LJWO	Less Cylinder
ML21WCS	Lock Body Only

#### 2" Wide Body

ML25KA-10L249	KA 5-Pin W27 Cylinder
ML25KZW1	0-Bitted 4-Pin W1 Cylinder
ML25WO	Less Cylinder 3/8"
ML25LJWO	Less Cylinder 3/8"

#### 3 1/4" Wide Body

ML101	KD 5-Pin W27 Cylinder
-------	-----------------------

#### Shackle Dimensions

	A	B	C
	5/16"	15/16"	3/4"
	5/16"	15/16"	3/4"
	5/16"	15/16"	3/4"
	5/16"	15/16"	3/4"
	5/16"	1 1/2"	3/4"
	5/16"	1 1/2"	3/4"
	5/16"	1 1/2"	3/4"
	5/16"	2 1/2"	3/4"
	5/16"	2 1/2"	3/4"
	5/16"	2 1/2"	3/4"
	5/16"	5 3/4"	3/4"
	5/16"	2 1/2"	3/4"
	-	-	-
	A	B	C
	3/8"	1"	15/16"
	3/8"	1"	15/16"
	1"	15/16"	
	2 1/2"	15/16"	
	A	B	C
	5/16"	3"	2 1/4"



**PRO SERIES REKEYABLE PADLOCKS**

**Weather Tough**



6121 • 6125 • 6127

**DIMENSIONS**

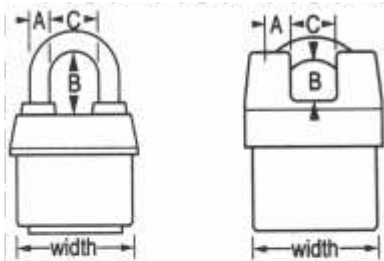

6121  
6125  
6127

6321  
6325  
6327



6121KALJ-10G122

6321KA-10G122

**High Security**



6321 • 6325 • 6327

**Features:**

- Removable cylinder can be replaced or repinned
- Hardened boron alloy shackles for superior cut resistance
- 5 spool pin tumbler cylinder for added pick resistance
- Dual ball bearing locking mechanism resists pulling and prying

**Weather Tough 2 1/4" Wide Body**

ML6121	KD 5-Pin W6000 Cylinder
ML6121D	KD 5-Pin W6000 Cylinder
ML6121KA-10G079	KA 5-Pin W6000 Cylinder
ML6121KA-10G100	KA 5-Pin W6000 Cylinder
ML6121KA-10G103	KA 5-Pin W6000 Cylinder
ML6121KA-10G105	KA 5-Pin W6000 Cylinder
ML6121KA-10G122	KA 5-Pin W6000 Cylinder
ML6121KZW1	0-Bitted 4-Pin W1 Cylinder
ML6121WO	Less Cylinder
ML6121KALJ-10G100	KA 5-Pin W6000 Cylinder
ML6121KALJ-10G103	KA 5-Pin W6000 Cylinder
ML6121KALJ-10G105	KA 5-Pin W6000 Cylinder
ML6121KALJ-10G122	
ML6121LJWO	Less Cylinder

**Shackle Dimensions**

	A	B	C
ML6121	5/16"	1 3/8"	7/8"
ML6121D	5/16"	1 3/8"	7/8" ★
ML6121KA-10G079	5/16"	1 3/8"	7/8"
ML6121KA-10G100	5/16"	1 3/8"	7/8"
ML6121KA-10G103	5/16"	1 3/8"	7/8"
ML6121KA-10G105	5/16"	1 3/8"	7/8"
ML6121KA-10G122	5/16"	1 3/8"	7/8"
ML6121KZW1	5/16"	1 3/8"	7/8"
ML6121WO	5/16"	1 3/8"	7/8"
ML6121KALJ-10G100	5/16"	2 1/2"	7/8"
ML6121KALJ-10G103	5/16"	2 1/2"	7/8"
ML6121KALJ-10G105	5/16"	2 1/2"	7/8"
ML6121KALJ-10G122	5/16"	2 3/8"	7/8"
ML6121LJWO	5/16"	2 1/2"	7/8"

**Weather Tough 2 3/8" Wide Body**

ML6125	KD 5-Pin W6000 Cylinder
ML6125KA-10G100	KA 5-Pin W6000 Cylinder
ML6125KA-10G103	KA 5-Pin W6000 Cylinder
ML6125KZW1	0-Bitted 4-Pin W1 Cylinder
ML6125WO	Less Cylinder
ML6125LJ	KD 5-Pin W6000 Cylinder
ML6125KALJ-10G100	KA 5-Pin W6000 Cylinder

	A	B	C
ML6125	3/8"	1 3/8"	7/8"
ML6125KA-10G100	3/8"	1 3/8"	7/8"
ML6125KA-10G103	3/8"	1 3/8"	7/8"
ML6125KZW1	3/8"	1 3/8"	7/8"
ML6125WO	3/8"	1 3/8"	7/8"
ML6125LJ	3/8"	2 1/2"	7/8"
ML6125KALJ-10G100	3/8"	2 1/2"	7/8"

**Weather Tough 2 5/8" Wide Body**

ML6127	KD 5-Pin W6000 Cylinder
ML6127WO	Less Cylinder
ML6271KA-400K001	PRO SERIES HIDDEN SHACKLE
ML6271W700A	PRO SERIES HIDDEN SHACKLE
ML6421WO	PRO SERIES HIDDEN SHACKLE KD

	A	B	C
ML6127	7/16"	1 3/8"	7/8"
ML6127WO	7/16"	1 3/8"	7/8"

**High Security 2 1/2" Wide Body**

ML6321D	KD 5-Pin W6000 Cylinder
ML6321KA-10G122	
ML6321KA-10G239	KA 5-Pin W6000 Cylinder
ML6321KZW1	0-Bitted 4-Pin W1 Cylinder

	A	B	C
ML6321D	5/16"	3/4"	7/8" ★
ML6321KA-10G122	5/16"		
ML6321KA-10G239	5/16"	3/4"	7/8"
ML6321KZW1	5/16"	3/4"	7/8"

**High Security 2 3/8" Wide Body**

ML6325KA-10G239	KA 5-Pin W6000 Cylinder
ML6325KZW1	0-Bitted 4-Pin W1 Cylinder

	A	B	C
ML6325KA-10G239	3/8"	3/4"	7/8"
ML6325KZW1	3/8"	3/4"	7/8"

**High Security 2 5/8" Wide Body**

ML6327WO	Less Cylinder
----------	---------------

	A	B	C
ML6327WO	7/16"	3/4"	7/8"

★ = Retail Carded

**BLUETOOTH PADLOCKS**



**ML4401DLH**  
BLUETOOTH PADLOCK OUTDOOR USE

**ML4401LHENT**  
ENTERPRISE BLUETOOTH OUTDOOR



**ML4400D**  
BLUETOOTH PADLOCK INDOOR MODEL

**ML4400ENT**  
ENTERPRISE BLUETOOTH PADLOCK

**COMMERCIAL MAGNUM PADLOCKS**



- MLM1KALFSTS-2402
- MLM1KALFSTS-2751
- MLM1KALJSTS-2402
- MLM1KALJSTS-2751
- MLM1KASTS-2402
- MLM1KASTS-2751
- MLM1LFSTS
- MLM1LJSTS
- MLM1STS
- MLM5KALFSTS-A143
- MLM5KALFSTS-A383
- MLM5KALJSTS-A143
- MLM5KALJSTS-A383
- MLM5KASTS-A143
- MLM5KASTS-A383
- MLM5LFSTS
- MLM5LJSTS
- MLM5STS

- COMMERCIAL MAGNUM 1 1/2" SHKL
- COMMERCIAL MAGNUM 1 1/2" SHKL
- COMMERCIAL MAGNUM 2 1/2" SHKL
- COMMERCIAL MAGNUM 2 1/2" SHKL
- COMMERCIAL MAGNUM 15/16" SHKL
- COMMERCIAL MAGNUM 15/16" SHKL
- COMMERCIAL MAGNUM 1 1/2" SHKL
- COMMERCIAL MAGNUM 2 1/2" SHKL
- COMMERCIAL MAGNUM 15/16" SHKL
- COMMERCIAL MAGNUM 1 1/2" SHKL
- COMMERCIAL MAGNUM 1 1/2" SHKL
- COMMERCIAL MAGNUM 2 1/2" SHKL
- COMMERCIAL MAGNUM 2 1/2" SHKL
- COMMERCIAL MAGNUM 1" SHKL
- COMMERCIAL MAGNUM 1" SHKL
- COMMERCIAL MAGNUM 1 1/2" SHKL
- COMMERCIAL MAGNUM 2 1/2" SHKL
- COMMERCIAL MAGNUM 1" SHKL

**PRO SERIES REKEYABLE PADLOCKS**



6230

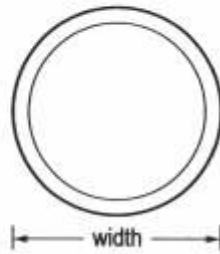

No. 6271

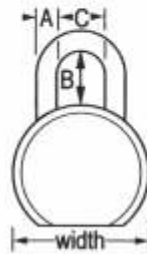

No. 6230

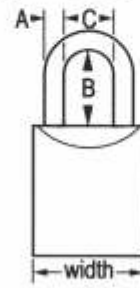

Nos. 7030,  
7040, 7050

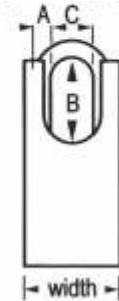

Nos. 7035  
and 7045



6271

**Solid Steel 2 1/2" Wide Body**

		Shackle Dimensions		
		A	B	C
ML6230D	KD 5-Pin W6000 Cylinder	7/16"	1 1/8"	7/8" ★
ML6230KA-10G100	KA 5-Pin W6000 Cylinder	7/16"	1 1/8"	7/8"
ML6230DLH	KD 5-Pin W6000 Cylinder	7/16"	2"	7/8" ★
ML6271	KD 6-Pin W7000 Cylinder	3/8"	NA	NA

( ML6271 width 2 7/8" - Die Cast Body Boron Shackle )

**Solid Steel 1 1/8" Wide Body**

		A	B	C
ML7030KA-10G103	KA 5-Pin W6000 Cylinder	1/4"	1 1/8"	25/32"
ML7030WO	Less Cylinder	1/4"	1 1/8"	25/32"

**Solid Steel 1 1/8" Wide Body, Shrouded Shackle**

		A	B	C
ML7035KA-10G103	KA 5-Pin W6000 Cylinder	1/4"	1 1/8"	25/32"

**Solid Steel 1 3/4" Wide Body**

		A	B	C
ML7040D	KD 5-Pin W6000 Cylinder	5/16"	1 3/8"	29/32" ★
ML7040KALJ-10G103	KA 5-Pin W6000 Cylinder	5/16"	2 1/2"	29/32"

**Solid Steel 1 3/4" Wide Body, Shrouded Shackle**

		A	B	C
ML7045KA-10G103	KA 5-Pin W6000 Cylinder	5/16"	1 3/8"	29/32"
ML7045WO	Less Cylinder	5/16"	1 3/8"	29/32"

**Solid Steel 2" Wide Body**

		A	B	C
ML7050WO	Less Cylinder	3/8"	1 1/2"	29/32"

**Hidden Shackle, Solid Steel 2 7/8" Wide Body**

		A	B	C
ML6270KA-400K001	KA 6-Pin W7000 Cylinder	3/8"	NA	NA

★ = Retail Carded



7030, 7040, 7050



7035, 7045



## PRO SERIES REKEYABLE PADLOCKS

### Features:

- Solid Brass
- Corrosion resistant solid brass body for caustic, corrosive, salty environments
- Hardened steel shackle for extra cut resistance
- Removable cylinder can be replaced or repinned
- 5 spool pin tumbler cylinder for added pick resistance
- Solid brass bodies & cylinders provide excellent corrosion resistance
- Aluminum
- Brightly colored locks for easy identification
- Hardened steel shackle for extra cut resistance
- Removable cylinder can be replaced or repinned
- 5 spool pin tumbler cylinder for added pick resistance
- Powder-coated finish lasts longer than anodized

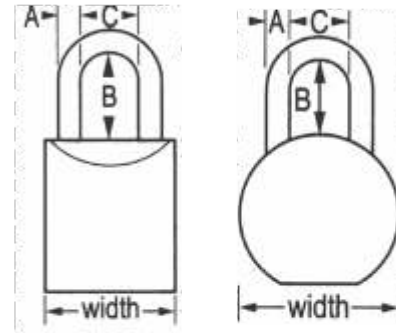

### 1 3/4" Wide Solid Brass Body A

		Shackle Dimensions		
		B	C	
ML6840D	KD 5-Pin W6000 Cylinder	5/16"	1 3/16"	29/32" ★
ML6840KZW1	0-Bitted 4-Pin W1 Cylinder	5/16"	1 3/16"	29/32"
ML6840WO	Less Cylinder	5/16"	1 3/16"	29/32"

### 2" Wide Solid Brass Body

		A	B	C
ML6850KZW1	0-Bitted 4-Pin W1 Cylinder	3/8"	1 1/2"	29/32"

### 1 9/16" Wide Aluminum Body A

		B	C	
ML6835BLU	KD 5-Pin W6000 Cylinder	1/4"	1 1/16"	25/32" Blue
ML6835KARED-10G040	KA 5-Pin W6000 Cylinder	1/4"	1 1/16"	25/32" Red

★ = Retail Carded



### Die-Cast Zinc and Solid Steel Padlocks

#### Features:

- Solid brass lock body is stylish and strong
- Brass, standard steel, and hardened steel shackles available
- 3-pin cylinders

### 2 1/2" Wide

		Shackle Dimensions		
		A	B	C
ML230KA-10L033	Keyed Alike	7/16"	1"	15/16"

## PRO SERIES INTERCHANGEABLE CORE PADLOCKS

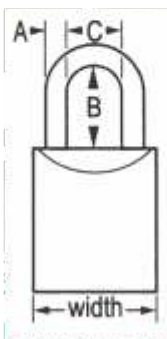

### Weather Tough • Less Core

		Shackle Dimensions		
		A	B	C
ML6421WO	2 1/8" Wide Body	5/16"	1 1/8"	7/8"



### Solid Brass • Less Core

		A	B	C
ML6851WO	2" Wide Body	3/8"	1 1/2"	29/32"

**PRO SERIES DOOR KEY COMPATIBLE PADLOCKS**



6621 • 6627  
Weather Tough



6721 • 6727  
High Security



7042  
Solid Steel



6842 • 6852  
Solid Brass

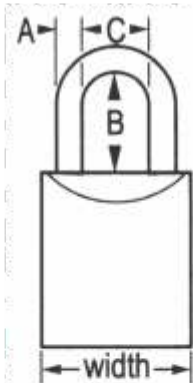

**Weather Tough • Less Core**

- ML6621WO 2 1/8" Wide Body
- ML6627WO 2 5/8" Wide Body

**High Security • Less Core**

- ML6721WO 2 1/8" Wide Body
- ML6727WO 2 5/8" Wide Body

**Solid Steel • Less Core**

- ML7042WO 1 3/4" Wide Body

**Solid Brass**

- ML6842D045KZ 1 3/4" Wide Body
- ML6852WO 2" Wide Body

*Shackle Dimensions*

	A	B	C	
Weather Tough • Less Core				
ML6621WO	5/16"	1 1/8"	7/8"	
ML6627WO	7/16"	1 3/8"	7/8"	
High Security • Less Core				
ML6721WO	5/16"	3/4"	7/8"	
ML6727WO	7/16"	3/4"	7/8"	
Solid Steel • Less Core				
ML7042WO	5/16"	1 3/16"	29/32"	
Solid Brass				
ML6842D045KZ	5/16"	1 3/16"	25/32"	Keyed SC1
ML6852WO	3/8"	1 1/2"	29/32"	Less Core

**PADLOCKS**

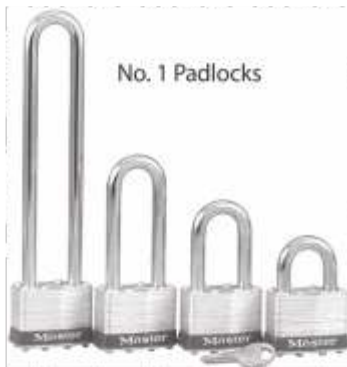

No. 1 Padlocks

**Retail Carded Products & Commercial Boxed Products**

*Features:*

- 1 3/8" wide laminated steel body for superior strength
- Hardened steel shackle for extra cut resistance
- 4-pin cylinder helps prevent picking
- Dual locking levers provide extra pry resistance
- Proprietary rustproofing for longer life
- Hardened bottom plate for drill resistance
- Top & bottom bumpers for greater scratch resistance

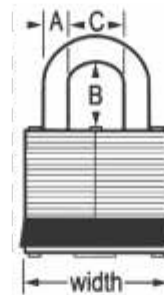

*Shackle Dimensions*

**1KA Stock Key Numbers**

- X2137 X2174 2017 2032 2035
- 2194 2396 2402 2589 2645
- 2729 2732 2751 3476

**1KALF Stock Key Numbers**

- 2402 2578 2589 2732 2736
- 2751

**1KALJ Stock Key Numbers**

- 2396 2402 2589 2732 2736
- 2751

**1KALN Stock Key Numbers**

- 2194 2736 2751

**Product Number**

- ML1D KD Retail Carded Product
- ML1 KD Commercial Boxed Product
- ML1KA KA Commercial Boxed Product
- ML1KALF KA Commercial Boxed Product
- ML1KAWP4-2034EL KA Commercial Boxed Product
- ML1DLJ KD Retail Carded Product
- ML1KALJ KA Commercial Boxed Product
- ML1KALN KA Commercial Boxed Product
- ML1KAWP4-2034EL KA Edge Patent Keyway

**Description**

	A	B	C
ML1D	5/16"	1 3/16"	3/4"
ML1	5/16"	1 3/16"	3/4"
ML1KA	5/16"	1 3/16"	3/4"
ML1KALF	5/16"	1 1/2"	3/4"
ML1KAWP4-2034EL	5/16"	1 1/2"	3/4"
ML1DLJ	5/16"	2 1/2"	3/4"
ML1KALJ	5/16"	2 1/2"	3/4"
ML1KALN	5/16"	5 3/4"	3/4"
ML1KAWP4-2034EL	5/16"	5/16"	3/4"

## PADLOCKS — continued



No. 2 Padlocks

Product #	Description	A & B	C
ML2KA-3753	KA Commercial Boxed Product	5/16"	3/4"
ML2KA-2729	KA Commercial Boxed Product	5/16"	15/16"

Shackle Dimensions

A & B	C
5/16"	3/4"
5/16"	15/16"

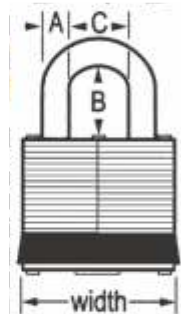

No. 3 Padlocks

### Retail Carded Products & Commercial Boxed Products

**Features:**

- 1 1/8" wide laminated steel body for superior strength
- Hardened steel shackle for extra cut resistance
- 4-pin cylinder helps prevent picking
- Dual locking levers provide extra pry resistance

**Product Number**

ML3KD  
ML3KA  
ML3KA-0793  
ML3KALF  
ML3KALF-3365  
ML3DLH  
ML3KALH  
ML3KALH-3997  
ML3MK-DD  
ML3008D  
ML3T  
MLK1-DD

**Description**

Commercial Boxed Product  
KA Commercial Boxed Product  
KA Commercial Boxed Product  
KA Commercial Boxed Product  
Padlock  
KD Retail Carded Product  
KA Commercial Boxed Product  
Boxed Product  
Master Keyed  
KA 4-Pack of #3  
2-Pack of No. 3 Keyed Alike - Retail Carded Product  
CUT MK FOR 3MK SYSTEM DD

Shackle Dimensions

A	B	C
9/32"	3/4"	5/8"
9/32"	3/4"	5/8"
9/32"	3/4"	5/8"
9/32"	1 1/2"	5/8"
9/32"	1 1/2"	5/8"
9/32"	2"	5/8"
9/32"	2"	5/8"
9/32"	2"	5/8"
9/32"	3/4"	5/8"

**3KA Stock Key Numbers**

0356	0396	0464	0536	3223
3225	3303	3336	3361	3365
3507	3554	3576	3753	3826
3858	3986	3997		

**3KALF Stock Key Numbers**

0396	0464	0536	3303	3336
3507	3576	3753	3858	3997

**3KALH Stock Key Numbers**

0396	0464	0536	3303	3336
3507	3576	3753	3858	

No. 4 Padlocks



### Retail Carded Products & Commercial Boxed Products

**Features:**

- 1 1/8" wide laminated steel body for superior strength
- Hardened steel shackle for extra cut resistance

- 4-pin cylinder helps prevent picking
- Dual locking levers
- Ideal for harsh environments

**Product Number**

ML4KA-3753

**Description**

KA Commercial Boxed Product

Shackle Dimensions

A	B	C
9/32"	3/4"	5/8"

No. 5 Padlocks



### Retail Carded Products & Commercial Boxed Products

- 2" wide laminated steel body for superior strength
- Hardened boron alloy shackle for superior cut resistance
- 4-pin cylinder helps prevent picking
- Dual locking levers provide extra pry resistance
- Proprietary rustproofing for longer life
- Hardened bottom plate for drill resistance
- Top & bottom bumpers for greater scratch resistance

**5KA Stock Key Numbers**

A101	A143	A301	A382
A383	A389	A432	A433
A812			

**5KALF Stock Key Numbers**

A143	A383
------	------

**5KALJ Stock Key Numbers**

A101	A112	A143
------	------	------

**Product Number**

ML5KA  
ML5KALF  
ML5KALF-A101  
ML5KALF-A382  
ML5KALJ  
ML5KALJ-A383  
ML5T  
ML5DCOM

**Description**

KA Commercial Boxed Product  
KA Commercial Boxed Product  
KA Commercial Boxed Product  
KA Commercial Boxed Product  
KA Commercial Boxed Product  
Carded  
KA 2-Pack of #5  
Carded

Shackle Dimensions

A	B	C
3/8"	1"	15/16"
3/8"	1 1/2"	15/16"
3/8"	1 1/2"	15/16"
3/8"	1 1/2"	15/16"
3/8"	2 1/2"	15/16"
3/8"	1"	15/16"
3/8"	1"	15/16"
3/8"	1"	15/16"



**PADLOCKS — continued**

**No. 7 Padlocks**



**Retail Carded Products & Commercial Boxed Products**

**Features:**

- 1 1/8" wide laminated steel body for superior strength
- Standard steel shackle
- 4-pin cylinder helps prevent picking
- Minimal clearance helps prevent prying
- Proprietary rustproofing for longer life

**7KA Stock Key Numbers**

P115 P163 P221 P287  
P328 P377 P407 P563  
P611 P631 P706 P812

**7KALF Stock Key Numbers**

P706

**7KALJ Stock Key Numbers**

P706

Product #	Description
ML7D	KD Retail Carded Product
ML7	KD Commercial Boxed Product
ML7KA	KA Commercial Boxed Product
ML7KALF	KA Commercial Boxed Product
ML7KALJ	KA Commercial Boxed Product

Shackle Dimensions		
A	B	C
3/16"	9/16"	1/2"
3/16"	9/16"	1/2"
3/16"	9/16"	1/2"
3/16"	1 1/2"	1/2"
3/16"	2 1/2"	1/2"

**No. 10 Padlocks**



Product #	1" Wide, Laminated Steel Body
ML10KA-L23	KA Commercial Boxed Product

Shackle Dimensions		
A	B	C
5/32"	7/16"	13/32"

**No. 22 Padlocks**



Product #	1 1/2" Wide, Laminated Steel Body
ML22KA-337	KA Commercial Boxed Product
ML22KA-280	Padlock - 1/4" x 5/8" SHKL WM

Shackle Dimensions		
A	B	C
1/4"	5/8"	9/16"

**22KA Stock Key Numbers**  
337

**No. 37 Padlocks**



Product #	Description
ML37D	KD Retail Carded Product



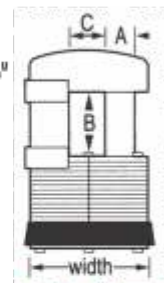

**Features:**

- Armored hardened steel shackle defies cutting
- 1 1/8" laminated steel body for superior strength
- 4-pin tumbler cylinder helps prevent picking
- Shackle guard protects against bolt cutters and hacksaw
- Ideal for securing trailers, cables and chains

Shackle Dimensions		
A	B	C
N/A	15/16"	7/16"

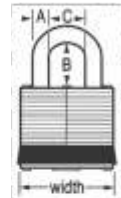

## PADLOCKS — continued

	<p><b>No. 105 Padlocks</b></p> <p><b>Product #</b> ML105KA-041</p> <p><b>1 3/8" Wide, Laminated Steel Body</b> KA Commercial Boxed Product</p>	<p><i>Shackle Dimensions</i></p> <table border="1"> <thead> <tr> <th>A</th> <th>B</th> <th>C</th> </tr> </thead> <tbody> <tr> <td>3/16"</td> <td>1/2"</td> <td>1/2"</td> </tr> </tbody> </table>	A	B	C	3/16"	1/2"	1/2"																														
A	B	C																																				
3/16"	1/2"	1/2"																																				
	<p><b>No. 500 Padlocks</b></p> <p><b>Product #</b> ML500KA-370 ML500KABRK-197</p> <p><b>1 3/4" Wide, Laminated Steel Body</b> KA Commercial Boxed Product KA Breakaway Shackle</p>	<p><i>Shackle Dimensions</i></p> <table border="1"> <thead> <tr> <th>A</th> <th>B</th> <th>C</th> </tr> </thead> <tbody> <tr> <td>9/32"</td> <td>13/16"</td> <td>13/16"</td> </tr> <tr> <td>9/32"</td> <td>13/16"</td> <td>13/16"</td> </tr> </tbody> </table>	A	B	C	9/32"	13/16"	13/16"	9/32"	13/16"	13/16"																											
A	B	C																																				
9/32"	13/16"	13/16"																																				
9/32"	13/16"	13/16"																																				
	<p><b>Product #</b> ML510D ML517D</p> <p><b>1 3/4" Wide, Laminated Steel Body</b> KD Retail Carded Product KD Retail Carded Product</p>	<p><i>Adj. Shackle Dimensions</i></p> <table border="1"> <thead> <tr> <th>A</th> <th>B</th> <th>C</th> </tr> </thead> <tbody> <tr> <td>9/32"</td> <td>5/8" - 2"</td> <td>13/16"</td> </tr> <tr> <td>9/32"</td> <td>2 3/4" - 5 3/8"</td> <td>13/16"</td> </tr> </tbody> </table>	A	B	C	9/32"	5/8" - 2"	13/16"	9/32"	2 3/4" - 5 3/8"	13/16"																											
A	B	C																																				
9/32"	5/8" - 2"	13/16"																																				
9/32"	2 3/4" - 5 3/8"	13/16"																																				
	<p><b>Universal Pin Series Padlocks</b></p> <table border="1"> <thead> <tr> <th>Product #</th> <th>Description</th> </tr> </thead> <tbody> <tr> <td>ML1UP</td> <td>Commercial Boxed Product</td> </tr> <tr> <td>ML1UPLJ</td> <td>Commercial Boxed Product</td> </tr> <tr> <td>ML3UP</td> <td>Commercial Boxed Product</td> </tr> <tr> <td>ML3UPLF</td> <td>Commercial Boxed Product</td> </tr> <tr> <td>ML5UP</td> <td>Commercial Boxed Product</td> </tr> <tr> <td>ML5UPLF</td> <td>Commercial Boxed Product</td> </tr> </tbody> </table>	Product #	Description	ML1UP	Commercial Boxed Product	ML1UPLJ	Commercial Boxed Product	ML3UP	Commercial Boxed Product	ML3UPLF	Commercial Boxed Product	ML5UP	Commercial Boxed Product	ML5UPLF	Commercial Boxed Product	<p><i>Shackle Dimensions</i></p> <table border="1"> <thead> <tr> <th>A</th> <th>B</th> <th>C</th> </tr> </thead> <tbody> <tr> <td>5/16"</td> <td>15/16"</td> <td>3/4"</td> </tr> <tr> <td>5/16"</td> <td>2 1/2"</td> <td>3/4"</td> </tr> <tr> <td>9/32"</td> <td>3/4"</td> <td>5/8"</td> </tr> <tr> <td>9/32"</td> <td>1 1/2"</td> <td>5/8"</td> </tr> <tr> <td>3/8"</td> <td>1"</td> <td>15/16"</td> </tr> <tr> <td>3/8"</td> <td>1 1/2"</td> <td>15/16"</td> </tr> </tbody> </table>	A	B	C	5/16"	15/16"	3/4"	5/16"	2 1/2"	3/4"	9/32"	3/4"	5/8"	9/32"	1 1/2"	5/8"	3/8"	1"	15/16"	3/8"	1 1/2"	15/16"	
Product #	Description																																					
ML1UP	Commercial Boxed Product																																					
ML1UPLJ	Commercial Boxed Product																																					
ML3UP	Commercial Boxed Product																																					
ML3UPLF	Commercial Boxed Product																																					
ML5UP	Commercial Boxed Product																																					
ML5UPLF	Commercial Boxed Product																																					
A	B	C																																				
5/16"	15/16"	3/4"																																				
5/16"	2 1/2"	3/4"																																				
9/32"	3/4"	5/8"																																				
9/32"	1 1/2"	5/8"																																				
3/8"	1"	15/16"																																				
3/8"	1 1/2"	15/16"																																				

- Features:**
- Universal Pin padlocks
  - Laminated steel body
  - 4-pin tumbler cylinders
  - Thousands of key changes maximize key integrity
  - Proprietary rustproofing
  - Dual locking levers

## SOLID BRASS PRODUCTS

	<p><b>Features:</b></p> <ul style="list-style-type: none"> <li>• Solid brass lock body is stylish and strong</li> <li>• Brass, standard steel, and hardened steel shackles available</li> <li>• 3-pin, 4-pin, and 5-pin cylinders available</li> </ul>	<p><i>Shackle Dimensions</i></p>																
	<p><b>3/4" Wide Solid Body, Standard Steel Shackle, 3-pin</b> <b>No. 120</b></p> <table border="1"> <thead> <tr> <th>Product #</th> <th>Description</th> <th>A</th> <th>B</th> <th>C</th> </tr> </thead> <tbody> <tr> <td>ML120D</td> <td>KD Retail Carded Product</td> <td>5/32"</td> <td>7/16"</td> <td>3/8"</td> </tr> <tr> <td>ML120KAD-1A38</td> <td>KA Retail Carded Product</td> <td>5/32"</td> <td>7/16"</td> <td>3/8"</td> </tr> </tbody> </table>	Product #	Description	A	B	C	ML120D	KD Retail Carded Product	5/32"	7/16"	3/8"	ML120KAD-1A38	KA Retail Carded Product	5/32"	7/16"	3/8"		
Product #	Description	A	B	C														
ML120D	KD Retail Carded Product	5/32"	7/16"	3/8"														
ML120KAD-1A38	KA Retail Carded Product	5/32"	7/16"	3/8"														
	<p><b>1 3/8" Wide Solid Body, Hardened Steel Shackle, 4-pin</b> <b>No. 130</b></p> <table border="1"> <thead> <tr> <th>Product #</th> <th>Description</th> <th>A</th> <th>B</th> <th>C</th> </tr> </thead> <tbody> <tr> <td>ML130D</td> <td>KD Retail Carded Product</td> <td>3/16"</td> <td>5/8"</td> <td>9/16"</td> </tr> <tr> <td>ML130KAD-1B046</td> <td>KD Retail Carded Product</td> <td>3/16"</td> <td>5/8"</td> <td>9/16"</td> </tr> </tbody> </table>	Product #	Description	A	B	C	ML130D	KD Retail Carded Product	3/16"	5/8"	9/16"	ML130KAD-1B046	KD Retail Carded Product	3/16"	5/8"	9/16"		
Product #	Description	A	B	C														
ML130D	KD Retail Carded Product	3/16"	5/8"	9/16"														
ML130KAD-1B046	KD Retail Carded Product	3/16"	5/8"	9/16"														
	<p><b>1 3/8" Wide Solid Body, Hardened Steel Shackle, 4-pin</b> <b>No. 140</b></p> <table border="1"> <thead> <tr> <th>Product #</th> <th>Description</th> <th>A</th> <th>B</th> <th>C</th> </tr> </thead> <tbody> <tr> <td>ML140D</td> <td>KD Retail Carded Product</td> <td>1/4"</td> <td>7/8"</td> <td>13/16"</td> </tr> <tr> <td>ML140KAD-1G003</td> <td>KA Retail Carded Product</td> <td>1/4"</td> <td>7/8"</td> <td>13/16"</td> </tr> </tbody> </table>	Product #	Description	A	B	C	ML140D	KD Retail Carded Product	1/4"	7/8"	13/16"	ML140KAD-1G003	KA Retail Carded Product	1/4"	7/8"	13/16"		
Product #	Description	A	B	C														
ML140D	KD Retail Carded Product	1/4"	7/8"	13/16"														
ML140KAD-1G003	KA Retail Carded Product	1/4"	7/8"	13/16"														
	<p><b>2" Wide Solid Body, Hardened Steel Shackle, 5-pin</b> <b>No. 150</b></p> <table border="1"> <thead> <tr> <th>Product #</th> <th>Description</th> <th>A</th> <th>B</th> <th>C</th> </tr> </thead> <tbody> <tr> <td>ML150D</td> <td>KD Retail Carded Product</td> <td>9/32"</td> <td>1"</td> <td>1"</td> </tr> </tbody> </table>	Product #	Description	A	B	C	ML150D	KD Retail Carded Product	9/32"	1"	1"							
Product #	Description	A	B	C														
ML150D	KD Retail Carded Product	9/32"	1"	1"														

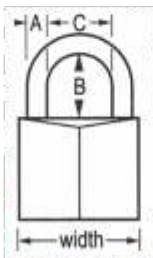

## GUN & MOTOR PADLOCKS



**Gun Locks**  
Keyed Alike,  
Series Packaging  
ML90KADSPT-P104

- Features:**
- The world standard in trigger lock design
  - Steel and zinc body for maximum durability
  - Durable metal construction
  - Protective rubber pads shield gun from scratching or marring
  - Fits many handguns, rifles and shotguns



**Set Your Own  
Combination**  
ML94DSPT

- Features:**
- Easy to attach lock™ trigger access is blocked until lock is removed
  - Features positive locking with adjustable ratchet mechanism
  - Offers added convenience of a keyless resettable combination
  - Special cushion pads protect gun's finish from marring or scratching
  - Fits most handguns, rifles and shotguns

## COMBINATION PADLOCKS



No. 175 and 178

- Features:**
- 2" wide solid brass case for strength and weatherability
  - Hardened steel and brass shackles available
  - Set-your-own combination convenience
  - Resettable to allow for a personalized combination
  - No. 177 shrouded shackle provides maximum cut resistance
  - 4-digit dialing allows for thousands of possible combinations
  - Change key included

Product #	Set Your Own Combination
ML175D	KD Retail Carded Product
ML175DLH	KD Retail Carded Product
ML175DCOM	Padlock Digital Combo 2"
ML178D	KD Die Cast Black 5/16"

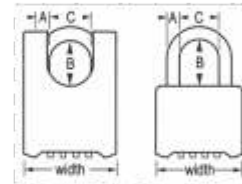

Shackle Dimensions

A	B	C
5/16"	1"	1"
5/16"	2 1/4"	1"
1"	1"	

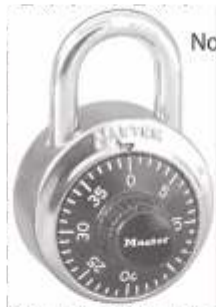

No. 1500

- Features:**
- 1 7/8" wide double-armored stainless steel body
  - World's best selling combination lock
  - Hardened steel shackle for extra cut resistance
  - Combination security for keyless convenience
  - 3-digit dialing and 1,500 combinations for maximum security

Product #	Description
ML1500	KD Commercial Boxed Product
ML1500D	KD Retail Carded Product
ML1500KA-904229	KA Commercial Boxed Product
ML1500KA-904867	KA Commercial Boxed Product

**1500KA Stock  
Combination Codes**  
904229  
904867

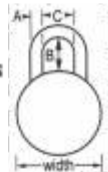

Shackle Dimensions

A	B	C
9/32"	3/4"	13/16"
9/32"	3/4"	13/16"
9/32"	3/4"	13/16"



No. 2001

- Features:**
- 2 3/8" wide double-armored stainless steel body
  - Hardened boron alloy shackle for superior cut resistance
  - 3 times stronger than No. 1500
  - 3-digit dialing and 1,500 combinations for maximum security
  - Easy-to-read black dial

Product Number	Description
ML2001	KD Commercial Boxed Product

Shackle Dimensions

A	B	C
5/16"	1"	15/16"



## COMBINATION PADLOCKS — *continued*

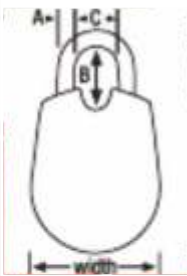

### Speed Dial Resettable Combination Locks

**Features:**

- World's first combination lock that opens on up/down/left/right directional movements
- Patented technology is faster, easier and more secure than a standard combination lock
- Maximum security with anti-shim technology
- Combination can be reset to any number of movements in any sequence
- 2" wide metal body can be opened one-handed without looking for ease of use
- Matching passcode indicators (letters, numbers, colors, shapes, symbols) are included for added customization – simply apply over arrows
- Hardened steel shackle for increased bolt cutter protection

*Shackle Dimensions*

Product Number	Set Your Own Combination	A	B	C
ML1500ID	Retail Carded Product	1/4"	1"	3/4"

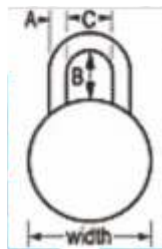

### Resettable Combination Locks

**Features:**

- Set-your-own combination using 3 letters, numbers or a mix of both
- Patented technology operates with familiar right-left-right combination lock movement
- Combination is easy to change with reset tool included in the package
- Maximum security with anti-shim technology
- 1 3/8" (49mm) wide metal body with hardened steel shackle
- High precision dial "clicks" for accurate dialing

*Shackle Dimensions*

Product Number	Set Your Own Combination	A	B	C
ML1590D	Retail Carded Product	1/4"	7/8"	13/16"



### Pro Series Resettable Combination Locks

**Features:**

- ProSeries® locks are designed for Commercial/Industrial applications
- Set-your-own 4-digit combination; 10,000 possible combinations
- No reset tool required
- Large ergonomic dials with exclusive blind feature permit operation with gloves, in low light or complete darkness
- Deadlocking mechanism protects against prying, shimming and rap attacks
- Shackle seal and dial dust cover protect internal components and dials for trouble-free operation
- 2 1/4" (57mm) wide stainless steel body for extreme corrosion resistance
- 1 1/8" (28mm) stainless steel shackle for additional corrosion resistance

ML1174D	Stainless Steel Body & Shackle
ML1175D	Brass Body & Boron Shackle
ML1175DLH	Brass Body & Boron Shackle
ML1175LHSS	Brass Body & Stainless Steel Shackle
ML1177D	Brass Body & Boron Shackle
ML1178D	Die Cast Body & Boron Shackle
ML878	Black Zinc
ML878DCOM	Black Zinc/Carded

**COMPONENTS & PARTS**

**CYLINDERS**

**No. 294 & 295 Cylinders**

- Compatible with No. 21, 24, 25, 27, 100, 220, and 230 locks
- Two keys included with each cylinder, except **Edge** cylinders
- 4-pin cylinder includes special plug extension

ML294KZW1	4-Pin W1 Cylinder • 0-Bitted
ML294UNWP4-EL	4-Pin Uncoded
ML294UNWP4-FB	4-Pin Uncoded
ML295KZW15	5-Pin W15 Cylinder • 0-Bitted
ML295KZW17	5-Pin W17 Cylinder • 0-Bitted
ML295W27	5-Pin W27 Cylinder • KD
ML295KZW27	5-Pin W27 Cylinder • 0-Bitted
ML295KZW81	5-Pin W81 Cylinder • 0-Bitted

**No. 296 PRO Series Cylinders**

- Compatible with the standard rekeyable Pro Series padlocks: No. 6121, 6125, 6127, 6230, 6321, 6325, 6327, 6830, 6835, 6840, 6850, 7030, 7035, 7040, 7045, and 7050 padlocks

- Two keys included with each cylinder, except **Edge** cylinders

ML296UNWP4-EL	4-Pin Uncoded
ML296UNWP4-FB	4-Pin Uncoded
ML296UNWP6-EL	6-Pin Uncoded
ML296UNWP6-FB	6-Pin Uncoded
ML296KZW1	4-Pin W1 Cyl. 0-Bitted
ML296KZW27	5-Pin W27 Cyl. 0-Bitted
ML296KZW6000	5-Pin W6000 OB Cyl., Rekeyable

**CYLINDER PINS**

**Cylinder Pins - Regular**

ML0001-0360	#0 Black
ML0001-0361	#1 Violet
ML0001-0362	#2 Red
ML0001-0363	#3 Blue
ML0001-0364	#4 Yellow
ML0001-0365	#5 Green
ML0001-0366	#6 Brown
ML0001-0367	#7 Black

**Cylinder Pins - Master**

ML0001-0391	#1 Violet
ML0001-0392	#2 Red
ML0001-0393	#3 Blue
ML0001-0394	#4 Yellow
ML0001-0395	#5 Green
ML0001-0396	#6 Brown
ML0001-0397	#7 Black

**Patent Cylinder Ball Bear**

ML0296-0200 200/Pkg for American Edge ML293LJS6125

**Cylinder Retaining Trap Doors**

ML21-0372 For No. 21 lock bodies

**DRIVERS & PLUGS**

**No. 298 Drivers and Plugs**

- ML0298-0627  
For Medeco Cylinder #20W200 6-Pin cylinder for "A" Series knob sets
- ML0298-0628  
For Schlage 6-pin cylinder for "A" series knob sets and 1599 Kaba Ilico Cylinders
- ML0298-0629  
Replacement Retainer Plug

**REKEYING PARTS**

**Locking Nuts**

ML21-0373 For No. 21 and 101 lock bodies

**Driver Pins, Tumbler Springs and Retainer Screws**

- ML0001-0368 Driver Pins (regular)
- ML0001-0369 Tumbler Springs
- ML21-0305 Retainer Screw for No. 21, 24, and 101
- ML0027-0334 Plug Extension to fit 4-pin W1 cylinders In No. 21, 24, 25 and 27 lock bodies

**Rekey Kit**

ML291 Rekey Kit



**SHACKLES**

**No. 292 Shackles**

For No. 21 and 24 Padlocks (Note: Shackle springs included)

ML292S21	Standard 15/16"
ML292LFS21	Extra Length 1 1/2"
ML292LJS21	Extra Length 2 1/2"
ML292LNS21	Extra Length 5 3/4"

**No. 293 Shackles**

(For No. 6121, 6124, 6621, 6840, 6841, 6842, 7040, 7041, 7042)

ML293S6121	Standard Length 1 1/8"
ML293LJS6121	Extra Length 2 3/8"
ML293LNS6121	Extra Length 5 5/8"

( For No. 6125, 6850, 6851, 6852, 7050, 7051, 7052)

	Extra Length 2 3/8" (For No. 6127, 6427, 6627)
ML293LJS6127	Extra Length 2 3/8"

**KEY BLANKS**

MLK105BOX	Key Blank
MLK120BOX	Key Blank
MLK130BOX	Key Blank
MLK150BOX	Key Blank
MLK15BOX	Key Blank
MLK1718BOX	Key Blank
MLK175BAG	Combination Change Key
MLK17BOX	Key Blank
MLK185BOX	Key Blank For No.185
MLK187BOX	Key Blank For No.187
MLK1BOX	Key Blank
MLK22LBOX	Key Blank
MLK22RBOX	Key Blank
MLK27BOX	Key Blank
MLK2BOX	Key Blank
MLK500LBOX	Key Blank
MLK500RBOX	Key Blank
MLK510BOX	Key Blank
MLK6000BOX	Key Blank 6000B
MLK7000BOX	Key Blank W7000 6-Pin
MLK7BOX	Key Blank 7K Master
MLK8109BOX	Key Blank
MLK8154BOX	Key Blank For #8154 Locks
MLK81BOX	Key Blank (Stamped 81)
MLK81KMBOX	Key Blank (Stamped M)
MLKWP4BOX-1014EL	EI Patent Key Blank 4-Pin
MLKWP6BOX-1014EL	EI Patent Key Blank 6-Pin



## CABLES



**Features:**

- Locking mechanism holds the cable tight at any position from 1' to 6' for infinite locking positions
- Interchangeable cables for application flexibility
- Rekeyable cylinders for keyed alike convenience
- Standard M1 key cut
- 3/8" outside diameter, 100% steel braided cable
- Weather tough and rust resistant lock body
- Vinyl sleeve and lock body bumper resists scratching
- Velcro strap holds excess cable for compact storage

**Lock & Cable; Yellow Body with Black Bumper** Cable Length

ML8413DPF	Keyed Different	6'
ML8413KA#3210	Keyed Alike	6'

**Mix & Match Products**

ML8491	Rekeying Parts Kit	-
--------	--------------------	---

**No. 8154 Cable Lock**

Keyed Different, Series Packaging



6' x 3/8"  
Smoke Cable with Yellow  
Lock Body Connectors

**Features:**

- Ideal for bicycles, skateboards, and sports equipment
- Integrated key locking mechanisms for strong pick resistance
- Flexible steel cables for strong cut resistance
- Protective coating helps prevent scratching

ML8154DPF

**No. 8119 Cable Lock**

Integrated Set-Your-Own Combination Barrel Lock



ML8119DPF  
5' x 3/8" Cable

**Features:**

- Flexible braided steel cables for strong cut resistance
- Combination locking mechanisms for keyless convenience
- Set-your-own combination convenience and security
- Protective coating helps prevent scratching and rusting
- Ideal for bicycles, sports equipment, ladders and generators

**No. 78 & 79 Heavy Duty Cables**



ML78DPF  
6' x 3/8" Coated Cable

**Features:**

- Galvanized steel cable resists rusting
- Braided steel wires for strength and flexibility
- Black vinyl coating helps prevent scratching
- Convenient loops with rust-resistant sleeves and scratch guards
- Recommended use with laminated, solid steel and mini U-Locks

**No. 65 General Use Cables**



ML65D  
6' Self-coiling cable

**Features:**

- Woven steel cables for strong cut resistance
- Strong loops for use with Master Lock padlocks
- Protective coating helps prevent scratching

## ACCESSORIES

**Patio Security Bar**



**Features:**

- Dual door & patio security bar, for hinged or sliding doors
- Adjusts to fit most standard doors
- Pivoting ball joint assures full contact with floor
- Padded foot protects floor from scratching
- Prevents forced entry
- Push-button adjustment
- Locking system keeps bar in place

ML265DCCSEN

**No. 1710 and 1714 Locker Locks**



**Features:**

- High security, 5 pin tumbler cylinder for superior pick resistance
- Easy to install; designed to fit most lockers
- Two keys provided per each lock

ML1710

Built-in key operated deadbolt lock for lockers with either right-handed or left-handed doors; keyed different

ML1714

Built-in key operated automatic locking springbolt lock for lockers with either right-handed or left-handed doors; keyed different



**ACCESSORIES — continued**

**No. 5400 and 5401 Select Access Key Storage**



**5400D**  
Portable



**5401D**  
Wall Mount

5400 Key Storage Dimensions			
Model	A	B	C
ML5400D	13/32"	1 13/32"	1 7/8"
ML5401D	NA	NA	NA

- Features:**
- The safest place for your key
  - No lockouts or schedule conflicts
  - Set your own combination convenience
  - Resettable to allow for a personalized combination

**KeyBlanks**



- |                       |                |
|-----------------------|----------------|
| <b>KW1 KEYBLANK</b>   | <b>MLK2245</b> |
| <b>SC1 KEYBLANK</b>   | <b>MLK2246</b> |
| <b>WR3/5 KEYBLANK</b> | <b>MLK2247</b> |



**ML5440D** Bluetooth Lock Box Portable  
**ML5440ENT** Enterprise Bluetooth Padlock



**ML5441D** Bluetooth Lock Box Wall Mount  
**ML5441ENT** Enterprise Bluetooth Outdoor

**No. 420 Safety Lockout**



- Features:**
- Heavy duty gauge steel resists prying
  - 1" Diameter jaws
  - Each hasp allows for lockout by up to 6 workers
  - Compatible with No. 3, 410, 411 and 6835 and 6836 safety lockout padlocks

**ML420** Red Safety Lockout

**No. 4680 Padlock**



- Features:**
- TSA-Accepted luggage lock - ideal for air travel
  - Durable metal construction
  - Set-your-own combination convenience
  - 1 1/4" wide body

**ML4680DBLK** Black Finish  
**ML4680DNKL** Nickel Finish

**All Cuff Locks**

- Compact and lightweight – easily fit in cargo areas
- 3" cuffs fit fork legs or frames; can be secured to sign posts, parking meters or another bike
- Heat treated patent lock core is virtually pick proof
- Pivoting action combined with 22" length provides lockdown versatility

**ML8290DPS**

- Hardened, chrome plated steel resists cutting or prying
- Folds in half for convenient storage



**No. 71 Accessories**



- |                 |   |
|-----------------|---|
| <b>ML71CH</b>   | • 9" Long Heavy Duty Zinc Plated Steel Chain<br>• Fits all Master Shackle Collars except 71SC7  |
| <b>ML71CS</b>   | • 9" Long Lightweight Zinc Plated Steel Chain<br>• Fits all Master Shackle Collars  |
| <b>ML71SC9</b>  | • Collar, Fits 9/32" dia shackles & smaller<br>• For No. 3, 4, 11, 500, 1500 and 1525 locks   |
| <b>ML71SC10</b> | • Collar, Fits 5/16" dia shackles & smaller<br>• For No. 1, 2, 21, 24, 81, 82, 101, 175, 2001, 2002, 2010, 6121, 6840, 6841, 6842, 7040, 7041, and 7042 locks |
| <b>ML71SC12</b> | • Collar, Fits 3/8" dia shackles & smaller<br>• For No. 5, 6, 25, 6125, 6850, 6851, 6852, 7050, 7051, and 7052 locks  |
| <b>ML71SC14</b> | • Collar, Fits 7/16" dia shackles & smaller<br>• For No. 15, 17, 220, 230, 27, 6230 and 6237 locks  |

## ACCESSORIES — continued



**No. 5900D SafeSpace Portable Safe**

**Features:**

- Ideal for recreation, campus, office, travel, or leisure use
- Lightweight and portable
- Water-Resistant
- Set-your-own combination
- Ear Bud/Charging cable access port
- Protects MP3 players, cell phones, cameras, gaming devices, cash, credit cards, jewelry, keys, passports, and other small valuables
- Lock Up & Lock Down. Lock up valuables with the cable wrapped tightly to the safe or wrapped securely around a fixed object. Cable doubles as a carrying handle

ML5422D	Portable Pushbutton Lock Box
ML5423D	Wall Mount Pushbutton Lock Box
ML5900D	Personal Safe - Black
ML5424D	Safespace Portable Light-Up Safe
ML5425D	Space Wall Mount Light-Up
ML5900D	Safespace Personal Safe Black
ML5900DWH	Safespace Personal Safe White

## HASPS

**Heavy Duty Hasps**



**ML730DPF**  
7 1/4" Straight Bar, Retail Carded Product

**Features:**

- Zinc plated hardened steel for added strength and weatherability
- Hardened steel staple resists cutting, sawing and hammering
- Hasp body conceals mounting hardware
- Mounting hardware included for easy installation
- Ideal for utility vans, trailers, gang boxes, vending machines



**ML731DPF**  
90° Angle Bracket, Retail Carded Product



**ML732DPF**  
90° Angle Bracket, Retail Carded Product

---

**Hinged Hasps**



**ML720DPF**  
6 1/4" Single Hinge, Retail Carded Product

**Features:**

- Secure hard-to-lock property
- Hardened steel body for added strength
- Hardened boron alloy staples resist cutting and sawing
- Ideal for reaching around corners and angles

**Solid Steel Hasp**



**ML770**  
9" Wide x 4 1/2" High

**Features:**

- Works only with the model 6270 lock
- Ideal for vans, trucks, gates, and vending
- Defeats attempts to pry and cut

---

**General Use Hasps**

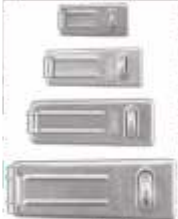

**Features:**

- Hard steel bodies for strength
- Hardened steel staples resist cutting and sawing
- Hardened steel locking eyes for strong cut resistance
- Tamper proof hinges help resist prying

ML702D	2 1/2" Carded
ML703D	3 1/2" Carded
ML704DPF	4 1/2" Carded
ML706D	6" Carded with Reinforced Plate

**Hasplocks**



**Features:**

- Hasps with integral locking mechanisms for security and convenience
- Hardened steel hasps with 1 3/4" laminated steel lock body
- Ribbed hasp plate for extra strength
- Hardened steel locking eye for strong cut resistance

**ML475** Keyed Different, Retail Carded Product

## AUTOMOTIVE

**Receiver Locks**



**Features:**

- Hardened receiver pins for increased shear strength
- Precision 4-pin tumbler mechanism resists picking
- Key retaining for increased safety
- K1 key blank for all receiver locks

ML1472DAT	Class II Barbell Receiver; 1/2" Pin
ML1479DAT	Class III / IV Snap-on Receiver Hitch Lock; 5/8" Pin
ML1480DAT	Stainless Steel; Fits Both 5/8" (16mm) & 1/2" (13mm) Receiver Holes; 2 1/2" (64mm) Long Shackles



**AUTOMOTIVE — continued**

**Coupler Locks**



379DAT



ML1475DAT

**Features:**

- Adjusts to fit many makes and models
- No. 379DAT features a rubberized plastic body
- No. 379ATPY features chrome plated body
- Keyway cover protects lock from moisture and dirt

- ML379ATPY Universal Rekeyable fits 1 3/8", 2", 2 3/8"
- ML379DAT Universal fits 1 3/8", 2", 2 3/8"
- ML2847DAT Adjustable to 5/8", 1", 2"
- ML1475DAT Coupler Latch Lock - Retail Carded - KA

**Towing Security**



ML3794DAT

**Features:**

- Set includes 2866DAT, 2847DAT and 379DAT
- Addresses all trailer security needs - Coupler, Coupler Latch and Receiver Lock
- All packaged in a durable canvas storage bag
- Trailer coupler lock fits 1 3/8", 2" and most 2 3/8" couplers
- Push to Lock™ receiver lock fits both 1/2" and 5/8" receivers
- Trailer coupler lock fits 1 3/8", 2" and most 2 3/8" couplers
- Stainless steel trailer coupler latch lock is adjustable from 9/16" to 2 3/4"

**Trailer Locks**



**Features:**

- Protect unattended trailers
- Rugged die-cast zinc body resists corrosion
- 4-pin tumbler cylinder helps prevent picking

ML34AT Keyed Different

**DEADBOLTS**

**Keypad Deadbolt SC1 Keyway Box Pack**

ML DSKP0603P



Both NightWatch deadbolts and NightWatch Combination deadbolts feature BumpStop Advance Cylinder Technology which has proven to be 4 times more resistant to bumping attacks than the toughest proposed industry standards for bump resistance.

MLDSKP0612P Aged Bronze

**Nightwatch® Residential Single Cylinder Deadbolt**



NightWatch® deadbolts were specifically created by Master Lock Company to prevent an intruder from entering, even if they have a copy of the homeowner's key. It installs and functions like a standard deadbolt but once the exclusive NightWatch® feature is activated, all keys are blocked from unlocking the deadbolt

Code	Keyway
SC1	Schlage C
WR3	Weiser

Code	Finish
PB	Polished Brass
AB	Antique Brass
ABZ	Aged Bronze
SN	Satin Nickel

MLDSO0603D045KA	PB	SC1
MLDSO0603D135KA	PB	WR3
MLDSO0605D045KA	AB	SC1
MLDSO0605D135KA	AB	WR3
MLDSO0612PD045KA	ABZ	SC1
MLDSO0612PD135KA	ABZ	WR3
MLDSO0615D045KA	SN	SC1
MLDSO0615D135KA	SN	WR3



**GRADE 1 DEADBOLTS**



MILDS0603KA4S  
MILDS0603KA4W  
MILDSh0603KA4

MILDSh0603KA4W  
MILDS0605KA4S  
MILDS0605KA4W  
MILDSh0605KA4  
MILDSh0605KA4S  
MILDSh0605KA4W  
MILDS0612PKA4S  
MILDS0612PKA4W  
MILDSh0612PKA4  
MILDSh0612PKA4S  
MILDSh0612PKA4W  
MILDS0615KA4S  
MILDS0615KA4W  
MILDSh0615KA4  
MILDSh0615KA4S  
MILDSh0615KA4W

DBOLT SINGLE PB SC1 KA4  
DBOLT SINGLE PB WR3 KA4  
GRADE 1 SINGLE DBOLT KW1 PB  
GRADE 1 SINGLE DBOLT SC1 PB  
GRADE 1 SINGLE DBOLT WR5 PB  
DBOLT SINGLE AB SC1 KA4  
DBOLT SINGLE AB WR3 KA4  
GRADE 1 SINGLE DBOLT KW1 AB  
GRADE 1 SINGLE DBOLT SC1 AB  
GRADE 1 SINGLE DBOLT WR5 AB  
DBOLT SINGLE ABZ SC1 KA4  
DBOLT SINGLE ABZ WR3 KA4  
GRADE 1 SINGLE DBOLT KW1 ABZ  
GRADE 1 SINGLE DBOLT SC1 ABZ  
GRADE 1 SINGLE DBOLT WR5 ABZ  
DBOLT SINGLE SN SC1 KA4  
DBOLT SINGLE SN WR3 KA4  
GRADE 1 SINGLE DBOLT KW1 SN  
GRADE 1 SINGLE DBOLT SC1 SN  
GRADE 1 SINGLE DBOLT WR5 SN

**CYLINDER LEVERS/ DEADBOLTS**



MILD045G3BCLL03  
MILD045G3BCLL15  
MILD045G3SD03  
MILD045G3SD05  
MILD045G3SD12P  
MILD045G3SD15  
MILD125G3BCLL03  
MILD125G3BCLL15  
MILD125G3SD03  
MILD125G3SD05  
MILD125G3SD12P  
MILD125G3SD15  
MILD135G3BCLL03  
MILD135G3BCLL15  
MILD135G3SD03  
MILD135G3SD05  
MILD135G3SD12P  
MILD135G3SD15

CYLINDER BISCUIT/LEVER PB SC1  
CYLINDER BISCUIT/LEVER SN SC1  
CYLINDER SGL DBOLT PB SC1  
CYLINDER SGL DBOLT AB SC1  
CYLINDER SGL DBOLT ABZ SC1  
CYLINDER SGL DBOLT SN SC1  
CYLINDER BISCUIT/LEVER PB KW1  
CYLINDER BISCUIT/LEVER SN KW1  
CYLINDER SGL DBOLT PB KW1  
CYLINDER SGL DBOLT AB KW1  
CYLINDER SGL DBOLT ABZ KW1  
CYLINDER SGL DBOLT SN KW1  
CYLINDER BISCUIT/LEVER PB WR3  
CYLINDER BISCUIT/LEVER SN WR3  
CYLINDER SGL DBOLT PB WR3  
CYLINDER SGL DBOLT AB WR3  
CYLINDER SGL DBOLT ABZ WR3  
CYLINDER SGL DBOLT SN WR3



**KNOBS**



Part Number	Function	Knob Type	Finish	Keyway
MLBC0103KA4S	Entry	Biscuit	Polished Brass	WR3
MLBC0103KA4W	Entry	Biscuit	Polished Brass	WR3
MLBC0105KA4S	Entry	Biscuit	Antique Brass	SCI
MLBC0105KA4W	Entry	Biscuit	Antique Brass	WR3
MLBC0112PKA4S	Entry	Biscuit	Antique Bronze	SCI
MLBC0112PKA4W	Entry	Biscuit	Antique Bronze	WR3
MLBC0403BOX	Passage	Rusk	Antique Brass	N/A
MLTU0105KA4W	Entry	Tulip	Antique Brass	WR3
MLRU0103KA4S	Entry	Rusk	Polished Brass	SCI
MLRU0103KA4W	Entry	Rusk	Polished Brass	WR3
MLRU0105KA4S	Entry	Rusk	Antique Brass	SCI
MLRU0105KA4W	Entry	Rusk	Antique Brass	WR3
MLRU0112PKA4S	Entry	Rusk	Antique Bronze	SCI
MLRU0112PKA4W	Entry	Rusk	Antique Bronze	WR3
MLRU0115KA4S	Entry	Rusk	Satin Nickel	SCI
MLRU0115KA4W	Entry	Rusk	Satin Nickel	WR3
MLRU0303BOX	Privacy	Knob	Polished Brass	N/A
MLRU0305BOX	Privacy	Knob	Antique Brass	N/A
MLRU0312PBOX	Privacy	Knob	Antique Bronze	N/A
MLRU0315BOX	Privacy	Knob	Satin Nickel	N/A
MLRU0403BOX	Passage	Knob	Polished Brass	N/A
MLRU0405BOX	Passage	Knob	Antique Brass	N/A
MLRU0412PBOX	Passage	Knob	Antique Bronze	N/A
MLRU0415BOX	Passage	Knob	Satin Nickel	N/A



### COMBO KNOBS



Part Number	Function	Knob Type	Finish	Keyway
MLBCC0603KA4	Entry/SGL DB	Biscuit	Polished Brass	KWI
MLBCC0603KA4S	Entry/SGL DB	Biscuit	Polished Brass	SCI
MLBCC0603KA4W	Entry/SGL DB	Biscuit	Polished Brass	WR3
MLBCC0605KA4	Entry/SGL DB	Biscuit	Antique Brass	KWI
MLBCC0605KA4S	Entry/SGL DB	Biscuit	Antique Brass	SCI
MLBCC0605KA4W	Entry/SGL DB	Biscuit	Antique Brass	WR3
MLBCC0612PKA4	Entry/SGL DB	Biscuit	Aged Bronze	KWI
MLBCC0612PKA4S	Entry/SGL DB	Biscuit	Aged Bronze	SCI
MLBCC0612PKA4W	Entry/SGL DB	Biscuit	Aged Bronze	WR3
MLBCC0615KA4	Entry/SGL DB	Biscuit	Satin Nickel	KWI
MLBCC0615KA4S	Entry/SGL DB	Biscuit	Satin Nickel	SCI
MLBCC0615KA4W	Entry/SGL DB	Biscuit	Satin Nickel	WR3

### COMBO LEVERS



Part Number	Function	Lever Type	Finish	Keyway
MLWLC0603DKA4	Entry/SGL DB	Wave	Polished Brass	KWI
MLWLC0603DKA4S	Entry/SGL DB	Wave	Polished Brass	SCI
MLWLC0603DKA4W	Entry/SGL DB	Wave	Polished Brass	WR3
MLWLC0603KA4	Entry/SGL DB	Lever	Polished Brass	KWI
MLWLC0603KA4S	Entry/SGL DB	Lever	Polished Brass	SCI
MLWLC0603KA4W	Entry/SGL DB	Lever	Polished Brass	WR3
MLWLC0612PKA4	Entry/SGL DB	Wave	Aged Bronze	KWI
MLWLC0612PKA4S	Entry/SGL DB	Wave	Aged Bronze	SCI
MLWLC0612PKA4W	Entry/SGL DB	Wave	Aged Bronze	WR3
MLWLC0615DKA4	Entry/SGL DB	Wave	Satin Nickel	KWI
MLWLC0615DKA4S	Entry/SGL DB	Wave	Satin Nickel	SCI
MLWLC0615DKA4W	Entry/SGL DB	Wave	Satin Nickel	WR3
MLWLC0615KA4	Entry/SGL DB	Lever	Satin Nickel	KWI
MLWLC0615KA4S	Entry/SGL DB	Lever	Satin Nickel	SCI
MLWLC0615KA4W	Entry/SGL DB	Lever	Satin Nickel	WR3

**HINGES**



TA2714



RCTA2714



T2714



1502

Product #	Finish	Description		
<b>Full Mortise Hinges TA2714 Series - 4.5" x 4.5" Square Corner</b>				
MC55858	US26D		<ul style="list-style-type: none"> <li>• Steel</li> <li>• Standard Weight</li> <li>• 5 Knuckle Bearing</li> <li>• Gauge 0.134</li> </ul>	
MC55860	US26D	NRP		
MC55862	US10B			
MC55875	US10B	NRP		
<b>Full Mortise Hinges RCTA2714 Series - 4.5" x 4.0" Round Corner</b>				
MC55797	US26D		<ul style="list-style-type: none"> <li>• Steel</li> <li>• Standard Weight</li> <li>• 5 Knuckle Bearing</li> <li>• Gauge 0.134</li> </ul>	
MC55798	US26D	NRP		
MC55799	D3			
MC55800	D3	NRP		
<b>Full Mortise Hinges T2714 Series - 4.5" x 4.5" Square Corner</b>				
MC55755	US26D			
MC55767	US4			
<b>Full Mortise Hinges MacPro Series - 4.5" x 4.5" Square Corner</b>				
MC76374	US26D		Steel	<ul style="list-style-type: none"> <li>• Heavy Weight</li> <li>• 5 Knuckle Bearing</li> <li>• Gauge 0.180</li> </ul>
MC76375	US26D	NRP	Steel	
MC76376	US32D		Stainless	
MC76377	US32D	NRP	Stainless	
<b>Full Mortise Spring Hinges 1502 Series - 4.5" x 4.5" Square Corner</b>				
MC156019	US4		<ul style="list-style-type: none"> <li>• Steel Standard Weight</li> <li>• Single-Acting</li> </ul>	
MC156023	US26D			

**TA 2714 - Full Mortise - Steel - Standard Weight  
5 Knuckle - Ball Bearing**

Hager	Item #	Corner	Size	Finish	NRP
BB1279	55820	Square	4.5 x 4.5	Prime	
	55858	Square	4.5 x 4.5	26D	
	55860	Square	4.5 x 4.5	26D	Yes
RCBB1279	55797	Round	4.5 x 4	26D	
	55798	Round	4.5 x 4	26D	Yes
	55799	Round	4.5 x 4	D3	
	55800	Round	4.5 x 4	D3	Yes

**T 2714 - Full Mortise Hinges - Steel - Standard Weight  
5 Knuckle**

Hager	Item #	Corner	Size	Finish	NRP
1279	55755	Square	4.5 x 4.5	26D	
	55767	Square	4.5 x 4.5	4	

**1502 - Spring Hinges - Steel - Standard Weight  
5 Knuckle**

Hager	Item #	Corner	Size	Finish	NRP
1250	156019	Square	4.5 x 4.5	4	
	156023	Square	4.5 x 4.5	26D	



# Medeco CLIQ® Go Is a Win-Win for Locksmiths.

*"We've made it easy and economical for every locksmith to become a Medeco CLIQ Go Dealer."*



**Add Medeco CLIQ Go to your shop.  
Sell to your small- to mid-sized business customers.  
Here's how you'll benefit:**

- Some customers only need access control on a handful of doors. *Now you've got a solution!*
- CLIQ Go will generate a recurring revenue stream for your shop. *Nice!*
- CLIQ Go is a simple retrofit; it's easy to install and expand as customers' needs change.
- Medeco has cost-effective starter packages for your shop and provides the training.

*"Now's the best time to upgrade your shop  
with intelligent key systems."*



## **Start a Recurring Revenue Stream Now.**

Learn how to earn recurring revenue through software subscriptions and system expansion for your small to mid-sized business customers. Visit [www.medeco.com/cliqgo](http://www.medeco.com/cliqgo) or contact Medeco Customer Service at 1-800-839-3157.



**MORTISE CYLINDERS**



**STANDARD**

MD100100	5 Pin 1" Mortise Cylinder
MD100200	6 Pin 1-1/8" Mortise Cylinder
MD100500	6 Pin 1-1/4" Mortise Cylinder
MD105100	6 Pin 1-3/8" Mortise Cylinder
MD105200	6 Pin 1-1/2" Mortise Cylinder
MD105300	6 Pin 1-5/8" Mortise Cylinder

**LIMITED ROTATION**

MD100501	6 Pin 1-1/4" Mortise Cylinder Hotel Function
----------	---

**MORTISE CYLINDER PARTS**

**PLUGS**

MD1202100T	Plug For Mortise Cylinder 10T0100 MEDECO 3
MD12005002 -	Plug For Mortise Cylinder 10-0200 ORIGINAL
MD12005006 W	Plug For Mortise Cylinder 10W0200 BIAXIAL
MD1200500T	Plug For Mortise Cylinder 10T0200 MEDECO 3

**COMPONENTS**

MDCP-010203-030	Cam Screw 10□0100 #2-56 X 3/16" FLAT HEAD
MDCP-010203-050	Cam Screw 10□0200 #2-56 X 5/16" FLAT HEAD
MDCP-021011	Mortise Cyl Cam Washer
MDCP-030009	Stop Pin Spring Hotel Mort
MDCP-060404	Stop Pin Hotel Mort

**CAMS**

MDCT-Z00	CAM CORBIN RUSSWIN TYPE
MDCT-Z01	CAM STANDARD YALE TYPE
MDCT-Z02	CAM ADAMS RITETYPE
MDCT-Z04	CAM KEIL NORWALK TYPE
MDCT-Z05	CAM SCHLAGE TYPE
MDCT-Z06	CAM MEDIUM YALE TYPE
MDCT-Z07	CAM SEGAL TYPE
MDCT-Z08	CAM LOCKWOOD TYPE
MDCT-Z09	CAM CORBIN RUSSWIN TYPE
MDCT-Z16	CAM SEGAL DEADBOLT TYPE
MDCT-Z17	CAM CORBIN RUSSWIN JUMBO
MDCT-Z18	CAM FOR NIGHT DEPOSIT
MDCT-Z19	CAM GENERAL LOCK
MDCT-Z20	CAM SARGENT TYPE
MDCT-Z21	CAM RUKO TYPE
MDCT-Z22	CAM FALCON TYPE
MDCT-Z34	CAM SCHLAGE TYPE
MDCT-Z45	CAM MOGUL LOCK
MDCT-Z47	CAM YALE MORT AFTER 1982
MDCT-Z48	CAM DOMINION
MDCT-Z55	CAM OVERSIZE CORBIN JUMBO
MDCT-Z56	CAM YALE MEDIUM POST 1982
MDCT-Z57	CAM MEDECO RESIDENTIAL
MDCT-Z58	CAM FALCON TYPE
MDCT-Z59	CAM CORBIN RUSSWIN CLOVER LEAF
MDCT-Z61	CAM HOOKTYPE DETENTION
MDCT-Z69	CAM CLOVER LEAF MOGUL
MDCT-Z70	CAM BEST HOTEL FUNCTION REVERSIBLE LOCK
MDCT-Z84	CAM MARKS J TYPE
MDCT-Z87	CAM VING CARD PERSONA
MDCT-Z99	CAM FALCON TYPE

**RIM CYLINDERS**

**STANDARD**

MD100300H	5 PIN 1-1/16" RIM CYLINDER
MD100400H	6 PIN 1-1/8" RIM CYLINDER
MD100403V	6 PIN 1-1/8" RIM CYLINDER Sargent Mounting Style

**LAZY MOTION**

MD1065140	EMTEK 5 PIN RIM CYLINDER Lazy Motion, Handleset & Deadbolt, Outside
-----------	---

**RIM CYLINDER PARTS**

**PLUGS**

MD12030002 -	PLUG FOR RIM CYLINDER 10-0400 Original
MD12030006 W	PLUG FOR RIM CYLINDER 10W0400 Bi axial
MD1203000T	PLUG FOR RIM CYLINDER 10T0400 Medeco 3

**COMPONENTS**

MDCP-012917-000	RIM MTG SCREW 10□0400 #12-24 X 1-57/64"
-----------------	--

**COMPONENTS (Continued)**

MDCP-020010	PLUG RETAINER RIM CYLINDER TRU-ARC
MDCP-021021	PLUG RETAINER RIM CYLINDER Old Style
MDCP-021121	TPLC RETAINER FOR RIM CYL Brass Screw Cap
MDCP-060203	PLUG ROLL PIN 3/32" DIA. X .437"
MDCP-180031	RIM CYL BACK PLATE STANDARD
MDCP-180171	RIM CYL BACK PLATE SARGENT
MDCT-F40	TAILPIECE BALDWIN IMAGES Lazy Motion
MDCT-V50	TAILPIECE LAZY MOTION EMTEK DBL CYL DB
MDCT-V51	TAILPIECE LAZY MOTION EMTEK SGL CYL DB
MDCT-Y02	TAILPIECE RIM CYLINDER Standard
MDCT-Y08	TAILPIECE RIM CYLINDER Lazy Motion
MDCT-Y32	TAILPIECE RIM CYLINDER Sargent

**DEADBOLTS**

**RESIDENTIAL ASSEMBLY LESS BOLT**

MD11R50L	5 Pin Single Cylinder	Residential Trim
MD11R52L	5 Pin Double Cylinder	Residential Trim
MD11R60L	6 Pin Single Cylinder	Residential Trim
MD11R62L	6 Pin Double Cylinder	Residential Trim
MD11R63L	6 Pin Double Cylinder	Residential Trim Captive Thumbturn

**COMMERCIAL ASSEMBLY LESS BOLT**

MD11C60L	6 Pin Single Cylinder	Commercial Trim
MD11C62L	6 Pin Double Cylinder	Commercial Trim
MD11C63L	6 Pin Double Cylinder	Commercial Trim Captive Thumbturn

**COMMERCIAL ASSEMBLY WITH BOLT LESS CORE**

MD11C402	Single Llc Db Less Core	1 1/8" Faceplate 2 3/4" Bs	Commercial Trim
MD11C702	Single Slc Db Less Core	1 1/8" Faceplate 2 3/4" Bs	Commercial Trim

**DEADBOLT PARTS**

**BOLTS ONLY**

MD11-0A1911-06	2-3/8" X 1" BOLT OPT #3	For Finishes -05/-06/-09
MD11-0A1911-12	2-3/8" X 1" BOLT OPT #3	For Finishes -12
MD11-0A1911-24	2-3/8" X 1" BOLT OPT #3	For Finishes -10/-24
MD11-0A1911-26	2-3/8" X 1" BOLT OPT #3	For Finishes -19/-26
MD11-0A1912-06	2-3/8" X 1-1/8" BOLT OPT #1	For Finishes -05/-06/-09
MD11-0A1912-12	2-3/8" X 1-1/8" BOLT OPT #1	For Finishes -12
MD11-0A1912-24	2-3/8" X 1-1/8" BOLT OPT #1	For Finishes -10/-24
MD11-0A1912-26	2-3/8" X 1-1/8" BOLT OPT #1	For Finishes -19/-26

MD11-0A1913-26	2-3/8" D.I. BOLT OPT #5	For Finishes -19/-26
MD11-0A1921-06	2-3/4" X 1" BOLT OPT #4	For Finishes -05/-06/-09
MD11-0A1921-12	2-3/4" X 1" BOLT OPT #4	For Finishes -12
MD11-0A1921-24	2-3/4" X 1" BOLT OPT #4	For Finishes -10/-24
MD11-0A1921-26	2-3/4" X 1" BOLT OPT #4	For Finishes -19/-26
MD11-0A1922-06	2-3/4" X 1-1/8" BOLT OPT #2	For Finishes -05/-06/-09
MD11-0A1922-24	2-3/4" X 1-1/8" BOLT OPT #2	For Finishes -10/-24
MD11-0A1922-26	2-3/4" X 1-1/8" BOLT OPT #2	For Finishes -19/-26
MD11-0A1923-26	2-3/4" D.I. BOLT OPT #6	For Finishes -19/-26

**RESIDENTIAL**

MD11-0A10-05	W/Base Plate Assembly
MD11-0A10-09	W/Base Plate Assembly
MD11-0A10-10	W/Base Plate Assembly
MD11-0A10-19	W/Base Plate Assembly
MD11-0A20-05	Fits Captive Key Org, Bia, Km
MD11-0A20-09	Fits Captive Key Org, Bia, Km
MD11-0A20-19	Fits Captive Key Org, Bia, Km
MD11-0A21-05	Fits Captive Key M3, X4
MD11-0A21-09	Fits Captive Key M3, X4
MD11-0A21-19	Fits Captive Key M3, X4
MD11-0A23-05	W/Set Screw

**THUMBTURNS**

MD11-0A23-09	W/Set Screw
MD11-0A23-19	W/Set Screw
<b>COMMERCIAL</b>	
MD11-0018-05	Fits Captive Key M3, X4
MD11-0018-09	Fits Captive Key M3, X4
MD11-0018-26	Fits Captive Key M3, X4
MD11-0092-09	Fits Captive Key Org, Bia, Km
MD11-0092-12	Fits Captive Key Org, Bia, Km
MD11-0092-26	Fits Captive Key Org, Bia, Km
MD11-0A12-26	W/Base Plate Assembly
MD11-0A22-26	W/Set Screw

**PLUGS FOR MAXUM DEADBOLT**

MD12028002 -	Original
MD12028006 W	Blaxdal
MD1202800 T	Medeco 3
MD1202900 T	Medeco 3 W/ Captive Cut Out

**DEADBOLT COMPONENTS**

MD94-0029	Inside Cyl Trim Plate Package	For Maxum Dbl Cyl Db
MD94-0059	Round Front Assembly	For Maxum Bolt
MD94-0210	T-Turn Trim Plate Package	For Maxum Sgl Cyl Db

MD94-0212	Spacer Rings For 1-3/8" Dr	Maxum Deadbolt (Pkg Of 2)
MDCP-011749	Screw Pack For Max Db	SFIC Sgl Cylinder
MDCP-011757	Screw Pack For Max Db	Classroom Function
MDCP-011762	Screw Pack For Max Db	5 & 6-Pin Sgl Cylinder
MDCP-011764	Screw Pack For Max Db	6-Pin Dbl Cylinder
MDCP-012409-030	SET SCREW FOR RES DB T-TURN	
MDCP-012411-030	SET SCREW FOR CAPT T-TURN	#6-32 X 3/16"



**DEADBOLT COMPONENTS (Continued)**

MD94-0029	Inside Cyl Trim Plate Package For Maxum Dbl Cyl Db	MDCP-021090	Dbl Cyl Captive Db RETAINER FOR DBL CYL DB TRIM Plate Snap Ring
MD94-0059	Round Front Assembly For Maxum Bolt	MDCP-181690	SECURITY RING MAXUM
MD94-0210	T-Turn Trim Plate Package For Maxum Sgl Cyl Db	MDCP-250010	BALL MAXUM DB .191 DIA Silver
MD94-0212	Spacer Rings For 1-3/8"Dr Maxum Deadbolt (Pkg Of 2)	MDCP-250020	BALL MAXUM DB .202 DIA Black
MDCP-011749	Screw Pack For Max Db SFIC Sgl Cylinder	MDCP-260220	SECURITY SLEEVE MAXUM
MDCP-011757	Screw Pack For Max Db Classroom Function	MDCT-F38	TAILPIECE 14 SERIES DB SGL CYL
MDCP-011762	Screw Pack For Max Db 5 & 6-Pin Sgl Cylinder	MDCT-F41	TAILPIECE T-TURN MAXUM STD Up To 2"
MDCP-011764	Screw Pack For Max Db 6-Pin Dbl Cylinder	MDCT-F42	TAILPIECE T-TURN MAXUM STD 1-3/4" To 2-1/2"
MDCP-012409-030	SET SCREW FOR RES DB T-TURN	MDCT-F43	TAILPIECE T-TURN MAXUM CLS 1-3/4" To 2"
MDCP-012411-030	SET SCREW FOR CAPT T-TURN #6-32 X 3/16"	MDCT-F44	TAILPIECE T-TURN MAXUM CLS 2-1/4" To 2-1/2"
MDCP-012413-020	SET SCREW FOR DB T-TURN TPLC #8-32 X 1/8"	MDCT-V34	TAILPIECE MAXUM SFIC
MDCP-012413-040	SET SCREW FOR DB T-TURN HUB #8-32 X 1/4"	MDCT-V48	TAILPIECE MAXUM THICK DOOR 1-3/4" To 2-1/2"
MDCP-020140	RETAINING RING FOR T-TURN HUB Tru-Arc	MDCT-V49	TAILPIECE MAXUM STANDARD Up To 1-3/4"
MDCP-021061	PLUG RETAINER DEADBOLT Old Style	MDCT-V56	TAILPIECE 14 SERIES DB DBL CYL
MDCP-021081	KEY RETAINING LEVER FOR MAXUM	MDCT-Y60	TAILPIECE MAXUM STANDARD Old Version Up To 1-3/4"
		MDCT-Y61	TAILPIECE MAXUM THICK DOOR Old Version 1-3/4" To 2-1/2"
		MDCT-Y90	TAILPIECE T-TURN DB STD Old Version Up To 2-1/2"

**DEADBOLT CYLINDERS**

MD2000854	5 PIN SCHLAGE B, E, F160 Kik Lazy Motion Cylinder
MD2000954	6 PIN SCHLAGE B, E, F160 Kik Lazy Motion Cylinder
MD200901	6 PIN ARROW/SARGENT SINGLE Kik Lazy Motion Cylinder

**DEADBOLT CYLINDER PARTS - PLUGS**

MD1226633 T	PLUG FOR DEADBOLT CYLINDER 20T00900 Medeco 3
-------------	---

**DEADBOLT CYLINDER PARTS - COMPONENTS**

MDCP-010503-040	LAZY MOTION RETAINER SCREW #2-56 X 1/4" Pan Head
MDCP-021031	TPLC / Plug Retainer For Lazy Motion Kik
MDCP-030670	Compression Spring For Lazy Motion Kik
MDCP-041200	RETAINER DISK FOR DB CYL TLPC Lazy Motion Kik
MDCP-064490	DETENT PIN FOR PLUG Lazy Motion Kik
MDCT-Y24	TAILPIECE LAZY MOTION Schlage Dbl Cyl Db .524
MDCT-Y27	TAILPIECE LAZY MOTION Bald Falcon Weiser Yale

**KIK / KIL CYLINDERS**

MD200503	6 PIN YALE 5300LN, 5400LN Kil Cylinder		
MD20200H1	6 PIN ARROW & SCHLAGE ASSY Kik/Kil Cylinder		
MD20200S1	6 PIN SCHLAGE A, AL, C, D, ND Kik/Kil Cylinder		
MD20200V1	6 PIN ALARM LOCK/MARKS AB, F Kil Cylinder	MD2051500	6 PIN KABA E-PLEX 2000 Kil Cylinder
MD2020349	6 PIN SARGENT 7L, 8L, 10-LINE Kil Cylinder	MD208006	6 PIN SARGENT 7, 8, 9-LINE Kil Cylinder
MD20211730	6 PIN COR/RUS 800, CL3300-CL3600 Kil Cylinder	MD2080147	6 PIN SARGENT 6500, 6, 7, 10-LINE Kik/Kil Cylinder
MD205005	6 PIN COR/RUS CK4200, UT5251 Kil Cylinder	MD2080148	6 PIN SARGENT 11-LINE Kil Cylinder





**KIK / KIL CYLINDER PARTS- PLUGS**

MD12126022 -	PLUG FOR KIK / KIL CYLINDER 20-200XX Original	MD1214333 T	PLUG FOR KIK CYLINDER 20T20173 Medeco 3
MD12126156 W	PLUG FOR KIK / KIL CYLINDER 20W200XX Biaxial	MD1227233 T	PLUG FOR KIK / KIL CYLINDER 20T80147 Medeco 3
MD1212633 T	PLUG FOR KIK / KIL CYLINDER 20T200XX Medeco 3		

**COMPONENTS**

MDCP-010203-050	PLUG RETAINER SCREW 20[200XX #2-56 X 5/16" Flat Head	MDCT-V19	TAILPIECE COR/RUS 3900 KIL Arrow Revolution
MDCP-020020	RETAINING RING KIK E-CLIP	MDCT-V35	TAILPIECE SARGENT 11-LINE
MDCP-020050	TLPC RETAINER 20[406 TRU-ARC	MDCT-Y49	TAILPIECE SCHLAGE AL Falcon B F
MDCP-020100	RETAINING RING 20[406 C-CLIP		TAILPIECE SCHLAGE KNOB A C D Ball Globe Sphere
MDCP-021021	PLUG RETAINER KIK CYLINDER Old Style	MDCT-Y52	TAILPIECE SCHLAGE A ORBIT
MDCP-021370	PLUG RETAINER STD KNOB	MDCT-Y53	TAILPIECE FALCON S
MDCP-041000	RETAINING WASHER 20[406	MDCT-Y54	TAILPIECE FALCON S HG
MDCP-160321	SPACER ARROW M	MDCT-Y58	TAILPIECE YALE 5400LN
MDCT-V00	TAILPIECE MARKS 190S	MDCT-Y67	TAILPIECE FALCON X HEAVY Except H And T
MDCT-V01	TAILPIECE MARKS 190AB	MDCT-Y68	TAILPIECE ARROW M/SARGENT
MDCT-V02	TAILPIECE PDQ SP		TAILPIECE FALCON X WITH H KNOB
MDCT-V03	TAILPIECE FALCON T SERIES	MDCT-Y70	TAILPIECE FALCON Y LEVER
MDCT-V11	TAILPIECE MARKS SCHLAGE KIL ENT, STR, INS	MDCT-Y71	TAILPIECE SCHLAGE ND AL Thick DR Arrow M-Ball
MDCT-V12	TAILPIECE MARKS SCHLAGE KIL CLS, VES, COM	MDCT-Y72	TAILPIECE SCHLAGE 45-101
MDCT-V13	TAILPIECE MARKS ARR / SAR KIL ENT, STR, INS	MDCT-Y73	TAILPIECE LSDA LEVER
MDCT-V14	TAILPIECE MARKS ARR / SAR KIL CLS, VES, COM	MDCT-Y74	TAILPIECE SCHLAGE S
		MDCT-Y78	
		MDCT-Y97	

**LFIC CORES, CYLINDERS & HOUSINGS**

**YALE 31-SERIES LFIC**

MD310100	6 PIN YALE LFIC CORE
MD310101	6 PIN 1-3/8" YALE LFIC CORE Mortise Cylinder
MD310175	6 PIN 1-3/8" YALE LFIC CORE Mortise Housing
MD310375H	6 PIN 1-1/2" YALE LFIC CORE Rim Housing

**SCHLAGE 32-SERIES LFIC**

MD322201	5 PIN SCHLAGE LFIC CORE (6 Pin Keymark)
----------	--

**COR/RUS 32-SERIES LFIC**

MD322301	6 PIN COR/RUS LFIC CORE
----------	-------------------------

**MEDECO 32-SERIES LFIC**

MD320200	6 PIN 1-1/4" MEDECO LFIC CORE Mortise Cylinder
MD320201	6 PIN MEDECO LFIC CORE
MD320275	6 PIN 1-1/4" MEDECO LFIC CORE Mortise Housing
MD320400H	6 PIN 1-1/4" MEDECO LFIC CORE Rim Cylinder
MD320475H	6 PIN 1-1/4" MEDECO LFIC CORE Rim Housing

**SARGENT 32-SERIES LFIC**

MD322401	
----------	--

**LFIC CORE PARTS**

MD94-0009	LFIC 5 PIN SPACER ADAPTER	MDCP-040350	CURVED WASHER FOR LFIC
MDCP-010203-030	CAM SCREW 32[0200	MDCP-130011	CAM ADAPTER FOR LFIC
MDCP-012915-300	RIM MTG SCREW 32[0400	MDCP-280100	RUBBER BUMPER
MDCP-020040	RETAINING RING FOR LFIC YALE	MDCT-V31	TAILPIECE MARKS MEDECO LFIC
MDCP-021101	LOCKING RETAINER FOR LFIC YALE	MDCT-V32	TAILPIECE MARKS MEDECO LFIC

**SFIC CORES & HOUSINGS**

**SFIC CORES & HOUSINGS**

MD33076011	6 PIN 1-1/4" SFIC CORE Mortise Housing
MD33076021	7 PIN 1-3/8" SFIC CORE Mortise Housing
MD33600006	6 PIN SFIC CORE
MD33600007	6 PIN SFIC CORE Extended Plug Head
MD33700006	7 PIN SFIC CORE
MD33700007	7 PIN SFIC CORE Extended Plug Head

**MEDECO B SFIC CORES**

MD336B010	6-PIN W/ UNCOMBINATED
MD337B010	7-PIN W/ UNCOMBINATED

**SFIC CORE PARTS**

MDCP-021810	PLUG RETAINER CLIP X4
MDCP-160390	SFIC INSIDE SPACER
MDCP-160400	SFIC OUTSIDE SPACER
MDCP-160420	SFIC SPACER FOR 6 PIN CORE IN 7 Pin Housing
MDCT-V05	TAILPIECE MARKS MEDECO SFIC CLS, VES, COM
MDCT-V15	TAILPIECE MARKS MEDECO SFIC ENT, STR, INS

**PADLOCKS**



**BRASS BODY 50-SERIES**

MD5074201	KR BRASS PADLOCK LESS CORE 2-1/4" SHACKLE 3/8" DIA
MD5075201	NKR BRASS PADLOCK LESS CORE 2-1/4" SHACKLE 3/8" DIA

**G8R 52-SERIES**

MD52110040	G8R PADLK 5/16" STAINLESS Less Pop-Out Cylinder
MD52111040	G8R PADLK 5/16" HARDENED Less Pop-Out Cylinder
MD52120040	G8R PADLK 7/16" STAINLESS Less Pop-Out Cylinder
MD52121040	G8R PADLK 7/16" HARDENED Less Pop-Out Cylinder

**HOCKEY PUCK 52-SERIES**

MD52930L0	HOCKEY PUCK PADLOCK Less Cylinder
-----------	--------------------------------------

**SYSTEM SERIES 54-SERIES SFIC**

MD54315K0	PADLOCK LESS SFIC KR 5/16" X 1-1/8" Shackle
MD54315L0	PADLOCK LESS SFIC NKR 5/16" X 1-1/8" Shackle
MD5431FK0	PADLOCK LESS SFIC KR 5/16" X 2 3/8" Shackle
MD5431FL0	PADLOCK LESS SFIC NKR 5/16" X 2 3/8" Shackle
MD54415K0	PADLOCK LESS SFIC KR 7/16" X 1-3/8" Shackle
MD54415L0	PADLOCK LESS SFIC NKR 7/16" X 1-3/8" Shackle
MD5441FK0	PADLOCK LESS SFIC KR 7/16" X 1-7/8" Shackle
MD5441FL0	PADLOCK LESS SFIC NKR 7/16" X 1-7/8" Shackle

(Continued Next Page)

**PADLOCKS (CONTINUED)**

**SYSTEM SERIES 54-SERIES LFIC**

MD5461FL0 PADLOCK LESS LFIC NKR  
5/16" X 2-3/8" Shackle  
MD5461FR0 PADLOCK WITH LFIC KR  
5/16" X 2-3/8" Shackle

**SYSTEM SERIES 54-SERIES KIK**

MD5451500 PADLOCK WITH KIK NKR  
5/16" X 1-1/8" Shackle  
MD54515K0 PADLOCK LESS KIK KR  
5/16" X 1-1/8" Shackle  
MD54515L0 PADLOCK LESS KIK NKR  
5/16" X 1-1/8" Shackle  
MD54515R0 PADLOCK WITH KIK KR  
5/16" X 1-1/8" Shackle  
MD5451FK0 PADLOCK LESS KIK KR  
5/16" X 2-3/8" Shackle  
MD5451FL0 PADLOCK LESS KIK NKR  
5/16" X 2-3/8" Shackle  
MD5451FR0 PADLOCK WITH KIK KR  
5/16" X 2-3/8" Shackle

MD54525K0 PADLOCK LESS KIK KR SHROUDED  
5/16" X 3/4" Shackle  
MD54525L0 PADLOCK LESS KIK NKR SHROUDED  
5/16" X 3/4" Shackle  
MD54525R0 PADLOCK WITH KIK KR SHROUDED  
5/16" X 3/4" Shackle  
MD54715K0 PADLOCK LESS KIK KR  
7/16" X 1-3/8" Shackle  
MD54715L0 PADLOCK LESS KIK NKR  
7/16" X 1-3/8" Shackle  
MD54715R0 PADLOCK WITH KIK KR  
7/16" X 1-3/8" Shackle  
MD5471FK0 PADLOCK LESS KIK KR  
7/16" X 1-7/8" Shackle  
MD5471FL0 PADLOCK LESS KIK NKR  
7/16" X 1-7/8" Shackle  
MD54725K0 PADLOCK LESS KIK KR SHROUDED  
7/16" X 3/4" Shackle  
MD54725L0 PADLOCK LESS KIK NKR SHROUDED  
7/16" X 3/4" Shackle

**PADLOCK PARTS**

MDCP-011011-060	PADLOCK CYLINDER SET SCREW 50-Series	MDCP-142033	SHACKLE ASSY 1-3/4" CL 3/8" DIA HS 50-Series
MDCP-013107-020	PADLOCK ACTUATOR RET SCREW 50-Series	MDCP-142043	SHACKLE ASSY 2-1/4" CL 3/8" DIA HS 50-Series
MDCP-030430	PADLOCK SHACKLE SPRING 50-Series	MDCP-160691	G8R CYLINDER SPACER 52-Series
MDCP-100211	PADLOCK ACTUATOR NKR 50-Series	MDCP-170250	PADLOCK RUBBER CASE COVER 50-Series
MDCP-100221	PADLOCK ACTUATOR KR 50-Series	MDCP-200720	PADLOCK ACTUATOR KR 54-Series
MDCP-130510	PADLOCK ACTUATOR NKR 54-Series	MDCP-250030	BALL PADLOCK .187 DIA Cylinder Retaining
MDCP-142013	SHACKLE ASSY 7/8" CL 3/8" DIA HS 50-Series	MDCP-250040	BALL PADLOCK .312 DIA Cylinder Retaining
MDCP-142023	SHACKLE ASSY 1-1/8" CL 3/8" DIA HS 50-Series		

**PADLOCK CYLINDERS**

**HOCKEY PUCK 52-SERIES**

MD2001600 5 PIN HOCKEY PUCK  
Kik Cylinder

**BRASS BODY 50-SERIES**

MD320202 6 PIN LFRC PADLOCK  
Removable Core

**SYSTEM SERIES 54-SERIES**

MD510600 6 PIN 54-SERIES PADLOCK  
Kik Cylinder

**G8R 52-SERIES**

MD960357T 5 PIN G8R NKR PADLOCK CYLINDER  
MD960358T 5 PIN G8R KR PADLOCK CYLINDER



**CAM LOCKS**

**CAM LOCK PARTS & ACCESSORIES**

MD600350T-KIT 5 PIN 7/8" CAM LOCK KIT  
 MD600650T-KIT 5 PIN 1-1/8" CAM LOCK KIT  
 MD601150T-KIT 5 PIN 5/8" CAM LOCK KIT  
 MD601250T-239 3 PIN 7/16" CAM LOCK 2 FLAT  
 1 Keypull CCW 90 Deg

MD601251T-239 3 PIN 5/8" CAM LOCK 2 FLAT  
 1 Keypull CCW 90 Deg  
 MD601450T-KIT 5 PIN 1-1/2" CAM LOCK KIT

**CAM LOCK PARTS & ACCESSORIES**

MD96-0335 CAM LOCK EXTENSION 5/8"  
 MDCT-A01 CAM 3/4" FLAT Vertical Tenon  
 MDCT-A04 CAM 1-1/8" FLAT Vertical Tenon  
 MDCT-A05 CAM 1-1/4" FLAT Vertical Tenon  
 MDCT-A11 CAM 2" FLAT Vertical Tenon  
 MDCT-A19 CAM 3" FLAT Vertical Tenon  
 MDCT-D01 CAM 3/4" FLAT Horizontal Tenon  
 MDCT-D03 CAM 1" FLAT Horizontal Tenon  
 MDCT-D04 CAM 1-1/8" FLAT Horizontal Tenon  
 MDCT-D05 CAM 1-1/4" FLAT Horizontal Tenon  
 MDCT-D11 CAM 2" FLAT Horizontal Tenon  
 MDCT-D19 CAM 3" FLAT Horizontal Tenon  
 MDCT-H07 CAM 1-1/8" OFFSET 7/32" Vertical Tenon  
 MDCT-H09 CAM 1-1/8" OFFSET 1/8" Vertical Tenon  
 MDCT-H16 CAM 1-1/8" OFFSET 5/16" Vertical Tenon  
 MDCT-J01 CAM 1-1/8" OFFSET 7/32" Horizontal Tenon  
 MDCT-J06 CAM 1-1/8" OFFSET 1/8" Horizontal Tenon

MDCT-J13 CAM 1-1/8" OFFSET 5/16" Horizontal Tenon  
 MDCP-040010 CAM LOCK CAM LOCK WASHER Int Tooth  
 MDCP-040020 CAM LOCK SHELL LOCK WASHER Int Tooth  
 MDCP-040451 CAM STOP WASHER 90 DEGREE  
 MDCP-040461 CAM STOP WASH 180 DEGREE  
 MDCP-040500 CAM LOCK SPUR WASHER FOR MOUNTING  
 MDCP-040520 CAM LOCK ANCHOR WASHER  
 MDCP-050010 CAMLOCK CAM NUT  
 HXNUT 9/32-28UNS X 5/32  
 MDCP-050060 CAMLOCK MOUNTING NUT  
 HXNUT 3/4-27UNS X 5/32  
 MDCP-070181 CAM LOCK SECURITY COLLAR  
 MDCP-160051 1/8" CAM LOCK SPACER RING  
 MDCP-160071 3/16" CAM LOCK SPACER RING  
 MDCP-160081 1/4" CAM LOCK SPACER RING  
 MDCP-160301 3/8" CAM LOCK SPACER RING  
 MDCP-160551 1/16" CAM LOCK SPACER RING

**MISCELLANEOUS 60-SERIES**

**PLUNGER LOCKS**

MD6221557T 5 PIN PLUNGER LOCK

**SHOWCASE LOCKS**

MD6231550T 4 PIN SHOWCASE LOCK

**POP-OUT T-HANDLE CYLINDERS**

MD640150T 5 PIN POP-OUT T-HANDLE CYLINDER  
 MD640155T 5 PIN POP-OUT T-HANDLE CYLINDER  
 MD640950T 4 PIN POP-OUT T-HANDLE CYLINDER

**REMOVABLE PLUG LOCKS**

MD640250T 5 PIN 3/4" REMOVABLE PLUG LOCK  
 MD640550T 5 PIN 1-1/8" REMOVABLE PLUG LOCK

**REMOVABLE PLUG LOCK PARTS - PLUGS**

MD66024413 - PLUG FOR REMOVABLE PLUG LOCK  
 MD66024556 W PLUG FOR REMOVABLE PLUG LOCK  
 MD6602498 T PLUG FOR REMOVABLE PLUG LOCK

**COMPONENTS**

MD67029002-211-26 SHELL FOR REMOVABLE PLUG LOCK  
 MDCP-050110 REMOVABLE PLUG LOCK MOUNT NUT

**MICRO SWITCH LOCKS**

MD652150T-011 SWITCH LOCK MAINTAINED  
 MD652150T-012 SWITCH LOCK MAINTAINED  
 MD652150T-021 SWITCH LOCK MOMENTARY  
 MD652650T-101 SWITCH LOCK MAINTAINED  
 MD652650T-102 SWITCH LOCK MAINTAINED  
 MD652650T-111 SWITCH LOCK MOMENTARY  
 MD652650T-131 SWITCH LOCK MAINTAINED  
 MD652650T-132 SWITCH LOCK MAINTAINED  
 MD652650T-133 SWITCH LOCK MAINTAINED

**MICRO SWITCH LOCK PARTS**

MD65-0003 SWITCH LOCK SLEEVE KIT  
 MDCP-270511 WIRE LEAD ASSEMBLY 4"  
 MDCP-021171 PLUG RETAINER SWITCHLOCK  
 MDCP-030033 MOMENTARY CONTACT SPRING  
 MDCP-030530 ACTIVATOR SPRING  
 MDCP-040641 SWITCH LOCK STOP WASHER  
 MDCP-040741 SWITCH LOCK STOP WASHER

**XT INTELLIGENT KEY SYSTEM**

**XT MORTISE CYLINDERS**

MD100500 G XT 1-1/4" MORTISE CYLINDER  
MD105100 G XT 1-3/8" MORTISE CYLINDER

**XT RIM CYLINDERS**

MD100400H G XT 1-1/8" RIM CYLINDER

**XT KIK / KIL CYLINDERS**

MD2020049 G XT COR/RUS CL3100  
MD2020073 G XT COR/RUS 800, CL3300-CL3600  
MD2020051 G XT SCHLAGE A, AL, C, D, ND

**XT DUAL TECH CYLINDERS**

MD490423 G XT DUAL TECH CYLINDER

**XT DUAL TECH CAMS**

MDCP-100771-Z00 DUAL TECH DIRECT DRIVE CAM  
MDCP-100771-Z01 DUAL TECH DIRECT DRIVE CAM  
MDCP-100771-Z02 DUAL TECH DIRECT DRIVE CAM  
MDCP-100771-Z20 DUAL TECH DIRECT DRIVE CAM  
MDCP-100771-Z34 DUAL TECH DIRECT DRIVE CAM  
MDCP-100781-Z00 DUAL TECH OVER RIDE CAM  
MDCP-100781-Z01 DUAL TECH OVER RIDE CAM  
MDCP-100781-Z02 DUAL TECH OVER RIDE CAM  
MDCP-100781-Z20 DUAL TECH OVER RIDE CAM  
MDCP-100781-Z34 DUAL TECH OVER RIDE CAM

**XT PADLOCK CYLINDERS**

MD510600 G XT 54-SERIES PADLOCK

**XT SFIC CORES**

MDEA-100108 XT SFIC CYLINDER

**XT PADLOCKS**

MD5293000 G XT HOCKEY PUCK PADLOCK

**XT CAMLOCKS**

MDEN-150002-239 XT 7/8" CAM LOCK ASSEMBLY  
MDEN-150003-239 XT 1-1/8" CAM LOCK ASSEMBLY

**XT POP-OUT T-HANDLE CYLINDERS**

MDEV-8501D XT POP-OUT CYLINDER DEADBOLT  
MDEV-8501S XT POP-OUT CYLINDER SPRINGBOLT

**XT KEYS & KEY BUNDLES**

MD94-0239 XT INDUSTRIAL KEY (G2) & CHARGER  
MDEA-100107 XT INDUSTRIAL KEY (G2)  
MDEA-100110 XT INDUSTRIAL KEY (G2) DEMO/INST CTRL  
MDEA-100111 XT INDUSTRIAL KEY (G2) DEMO/INST  
MD94-0271 XT SLIM LINE KEY (G2) & CHARGER  
MDEA-100156 XT SLIM LINE KEY (G2) BASIC  
MDEA-100173 XT SLIM LINE KEY (G2) DEMO/INST  
MDEA-100174 XT SLIM LINE KEY (G2) DEMO/INST CTRL  
MD94-0307 XT SLIM LINE KEY (G3S) & CHARGER  
MDEA-100178 XT SLIM LINE KEY (G3S) PLUS  
MDEA-100177 XT SLIM LINE KEY (G3B) BLUETOOTH

**XT PROGRAMMERS, KITS & ACCESSORIES**

MDEA-100109 XT USB PROGRAM STATION ONLY  
MDEA-100138 XT MULTICHARGER  
MDEA-100088 XT PORTABLE KEY CHARGING  
MDEA-200056 XT USB WALL POWER SUPPLY  
MDEA-200057 XT VEHICLE POWER SUPPLY  
MDEA-200058 XT USB 2.0 CABLE  
MD94-0261 XT SMART SFIC SOLUTIONS

**T21**

Medeco® T21 is a sophisticated stand-alone key management system which combines innovative RFID technology and robust design to provide small to medium sized businesses with the advanced management of 21 keys or keysets in a plug and play solution.

**Features:**

- Stand-alone Plug & Play solution with advanced RFID technology
- Touchscreen interface
- PIN access to designated keys or keysets which are individually locked in place
- Keys are securely attached using special security seals
- Simple to configure through the setup wizard
- Concealed robust fixing points allow secure wall fixing
- Mains operated with optional battery backup

**iFOB**  
MDEA-100149



**BATTERY**  
MDEA-100154  
**SECURITY SEAL**  
MDEA-100148

**T21 KEY MANAGEMENT SYSTEM**

MDEA-100117 T21 KEY MANAGEMENT SYSTEM  
MDEA-100148 T21 SECURITY SEAL  
MDEA-100149 T21 iFOB  
MDEA-100154 T21 BATTERY



**T21**  
MDEA-100117



**MISCELLANEOUS PARTS**

MD94-0010	MORTISE CYLINDER JUMBO ADAPTOR	MDCP-064231	X4 LOCKING PIN
MD94-0174	MEDECO 3 SLIDER PACKAGE	MDCP-083551	BILEVEL SIDEBAR ASSEMBLY
MD94-0227	BILEVEL SLIDER PACKAGE	MDCP-084591	MEDECO 3 SLIDER
MDCP-030018	MEDECO 3 SIDEBAR SPRING	MDCP-084671	6-PIN SIDEBAR ASSEMBLY
MDCP-030910	MEDECO 3 SLIDER SPRING	MDCP-090881	SPRING BOLT FOR CABINET LOCK
MDCP-031170	X4 LOCKING PIN SPRING	MDCP-180011	CRESCENT STEEL INSERT
MDCP-031180	X4 SLIDER SPRING	MDCP-180021	RAISED ESCUTCHEON PLATE
MDCP-031210	COMPRESSION SPRING	MDCP-180041	FLAT ESCUTCHEON PLATE
MDCP-031230	PLUNGER LOCK BOLT SPRING	MDCP-182980	ADAPTOR PLATE
MDCP-031240	PLUNGER LOCK EJECTOR SPRING		

**PIN KITS, PINS, SPRINGS, COVER STRIPS & SET SCREWS**

MDCP-011011-020	SET SCREW FOR NON-I/C KEYMARK #6-32 X 1/8" Allen Cone	MDKW5006	PIN KIT BIA M3 50-SERIES METAL BOX
MDCP-011013-020	SET SCREW FOR HIGH SECURITY #8-32 X 1/8" Allen Cone	MDKW5010	PIN KIT BIA M3 53-SERIES PLASTIC BOX
MDCP-030001	TUMBLER SPRING STANDARD	MDKW5011	PIN KIT BIA M3 53-SERIES METAL BOX
MDCP-030017	TUMBLER SPRING CAM/SWITCH	MDTP-F10-XX	ORIGINAL BOTTOM PIN 100/PKG
MDCP-030042	TUMBLER SPRING REM CORE	MDTP-F10-XW	ORIGINAL MASTER WAFER 100/PKG
MDCP-030590	TUMBLER SPRING KEYMARK	MDTP-F10-XT	STANDARD DRIVER 100/PKG
MDCP-170011	6 PIN COVER BRASS LFIC	MDTP-F10-3M	MUSHROOM DRIVER 100/PKG
MDCP-170021	5 PIN COVER BRASS LFIC	MDTP-F10-BT	OLD STYLE #1 DRIVER .330
MDCP-170041	4 PIN COVER BRASS CAM AND	MDTP-F10-CT	OLD STYLE #2 DRIVER .300
MDCP-170051	6 PIN COVER SST OLD STYLE	MDTP-F10-DT	SPEC DRIVER .240
MDCP-170061	5 PIN COVER SST OLD STYLE	MDTP-F10-GT	SPEC DRIVER #5 BIA X .180
MDCP-170271	6 PIN COVER BRASS LFRC 100/PKG	MDTP-F10-HT	SPEC DRIVER #3 BIA X&ORIG .210
MDCP-170430	KEYMARK SFIC SPRING CAPS	MDTP-F10-JT	SPEC DRIVER #5 ORIG .150
MDCP-170440	KEYMARK SFIC SPRING CAPS	MDTP-F10-X	BILEVEL BOTTOM PIN 100/PKG
MDCP-170481	6 PIN COVER BRASS LFIC 100/PKG	MDTP-F15-X	BILEVEL TOP PIN 100/PKG
MDCP-170730-5	5 PIN COVER 20 SERIES KIK	MDTP-F15-XT	BIA M3 BOT PIN MILLED 100/PKG
MDCP-170730-6	6 PIN COVER 20 SERIES KIK	MDTP-F50-XX	BIA M3 MASTER WAFER 100/PKG
MDCP-170730-7	7 PIN COVER	MDTP-F50-XW	BIA M3 BOT PIN BROACHED 100/PKG
MDK-1001	PIN KIT ORIGINAL PLASTIC BOX	MDTP-F53-XX	ORIGINAL 60-SERIES PIN 100/PKG
MDK-1003	PIN KIT ORIGINAL PLASTIC BOX	MDTP-F60-XX	BIA M3 60-SERIES PIN 100/PKG
MDK-4001	PIN KIT KM & X4 SFIC WOOD BOX	MDTP-F90-XX	BIA M3 60-SERIES MASTER PIN
MDK-4002	PIN KIT KM & X4 SFIC METAL BOX	MDTP-F90-XX-XX	ORIGINAL BOTTOM PIN 100/PKG
MDK-4006	PIN KIT X4 CONV METAL BOX	MDTP-H10-XX	ORIGINAL MASTER WAFER 100/PKG
MDKJ1501	PIN KIT M3 BILEVEL METAL BOX	MDTP-H10-XW	ORIGINAL BOTTOM PIN 100/PKG
		MDTP-K40-XX-BH	ORIGINAL MASTER WAFER 100/PKG
		MDTP-K40-XX-TH	KM&X4 SFIC BOTTOM PINS 100/PKG
		MDTP-K43-XX-BH	KM&X4 SFIC BOTTOM PINS 100/PKG
			X4 CONV BOTTOM PINS 100/PKG

**TOOLS, FIXTURES, SALES KITS & KEY MACHINE COMPONENTS**

MD90-0001	SPANNER WRENCH FOR RIM	MDCP-282430	5 PIN STAKING TOOL 60 CAM
MD94-0032	BIAXIAL KEY GAUGE	MDCP-282451	HOLDING BLOCK ASSEMBLY
MD94-0204	MEDECO 3 DISPLAY KIT	MDCP-282500	X4 IC PINNING BLOCK 6-7P
MD94-0207	SPRING COVER INSTALL TOOL	MDCP-282530	SFIC PIN EJECTOR
MD94-0269	KEYMARK X4 DISPLAY KIT	MDCP-282540	SFIC HAND CAPPING PUNCH
MD95-100400	CUTTER FOR HIGH SECURITY	MDCP-286350	X4 KEY DECODER
MD95-102871	MEDECO 3 KEY CLAMP CONVERSION	MDT-7155	SWITCH LOCK TOOL
MDCB-CODE-BIA	BIAXIAL & MEDECO 3 CODE BOOK	MDPX-KYLUBE-02	FLUID FILM 2.25 OZ SPRAY
MDCB-CODE-BOK	ORIGINAL CODE BOOK	MDPX-KYLUBE-11	FLUID FILM 11.75 OZ SPRAY
MDCP-011513-160	HOLDING BLOCK LOCKING SCREW		



**MORTISE CAMS & KNOB CYLINDER TAILPIECE DRAWINGS**

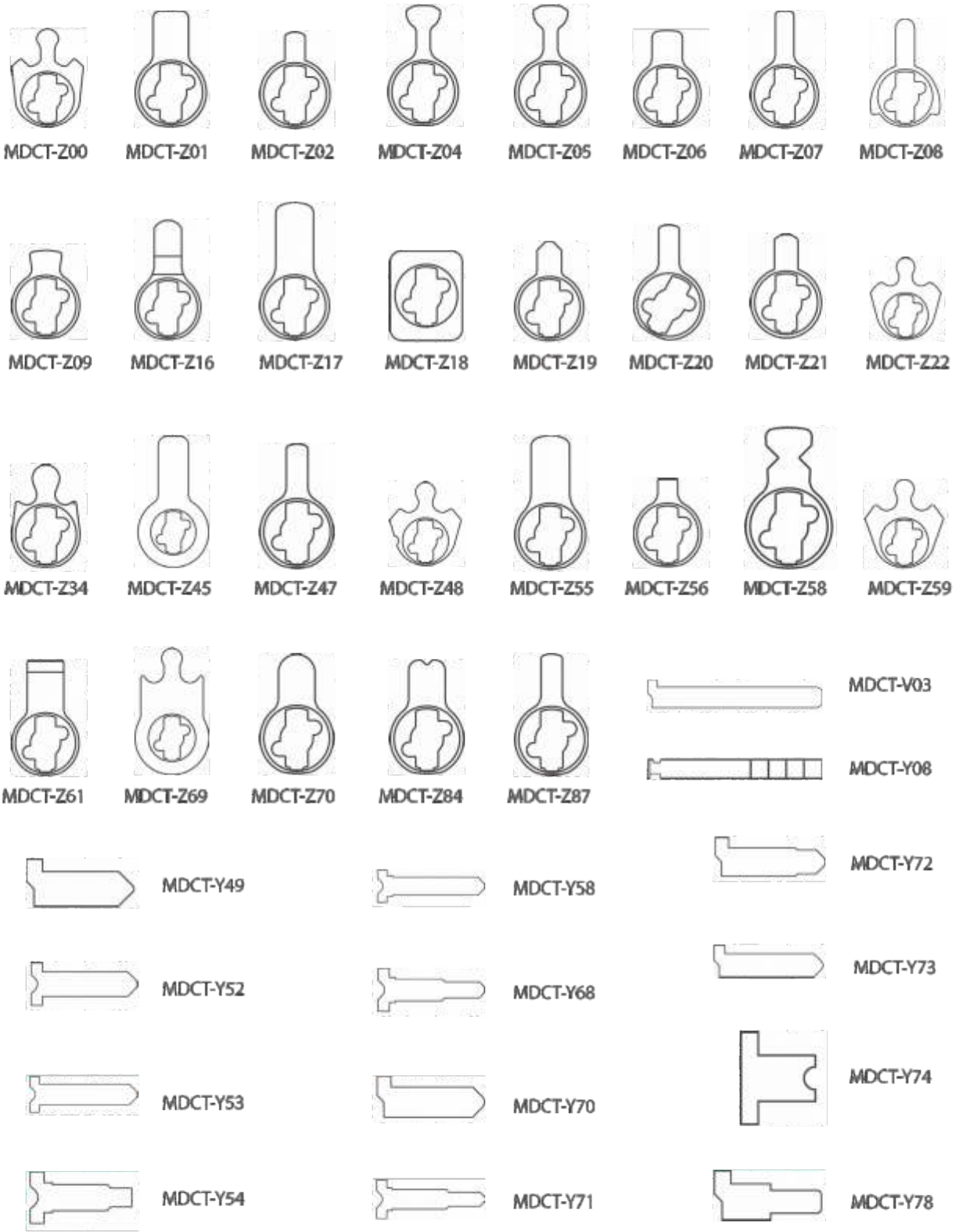

SCREWDRIVERS

MEGAPRO® 15-in-1

Megapro® Professional Quality Products

Megapro® pull-out bit cartridge screwdrivers - superior performance, award-winning design, and outstanding convenience are what set these unique Megapro multi-bit screwdrivers apart from ordinary multi-bit screwdrivers. Tradesmen value the pull-out bit cartridge that organizes and hold the bits securely in place. It's fast and easy to select any one of the 14 screwdriver bits.

Professional quality high carbon steel shaft and a tough TRIAX® nylon reinforced handle assure lifetime

performance against defects in workmanship and quality. The convenient pull-out bit cartridge is easy to customize with any screwdriver bit load to meet your individual needs.

The end of the shaft serves as a 1/4" hex nut driver. Other features include the PALM SAVER™ cap, EZ GUIDE™ collar, professional quality S2 steel bits and a comfortable, non-slip grip.



Megapro® Original

Every Megapro® 15-in-1 screwdriver comes with seven double-ended bits or 14 different sizes of screwdriver bits in the most common bit types. Shaft opening is 1/4" nut driver.

Megapro® Tamperproof

The 15-in-1 Tamperproof comes loaded with the most common security bits, including: Spanner, Hex pin and Star pin.

Select any bit, any size:

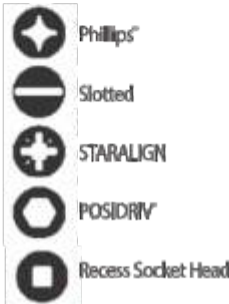

Part Number	Description
<b>Megapro® Multi-Bit Screwdrivers</b>	
MP151NAS	15-in-1 Screwdriver
MP151TP	15-in-1 Tamper Proof
<b>Megapro® Double Ended Replacement Bits</b>	
MPFD4-6	Standard Slotted Bit
MPHDT1/8-9/64	Tamperproof Hex-hole Bit
MPHDT5/32-3/16	Tamperproof Hex-hole Bit
MPPD0-3	Standard Phillips Bit
MPPD1-2	Standard Phillips Bit
MPSTD10-12	Tamperproof Spanner Bit
MPSTD6-8	Tamperproof Spanner Bit
MPTDT10-15	Tamperproof Star-hole Bit
MPTDT20-25	Tamperproof Star-hole Bit
MPTDT27-30	Tamperproof Star-hole Bit
MPTD10-15	Standard Star Bit
MPTD20-25	Standard Star Bit
MPTD27-30	Standard Star Bit

Select any bit, any size:

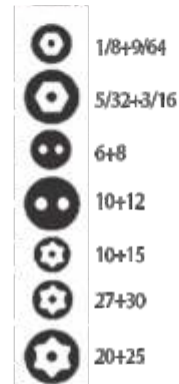

## CLEARPATH

### 59J Series Vestibule



#### MSCTP-HSSV

Contains: (2) 59-HSS Switches, (2) CP/STX Sequencing Transmitters & Surface Mounting Boxes, (1) 59V-HSS, (1) CP/TX-V Dual Transmitter & Surface Mounting Box, (2) CP/RX receivers)

Contains: (2) 59R4-HSS switches, (2) CP/TX-R4

### 59R4 Series Package



#### MSCTP-R4-HSS

transmitters & surface mounting boxes, (1) CP/RX receiver)

### 59 Series Package



#### MSCTP-HSS

Contains: (2) 59HSS switches, (2) CP/TX transmitters & surface mounting boxes, (1) CP/RX receiver)

### Stainless steel with etched and paint filled legends and stainless steel back plate



**MS59J-HSS** 1½" x 4¼"



**MS59R4-HSS** 4 ½"



**MS59-HSS** 4 ½"

### Exterior grade polycarbonate surface mounting boxes



**MS1010**



**MS1025**



**MS1020**

### 59, 59J & 59R4 Series Transmitters

MSCP/TX-J    MSCP/TX-R4    MSCP/TX

- Prewired and installed with battery in a surface mount box
- Three different frequencies
- Push Plate Switches NOT included

### ClearPath Receiver



MSCP/RX

- 3 selectable frequencies
- Timer used to activate automatic doors and directly release electric locking devices

Plug-In Module for dual receiver mode or two sequenced output (with delay of up to 20 seconds) mode.

MSRXM

## Nicholson®

## NICHOLSON

### FILES

#### Nicholson 6" Round File, Cut No. 2 (Swiss Pattern)



Round Files taper throughout their length to a fine point. Double-cut.

NI40663

#### Nicholson 6" Pippin File, Cut No. 2 (Swiss Pattern)



Pippin Files, sometimes called "Apple Seed" Files, have rounded backs which taper to a sharp edge. They also taper to a point in both width and thickness.

NI40506

#### Nicholson 4", 6", and 8" Warding Bastard Cut



Warding Files are rectangular in section and used principally by locksmiths in repairing or filing ward notches in keys. Also suited for use in narrow spaces where other files will not fit. All double cut on sides, single cut on edges.

NI16507 4"  
NI16663 6"  
NI16761 8"



# REGENERATIVE POWER DOOR OPERATOR

FOR MODERATE TO HIGH-TRAFFIC APPLICATIONS

**Norton®**

**ASSA ABLOY**

ASSA ABLOY, the global leader  
in door opening solutions



## 5800 SERIES ADAEZ®

- » Regenerative power system
- » Certified to reduce energy consumption
- » Easily installs with wire-free or plug-in versions
- » Push and pull side mounting
- » Shock absorbing arm

Contact your local Hardware Distributor to purchase today:

**NortonDoorControls.com/sales**

**160 SERIES**

The 160 features an adjustable spring, tri-packed, nonhold open arms and Independent and separate latch, sweep and backcheck intensity valves.

**Features:**

- Two models:
  - 161BF: adjustable spring size 1 through 4
  - 164: size 4 spring
- Non-handed
- Cast aluminum body
- Back-and-pinion design
- Independent latch sweep and backcheck intensity valves

- Non-hold open arms
- Closer footprint: 3/4" x 9 1/8"
- Closer projection: 2 3/8"
- Available in 689 (aluminum) or 690 (dark bronze)
- ANSI/BHMA A156.4, Grade 1
- UL and cUL listed, includes compliance to UL 10C
- Meets requirements for for Americans with Disabilities Act (ADA) and ANSI/BHMA A117.1
- 5-year limited warranty

- NO161BF-TPN-689
- NO161BF-TPN-690
- NO164-TPN-689
- NO164-TPN-690

- Adjustable Size 1-4 Door Closer Aluminum
- Adjustable Size 1-4 Door Closer Bronze
- Size 4 Door Closer Aluminum
- Size 4 Door Closer Bronze

Featuring easy installation and maintenance and dependable control, the 160 is perfect for office doors, utility doors and strip mall applications.

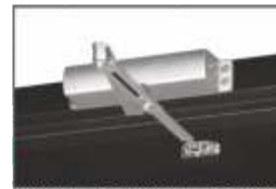

**WIRE FREE DOOR OPENER**

**Auto Door Opener with 2 Wireless Transmitters**

**Features:**

- An extreme duty, low energy opener designed for institutional, high traffic manual opening applications that occasionally require automatic operation
- Charges an onboard battery pack eliminating the need for electrical power
- For doors up to 48" wide and 250lbs. Included are two wireless push button transmitters

**Parts**

- NOADA1012-2 Push Button Assy w/RF 1 3/4" PBNR-RF
- NOADA1023 External Battery Charger Kit
- NOADA1007P Battery Assembly ADAEZ Pro
- NOADA1004 Operator Cover Alum (628)
- NOADA1031 Hand Held RF Transmitter



- NO5833-NPB-693T
- NO5845-NPB-693T

**POWER OPERATOR**

5740-689



5740-690



**Power Operator**

- NO5740-689 Power Operator Push or Pull Closer Sizes 1-6 Aluminum
- NO5740-690 Power Operator Push or Pull Closer Sizes 1-6 Dark Bronze



**1600BC/1601 SERIES**

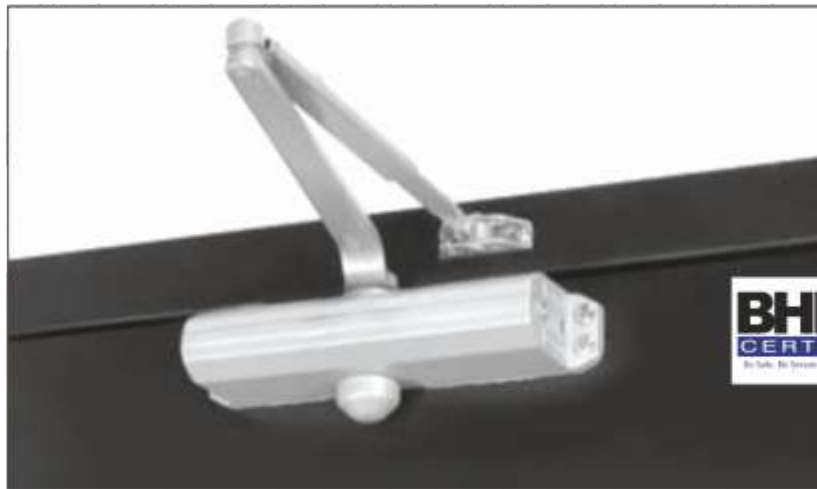

**1600BC Series**

**Features:**

- Non-handed
- Standard, separate and independent, latch, sweep and
- Staked valves

- 2 1/8" (73mm) projection
- All standard arm applications allow doors to swing 180°, conditions
- d backcheck cushioning valves permitting
- 10-year warranty

**Arm Dimensions**

**Regular Arm** This is the only pull-side application where a double lever arm is used. It is the most power-efficient application for a door closer. Since the arm assembly projects directly out from the frame, this application may present an aesthetics issue or be prone to vandalism. Sufficient frame, door and/or ceiling clearance must be considered.

**Installs 3-Ways** - regular arm, parallel arm and top jamb from standard carton.

**Non-Handed** - can be installed on doors of either hand.

**Independent Adjustable Sweep Speed.**

**Independent Adjustable Latch Speed.**

**Adjustable Backcheck Standard Feature.**

**Hold-Open Arm** - available with 90° to 180° hold-oper; suffix "H" to the Catalog Number. □ For doors opening up to 100°. Mounting holes for closer body are spaced 3/4" vertically x 9 1/8" horizontally.

**1601/1601BF Series**

Door closers combine rugged durability, optimum control of swinging doors and a complete range of spring and power adjustment. Hydraulic control and spring power adjustments are easily made right at the door. Together these features help achieve the opening force requirements of the American with Disabilities Act (ADA), ANSI 117.1 National Handicapped Codes, as well as the industry's most demanding performance criteria, ANSI 156.4-Grade 1.

Non-critical, independent valves allow precision adjustment of sweep speed, latching speed, delayed action or back check.

The same "easy turn" hex key adjustment allows you to increase or decrease the spring power to suit the opening.

**Features:**

- **Multi-Size Power:** The closer spring assembly can be adjusted through a wide power range. An adjustment shaft accepts a 3/16" Hex wrench.
- **Two Power Ranges:** Each series can be adjusted through a range of sizes: Series 1601 Normal Power Range Closers, sizes 3 thru 6. Series 1601BF Accessibility Code Closers, sizes 1 thru 4.
- **Non-Handed:** Installed on either right or left hand doors for all applications.
- **Adjustable Sweep Speed:** An independent regulating valve, hex-key-operated, permits adjustment of the general closing speed.
- **Adjustable Latch Speed:** An independent regulating valve, hex-key-operated, permits adjustment of the door's speed for approximately the last 10° of the closing cycle.
- **Adjustable Backcheck Cushioning:** An independent regulating valve, hex-key-operated, provides an adjustable hydraulic cushion to the door opening speed toward the end of the opening cycle.

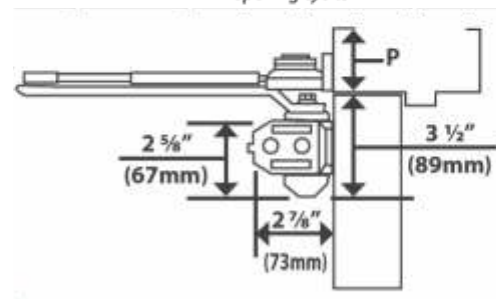
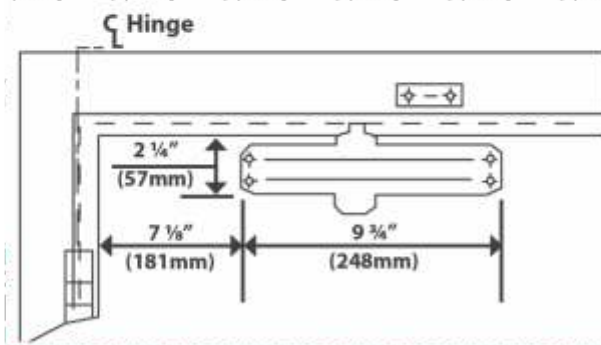



**1600BC/1601 SERIES — continued**

**Arm Dimensions**

**Top Jamb**

For efficiency reasons this application provides the best alternative to the regular arm application. There must be sufficient frame face and/or ceiling clearance for this application. It requires a top rail on the door of just 2 1/4". This application provides the best door control for doors in exterior walls that swing out of a building. The entire door closer and arm assembly project from the frame, similar to the regular arm application, where the matters of appearance and malicious abuse can be of concern. Consideration must be given to depth of the frame reveal.

**Parallel Arm**

This application provides the most appealing design appearance for a surface-mounted door closer having a double lever arm. This may also be beneficial in vandalism-prone areas. It is on the push side of the door and the arm assembly extends almost parallel to the door. In the closed position, there is very little or no hardware projecting beyond the frame face in most situations. Due to the geometry of the arm it is approximately 25% less power-efficient than a regular arm application. The entire closer and arm assembly are mounted below the frame stop, requiring a top rail clearance on the door of between 5 3/8".

**CloserPlus® Arm**

Similar to the Parallel Rigid arm, this arm incorporates a stop at the arm's soffit plate to dead stop the door at a predetermined degree of door swing between 85° and 110°, in 5° increments. Prior to dead stop the door closer's backcheck feature slows the door speed to reduce the impact of the stop action. CloserPlus Arm is intended for use where an auxiliary door stop cannot be utilized and no more than moderate abuse is anticipated. Available with or without hold open. (Hold open is adjustable)

**Finishes:**

- Aluminum 689
- Statuary Bronze 690

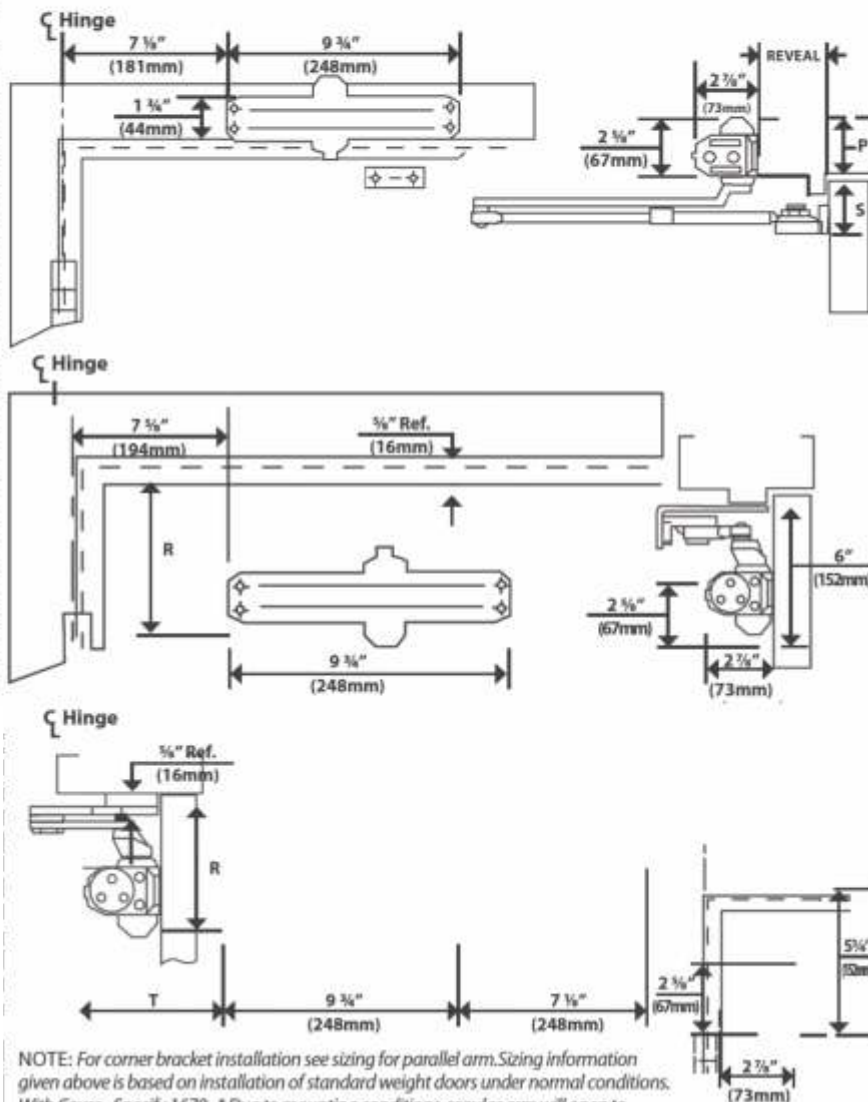

NOTE: For corner bracket installation see sizing for parallel arm. Sizing information given above is based on installation of standard weight doors under normal conditions. With Cover - Specify 1670. \* Due to mounting conditions, regular arm will open to approx. 150 degrees only - top jamb will open to 180.

**1600BC Series - Regular**

- NO1603BC-689 Size 3
- NO1604BC-689 Size 4
- NO1604BC-690 Size 4

**1600BC Series - Hold Open**

- NO1604BCH-689 Size 4 HO
- NO1604BCH-690 Size 4 HO

**1601 Series - Regular**

- NO1601-689 Size 3-6
  - NO1601-690 Size 3-6
  - NO1601H-689 Size 3-6
  - NO1601H-690 Size 3-6
  - NO5845-NPB-693T ADAEZ PRO
- COMPLETE PUSH/PULL**

Interior	Max. Door Size Wood or Metal		Norton Number of Closer Recommended			Dimensional Information					
	Exterior	In-Swing	Out-Swing	Reg. Arm	90° to 180° Fusible Link Holder Arm	For 1602-1606: Approximate Shipping Weight = 8					
						Standard Mount	P	T	U	V	W
2'-8"	2'-6"	2'-6"	2'-10"	1682		2 1/2"	5 1/2"	9 1/4"	1 1/4"	3 1/2"	
3'-2"	2'-6"	2'-10"		1683		2 1/2"	5 1/2"	9 1/4"	1 1/4"	3 1/2"	
4'-0"	3'-0"	3'-6"		1604	1604H	1604NFL	2 1/2"	5 1/2"	9 1/4"	1 1/4"	3 1/2"
4'-6"	3'-6"	4'-0"		1605			2 1/2"	5 1/2"	9 1/4"	1 1/4"	3 1/2"
5'-0"	4'-0"	4'-6"		1606			2 1/2"	5 1/2"	9 1/4"	1 1/4"	3 1/2"

**7500 SERIES**

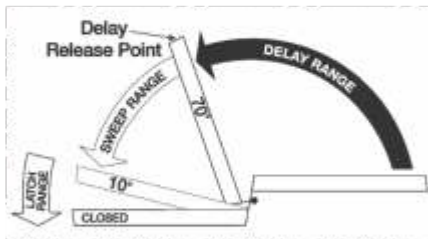

**Adjustable Delayed Action Closing**  
An optional hydraulic feature that adds a third speed range to the closing cycle. This feature becomes effective when the door is opened and released at any point beyond 70°. The amount of time delay depends upon the combination of the angle of door release and valve adjustment. The valve can be adjusted with a 1/8" (3mm) hex key from no delay time up to maximum delay times of: (see table to right)

Door Opened and Released at	Approximate Time of Delay Cycle
180°	4-5 minutes
120°	2-3 minutes
90°	25-30 seconds

**Finishes:**  
Aluminum 689  
Statuary Bronze 690

Power Adjustment Chart		
Maximum Interior Door Size Inches	Maximum Exterior Door Size Inches	Full Clockwise Turns of Closer Power Adjustment Nut (from "0" turns)
32	28	5
36	34	8 1/2
42	38	11
52	42	13 1/2
60	48	16 1/2
<b>NOTE:</b> Maximum of 16 1/2 turns (360°) of Power Adjustment Nut. Closer is shipped set at 8 turns from the factory.		

**Installed Regular Arm**

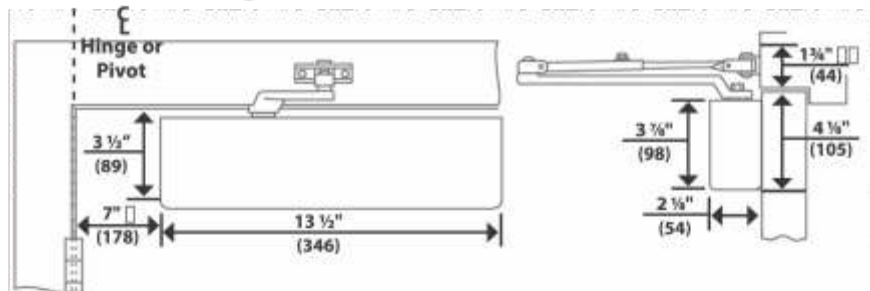

Mounting holes for closer body are spaced 2 3/8" (60mm) vertically x 6 3/4" (171mm) horizontally.  
□ For doors opening up to 100°  
□ This dimension will vary. Standard non-hold open arm illustrated.

Power Adjustment Chart		
Maximum Interior Door Size Inches	Maximum Exterior Door Size Inches	Full Clockwise Turns of Closer Power Adjustment Nut (from "0" turns)
32	28	5
36	34	8 1/2
42	38	11
52	42	13 1/2
60	48	16 1/2
<b>NOTE:</b> Maximum of 16 1/2 turns (360°) of Power Adjustment Nut. Closer is shipped set at 8 turns from the factory.		

**Installed Top Jamb Arm**

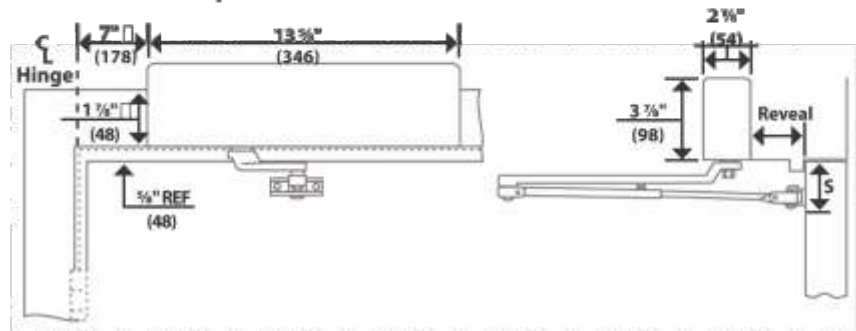

Mounting holes for closer body are spaced 2 3/8" (60mm) vertically x 6 3/4" (171mm) horizontally.  
□ For doors opening up to 100°  
□ Minimum frame face with 7786 drop plate. 3 1/4" (83mm) required when drop plate is not used.

Power Adjustment Chart		
Maximum Interior Door Size Inches	Maximum Exterior Door Size Inches	Full Clockwise Turns of Closer Power Adjustment Nut (from "0" turns)
30	26	7
34	30	9
38	36	12 1/2
48	42	14 1/2
54	48	16 1/2
<b>NOTE:</b> Maximum of 16 1/2 turns (360°) of Power Adjustment Nut. Closer is shipped set at 8 turns from the factory.		

**Installed Parallel Arm**

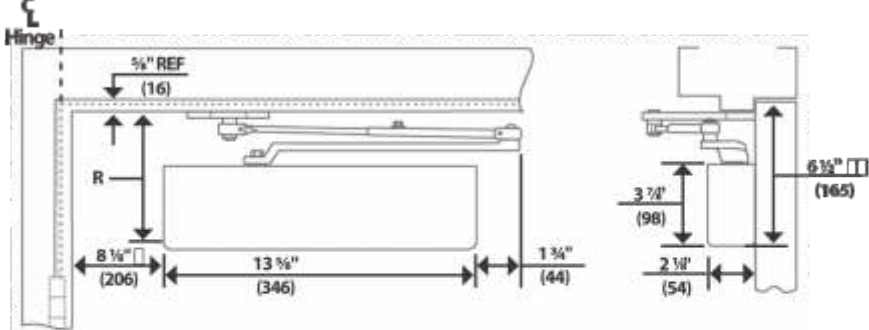

Mounting holes for closer body are spaced 2 3/8" (60mm) vertically x 6 3/4" (171mm) horizontally.  
□ For doors opening up to 100°  
□ This dimension will vary. Standard non-hold open arm illustrated.



**7500 SERIES — continued**

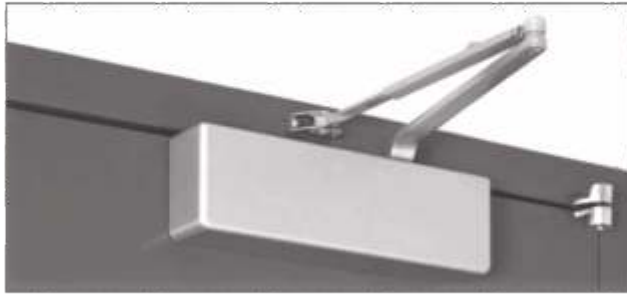

**Non-handed**

With few exceptions all series 7500 and series 7700 door closers are non-handed and can be installed on either right or left hand swing doors. Pinion shaft extends vertically through the closer body in both directions. This permits the closer to be positioned on either right or left hand doors for most applications.

**Sweep Speed Control Valve**

Allows adjustment of door speed from the doors full open position down to approximately 10° from the closed position.

**Latch Speed Control Valve**

Allows adjustment of door speed from approximately 10° down to the door's fully closed position.

**Adjustable Backcheck Cushion Valve**

Provides control of the door in the opening cycle, beginning at approximately 75° of door opening. It slows/cushions the door opening, when the door is forcibly opened beyond its pre-adjusted limits.

**Adjustable Backcheck Position Valve**

Allows the door opening position, where backcheck cushioning begins, to be adjusted to a greater door angle, up to a max of 20° farther (approximately 95°).

**Exploded View of Closer Body**  
(without delayed action)

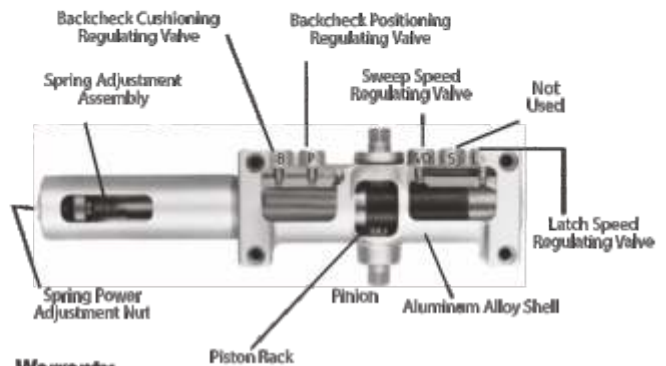

**Warranty**

These closers carry a limited ten-year warranty against defect, and life of the building on the aluminum housing.



**Installation Instructions**

NOTE: The closing force for series 7500 door closer is adjustable from a size 1-6, as outlined in ANSI Standard A156.4. When this series of door closer is installed and adjusted to conform to ADA reduced opening force requirements (5 lbs. max) for interior doors. It may not have adequate closing force to reliably close and latch the door. Power adjustment charts are on the next page, are recommended where possible to ensure proper door control.

NO7788-689	Drop Plate Wide
NO7788-690	Drop Plate Wide
NOCLP7500-689	CloserPlus Arm
NO7500-689	Door Closer Size 1-6
NO7500-690	Door Closer Size 1-6

**8000 SERIES**

NO8501-689  
Door Closer Size 2-6



**Features**

**Aluminum Alloy Housing:** Closer bodies are constructed of a special aluminum alloy, carefully selected to accommodate interactive steel components and operating conditions.

**Rack & Pinion Operation:** Provides a smooth constant control of the door through its full opening and closing cycle.

**Non-Handed:** With few exceptions the 8501 door closer are non-handed and can be installed on either right- or left-hand swing doors. Pinion shaft extends vertically through the closer to be positioned on either right or left hand doors for most applications.

**Tri-Style:** 8501 comes with screws, brackets and soffit plates to allow for regular, top jamb, and parallel arm installations.

NO8501-689	Door Closer
NO8501-690	Door Closer



**ACCESSORIES**

**Closer Mounting Plates**

**Narrow Top Rail - #1688 Drop Plate:**  
For use where a narrow top rail prevents the closer from being mounted directly to the door surface. This drop plate can be used to mount a closer on a top rail as narrow as 2 5/8" in height.

**Low Ceiling Clearance - #1687 Drop Plate:**  
For use where the ceiling clearance is between 1 3/4" and 2 1/8". This places the centerline of the arm mounting screws at 2 3/4" from the top of door.

**Finishes:**

Aluminum 689  
Statuary Bronze 690

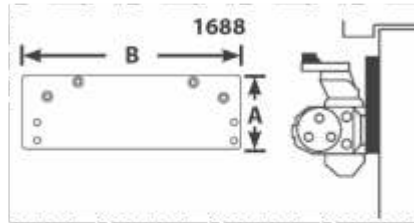

Plate No.	Dimensions	
	A (width)	B (length)
1688	3 1/4"	9 3/4"

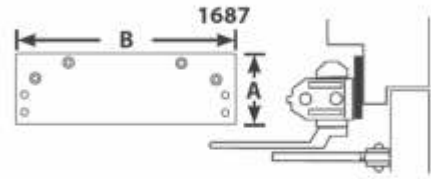
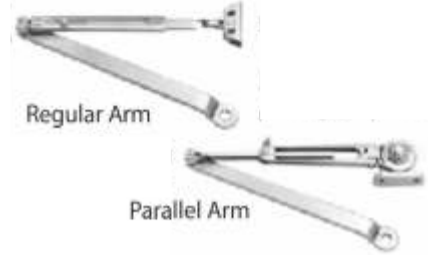
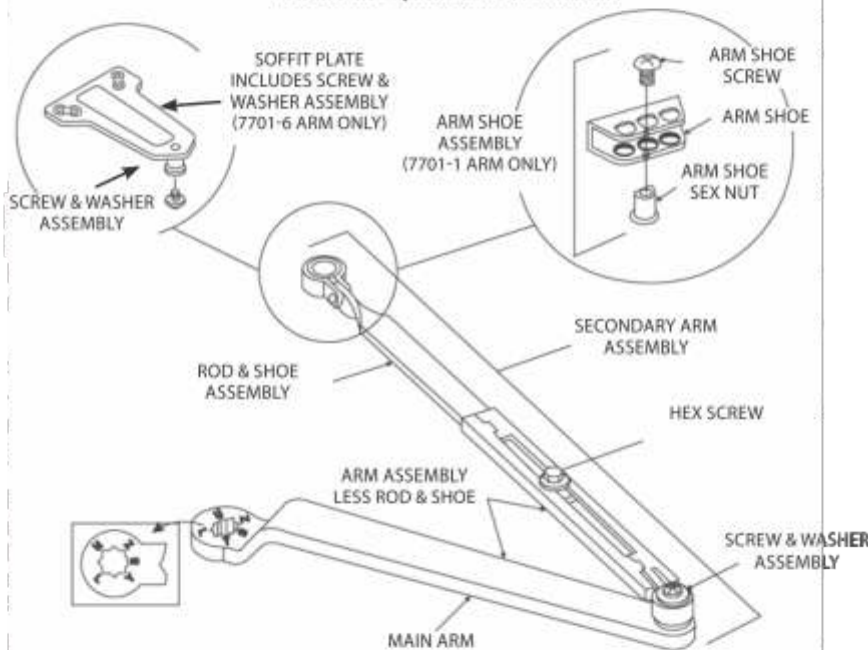

Plate No.	Dimensions	
	A (width)	B (length)
1687	2 1/8"	9 3/4"

NO1688-689 Drop Plate 1604/05/06BC  
NO1688-690 Drop Plate 1604/05/06BC

NO1687-689 Drop Plate 1604/05/06BC  
NO1687-690 Drop Plate 1604/05/06BC

**Non-hold Open Arm Assemblies**



**Arms**  
NO7701-1-689 Regular Arm  
NO7701-1-690 Regular Arm  
NO7701-8-689 Parallel HO Arm Complete

**Rod & Shoe**  
NO7701-11-689 Regular Arm Assy  
NO7701-11A-689 Long Arm Assy

**Soffit Plates**  
**Standard Installation - #1618A Soffit Plate:**  
This soffit plate is supplied standard with parallel arm closers. It can be mounted here the frame soffit is as narrow as 1".

NO1618A-689 NHO Standard

**Sexnuts / Bolts**  
1 3/4" Door - 1600 / 8000 Closers  
1600BC, 1600-3500, 8000-3500

NOSNB134-38-689 4/PKG  
NOSNB134-38-690 4/PKG

**Thrubolt / Grommet Nut**  
1 3/4" Door - 1600 / 8000 Closer

NOTBGN134-38-69 4/PKG

**Hinge or Pivot**

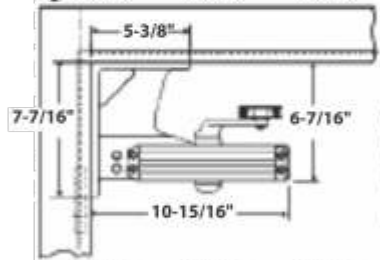

**Corner Brackets for Closer Mounting Opposite Hinge Side - #1647 Corner Bracket:** For use where it is desired to mount the closer regular arm on the opposite to hinge side of the door. Can also be used to clear an overhead door holder.

NO1647-689 UNIV 1600BC

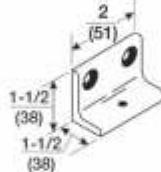

**Narrow Frame Support Bracket**

**For Series:**  
7700, 78BF & 8000.  
NO6890-689 Narrow Frame Support Bracket  
NO6890-690

**Blade Stop**

For use where the door frame has a blade stop and the soffit plate must be mounted on the frame rabbet.  
NO6891-689  
NO6891-690



**LOCKS — continued**

**T37 DRAWER LOCK**

T-Bolt Metal Drawer Lock Re-Keyable Pin Tumbler



- OLT37-26D-101
- OLT37-26D-CUST-KAX2
- OLT37-26D-CUST-KAX3
- OLT37-26D-CUST-KAX4
- OLT37-26D-KD

**SFIC FILE CABINET LOCK**



INCLUDES: Plastic actuator and red caution flag when unlocked, vertical slot, round spring bolt.  
TYPICAL USAGE: Metal file cabinet and medical cart.  
ACCEPTS: Best, Arrow, Falcon, or equivalent IC cores. Fits 6 or 7 pin cores.

OL724VR-26D



OL725RL-DR-LH-26D  
IC RIM LATCH LH DOOR  
IC CABINET LOCK L/CORE

**DCN CAM LOCK**

Compatible Keyway Re-Keyable Pin Tumbler

**MATERIAL:**  
Solid Brass Case - Brass Plug - Steel Cams

**FEATURES:**

- D4291: 4 Pin Tumbler / Re-Keyable to 5 Pin System
- Brass Pins - .101 Pins
- Cylinder Length: CN1/CR-1 1 1/8" - CN2/CR-2 1 3/8"
- Includes: Pronged Wood Washer, Trim Ring and 2 Straight Cams
- Locksmith Package includes: 6 cams: 2 straight, 2 inbent & 2 outbent.
- Material Thickness: 3/4" & 7/8"

**RE-KEYING INSTRUCTIONS**

1. Remove cam and screw.
2. Turn lock upside down.
3. Take sharp tool and push retainer staple out.
4. Quarter turn keyway and place follower tool into back of cylinder plug.
5. Push follower through lock removing plug for re-keying.

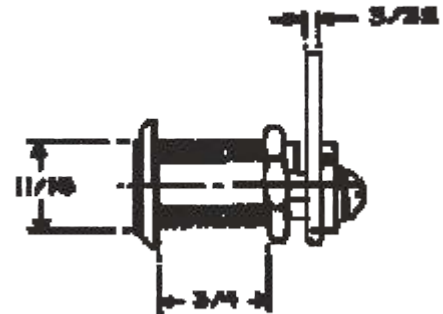

Key Section Ref. - NATL-D4291 lico-1069L

- OLDCN1-26D-KD
- OLDCN1-26D-915
- OLDCNP-100-LC 3" Cam
- OLDCNP-500-ARP Stabilizer Plate

**DCR CAM LOCK**



- OLDCR1-26D-4T2
- OLDCR2-26D-4T2

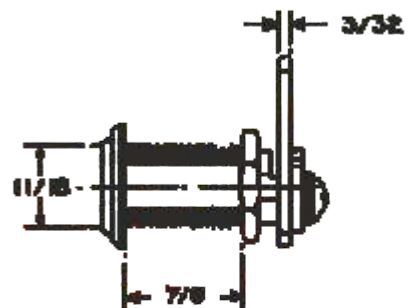

Key Section Ref. - CCL-8618C-R1 lico-1003A



**#721 IC CORE**

**RE-KEYING INSTRUCTIONS**

1. Remove set screw.
2. Quarter turn key and pull out cylinder and housing from lock body.
3. Extract cylinder and re-key same as a Schlage or Weiser style cylinder plug. Note: Olympus brass cylinder body will chamber Schlage & Weiser original plugs along with Lori and AWI replacement plugs.

4. Replace cylinder in housing. Note: For proper operation, lazy cam must be timed. Pointed section of cam must face away from side of lock body bolt projects from.
5. Insert cylinder and housing by aligning set screw and hole. Push until cylinder is approx. 1/8" from seated position. Use key to pick up lazy cam which will fully seat cylinder. Note: If key does not withdraw at end of bolt throw, cam is not timed right.

**CABINET DOOR / DRAWER LOCK - Interchangeable Core**

*Interchangeable Core/Accepts both 6 pin & 7 pin. Field reversible to fit both door & drawer applications. Includes: 3 spacers #DC78, 3 slotted strikes, 6 fixing screws and 1 extra driver pin. Standard Barrel: 1 1/4"*

**IC Core Cabinet Door Lock  
OL721DR-26D**

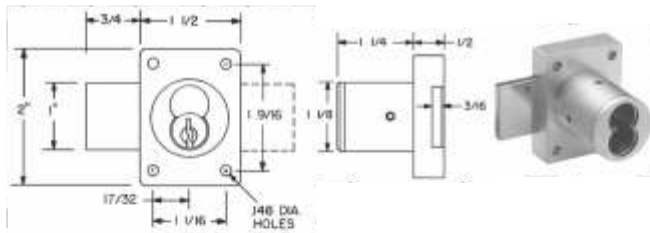

**IC Core Cabinet Drawer Lock  
OL721DW-26D**

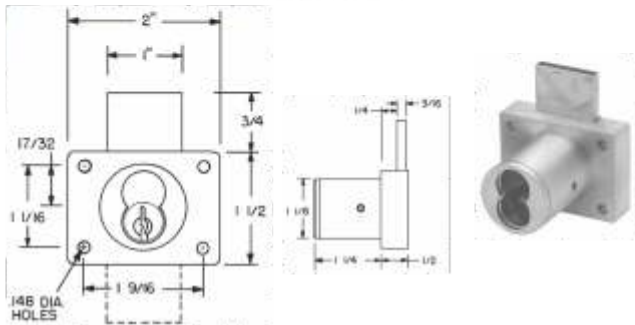

**IC Cam Lock 1 1/4" L/Core  
OL720LM/DM-26D**

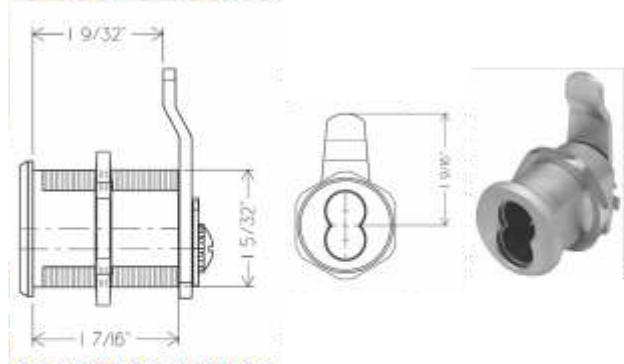

**IC Mortise Deadbolt VH Drawer  
H-26D**

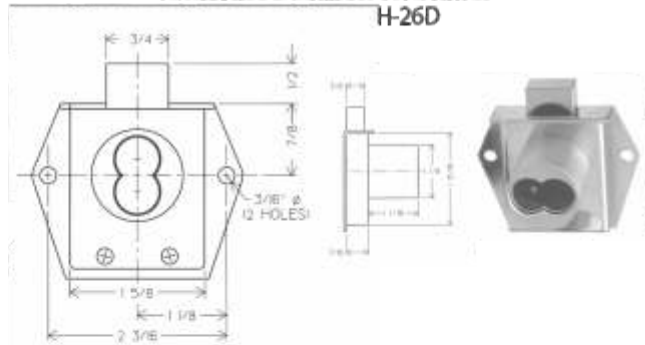

**IC Rim Deadbolt VH Drawer  
26D**

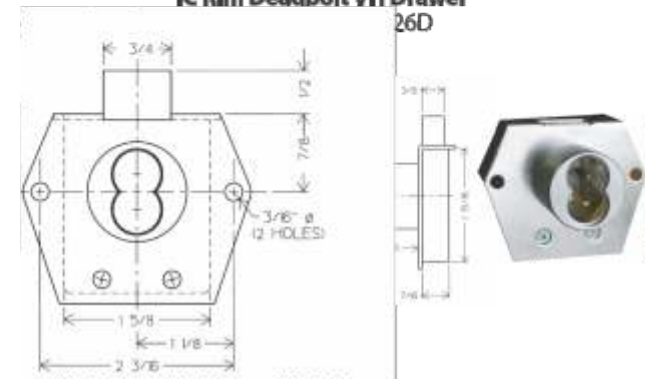

**IC Rim Latch Right Hand Door  
OL725RL/DR-DM-26D**

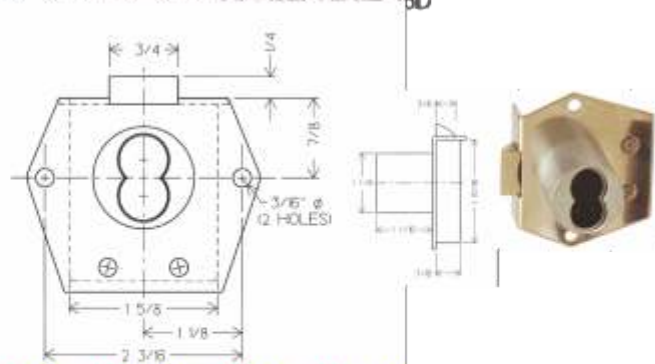

**#721 IC CORE (- Continued)**



**Door Lock Body Medeco/Yale IC**  
OL931DR-26D



**Drawer Lock Body Medeco/Yale IC**  
OL931DW-26D

**ACCESSORIES**

**STRIKES FOR CABINET LOCKS**



**OL12-1-26D**  
*Angle Strike*

**OL12-2-26D**  
*Heavy Duty Angle Strike*



**OL07S-26D**  
*Slotted Strike*

**OL10-054**  
*Bar Strike 1/4"*



**OL12-4-ZP**  
*Frameless Strike*

**OL10-055**  
*Bar Strike 1/2"*



**OLT54C-26D**  
*T-Knob Cylinder Replacement Kit*

*For C8154/C8155 Uncoded*



**Reinforcing Trim Spacer**

*For 1 1/8" Diameter Cabinet Locks*

**OLETS1-125-26D** *1/8" Large Pin Dia.*

**OLETS1-250-26D** *1/4" Large Pin Dia.*

**OLTR200A-32D** *Trim Collar Assmt. Pack (1/8", 1/4", 3/8")*

**Reinforcing Trim Spacer**

*For 1 1/8" Diameter Cabinet Locks*

**OLETS2-125-26D** *1/8" Large Pin Dia.*



**Template for Reinforcing Trim Spacer**

**OLETST1-26D**

*External metal 1/4" reinforcing trim spacer*

*Through-bolt mount*



**Spacers for Cabinet Locks**

**OLWP21** *Small Pin Diameter*

**OL10-350** *Large Pin Diameter*

**OL777IC-DRK-26D**

*Schlage Ic Door Lock*

**OLDCN1-26D-KA-51004**

*Cam Lock 1 1/8" National*

## WIRELESS ANNUNCIATOR SYSTEM

### OXRC-20U RECEIVER

*Features:*

- Receiver emits one tone to inform the user of the arrival of a visitor
- Accepts 3 transmitters, identifies each zone with different chime tone
- Operated by UL listed, 9VDC adaptor (included)
- Plugs into any standard electrical outlet (120V)



### OXTD-20U TRANSMITTER/SENSOR

*FEATURES:*

- Install at store/business entrances and wherever indoor detection coverage is desired
- Red LED low battery indicator
- Uses passive infrared to detect motion and send RF signals to receivers
- Weather proof housing (IP54 rating) for both indoor/outdoor use.
- Choose 50ft. Long Range or 15ft. Fan (Wide) detection pattern
- Operates on 9 volt battery





170

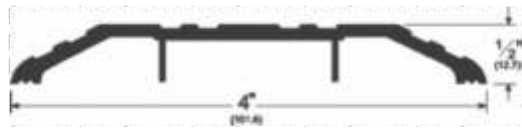

**Fluted Saddle Thresholds**

PE170A36  
PE170A42  
PE171A36  
PE171A48  
PE171A72

171

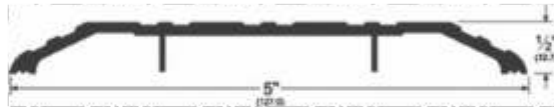

**Flat Saddle Thresholds**

PE175A48  
PE175A72



270



**Fluted Saddle Threshold**

PE270A36  
PE270A42

271

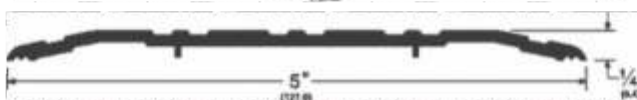

**Fluted Saddle Threshold**

PE271A36  
PE270A72



**Half Saddle Threshold**

PE229A36  
PE229A72

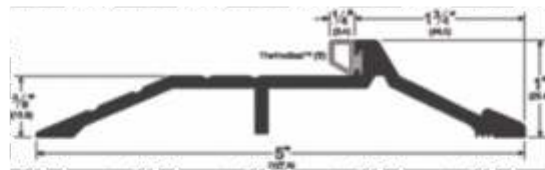

**Latching Panic Exit Saddle**

PE181AT36  
PE181AT48

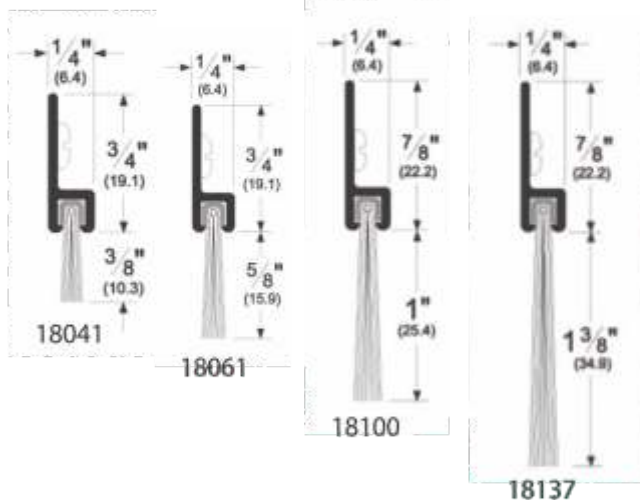

**Brush Meeting Stile Gasketing**

PE18041CNB3684  
PE18041CNB48  
PE18041CNB84/2  
PE18041DNB3684  
PE18041DNB48  
PE18041DNB7284  
PE18041DNB84/2  
PE18061CNB3684  
PE18061CNB7284

**Brush Weatherstrip 1" Nylon**

PE18100CNB36  
PE18100CNB42  
PE18100DNB36  
PE18100DNB48

**Brush Weatherstrip 1 1/2" Nyl**

PE18137CNB36  
PE18137CNB48  
PE18137DNB36  
PE18137DNB48

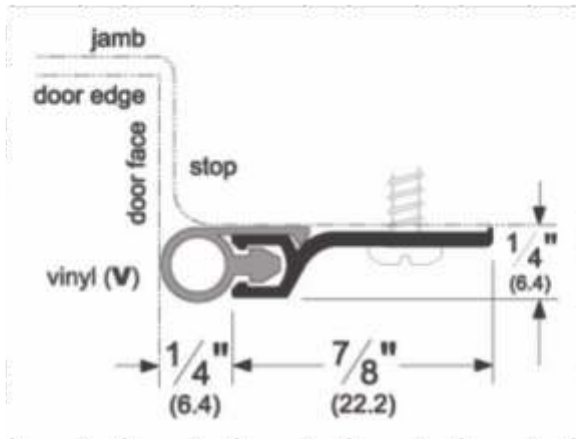

**Jamb Weatherstrip Gray Vinyl**  
PE303AV3684

**Jamb Weatherstrip Blk Vinyl**  
PE303DV3684

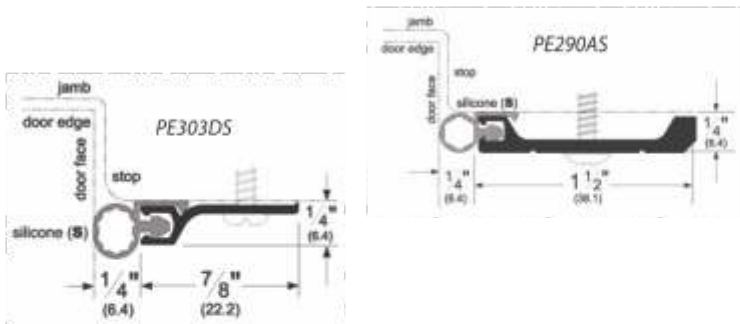

**Jamb Weatherstrip Blk Silicone**  
PE290AS3684  
PE303CS3684  
PE303CS7284  
PE303DS3684  
PE303DS7284

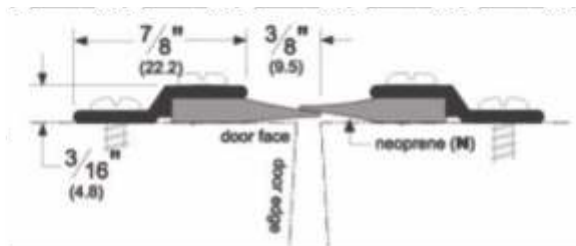

**EPDM Meeting Stile Gasketing**  
PE305CN84/2

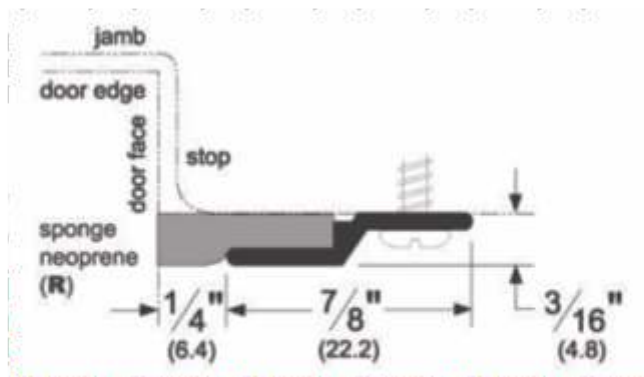

**Jamb Weatherstrip EDPM  
Sponge**  
PE305CR3684

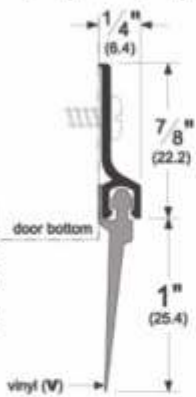

**Door Bottom Sweep 1" Vinyl**

PE307AV36  
PE307AV42  
PE307AV48  
PE307DV36  
PE307DV42

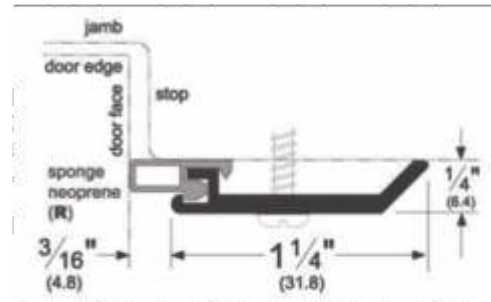

**Jamb Weatherstrip Sponge Seal**  
PE315CR3684

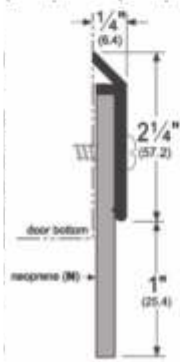

**Door Bottom Sweep 1" Neoprene**

PE3151CN36  
PE3151CN48  
PE3151DN48  
PE3151DNX

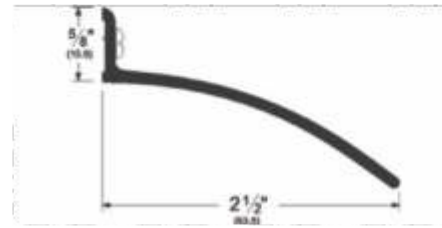

**Rain Drip**

PE346C40 Clear ALUM  
PE346C76 Clear ALUM  
PE346D40 Dark Bronze  
PE346D76 Dark Bronze

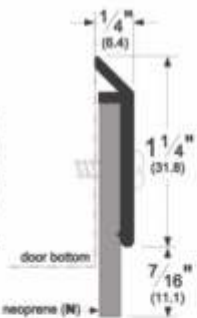

**Door Bottom Sweep 7/16" Neo**

PE315CN36  
PE315CN48  
PE315DN36  
PE315DN48

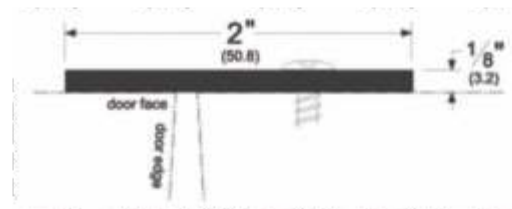

**Overlapping Astragal Alum**

PE357C84  
PE357D84  
PE357SP84

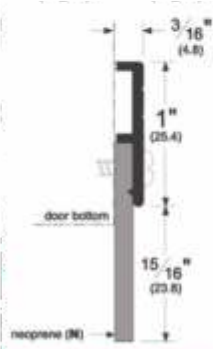

**Door Bottom Sweep 15/16" Neo**

PE321CN36  
PE321CN48  
PE321DN36

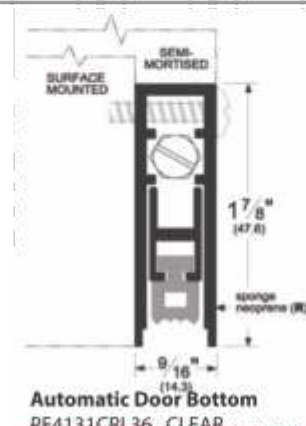

**Automatic Door Bottom**

PE4131CRL36 CLEAR  
PE4131CRL48 CLEAR  
PE4131DRL36 DKBRZ



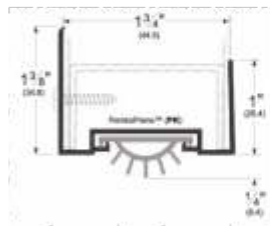
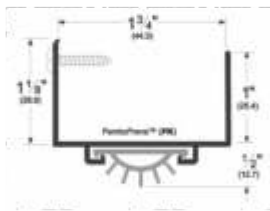

**Door Shoe Mill Finish Alum**  
PE217APK36  
**Door Shoe For Hollow Metal Dr**  
PE222APK36

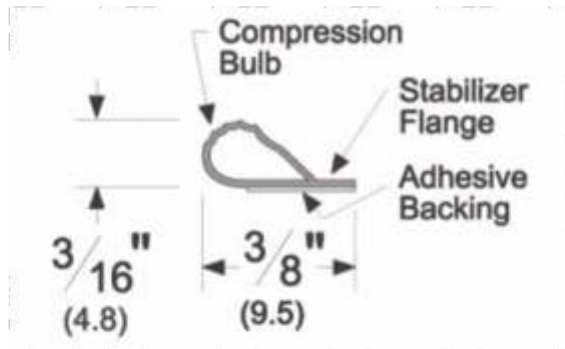

**Weatherseal Black Pemkprene**  
PEPK33BL20

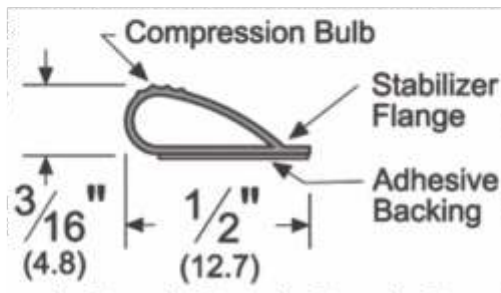

**Pemkprene Smoke Gasketing**  
PEPK55BL17  
PEPK55BL21

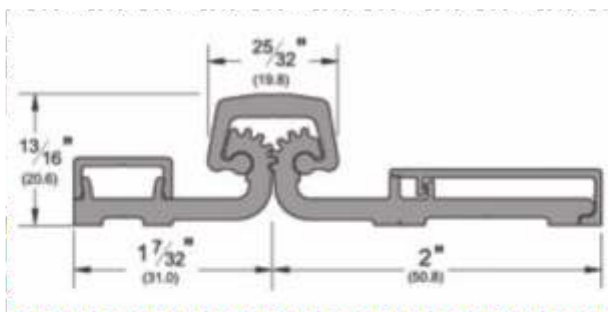

**Full Surface Center Pivot 83"**  
PECFS83CP  
PEDFS83CP  
PECFS83CP-HD1  
PEDFS83CP-HD1

**2100 SERIES**



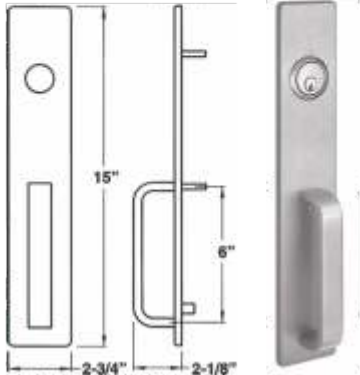

PH3R02103-RHRB-630	PH3R02108-RHRB-630	<i>PHI WIDE STILE RIM DEVICE</i>
<i>Features:</i>	PH3R02408-RHRB-630	<i>PHI NARROW STILE RIM DEVICE</i>
• For 36" doors	PH3R0FL2108-RHRB-630	<i>PHI FIRE-RATED RIM DEVICE</i>
• Stainless Steel, Deadlocking, 3/4" throw	PH3R02908A-LHRB-630	<i>PHI KEY CONTROL LEVER TRIM</i>
• Exit Device Only	PH3R02908A-RHRB-630	<i>PHI KEY RETRACT LB LEVER TRIM</i>
	PH3R04903A-LHRB-630	<i>PHI KEY RETRACT LB LEVER TRIM</i>
	PH3R04903A-RHRB-630	<i>PHI KEY RETRACT LB LEVER TRIM</i>
	PH3R04908A-LHRB-630	<i>PHI KEY CONTROL LEVER TRIM</i>
	PH3R04908A-RHRB-630	<i>PHI KEY CONTROL LEVER TRIM</i>

**APEX TRIM**

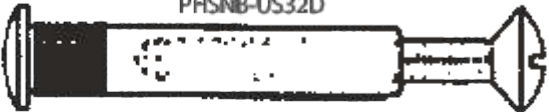
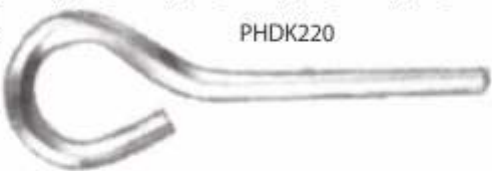

<b>1703A-US32D</b>	PH3R04908A-LHRB-630	<i>PHI Key Control Lever Trim</i>
<i>Key Retracts Latchbolt (supplied less cylinder)</i>	PH3R04908A-RHRB-630	<i>PHI Key Control Lever Trim</i>
PH3R01703A-630	PH3R0FL2108-RHRB-630	<i>PHI Fire-Rated Rim Device</i>
	PH3R04908A630	<i>PHI Key Control Lever Trim</i>
	PH3R04914A630	<i>Exit Trim-Passage</i>

**PARTS**

<p><b>PHSNB-US32D</b> Sex Bolt PHSNB-US32D</p> 	<p><b>PHDK220</b> 7/32" Standard Hex PHDK220</p> 	
		<p><b>PHCDK-3 628</b> Cylinder Dogging Kit</p>

**TEMPLATES & JIGS**



**Killer Jig Installation Kit**

The Killer Jig Kit includes everything a professional installer needs to prepare doors and door jambs for hardware.

PLINJIG-KJ



**Professional Universal Clamp**

The new INCL-PRO: Professional Series Universal Clamp is the cornerstone of our modular PRO-LOK® IN-Series Installation Template system. It is designed to hold both (2) the front and back specialty IN-series templates at one time, for one easy set-up and lightening fast door prep!

PLINCL-PRO

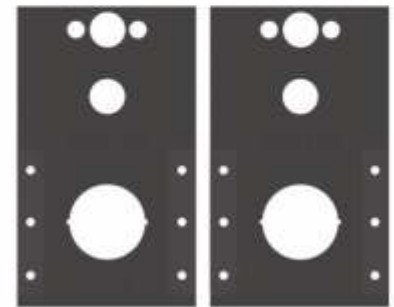

**Simplex 1000 - L1000 - 5000 Template Set**

The Kaba I/CO Simplex 1000 PRO templates prep doors for an accurate installation of Simplex 1000 Series push button locks

PLIN10-PRO

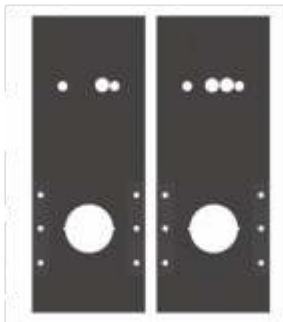

**Schlage Co Cylindrical**

The PRO Schlage CO-Series templates prep doors for Schlage CO-Series standalone mechanized cylindrical lock installations

PLIN510-PRO

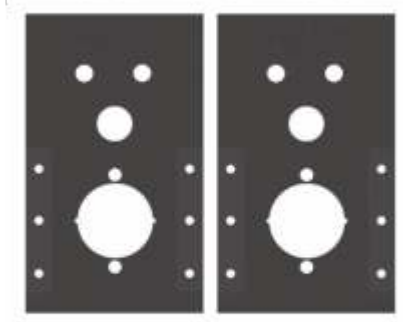

**Alarm Lock Trilogy Templates**

The Alarm Lock Trilogy T2 PRO templates prep doors for an accurate installation of the new trilogy T2-series push button lockset.

PLIN15-PRO

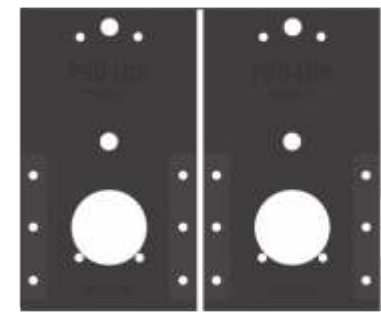

**Kaba E5000 Cylindrical**

The Kaba E-Plex 5000 PRO templates prep doors for both Kaba E-Plex 5000 Series cylindrical lock installations.

PLIN650-PRO

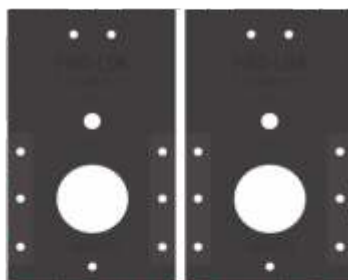

**Kaba E2000 Cylindrical**

The Kaba E-Plex 2000 Series Cylindrical PRO templates prep doors for Kaba E-Plex 2000 Series cylindrical lock installations.

PLIN640-PRO

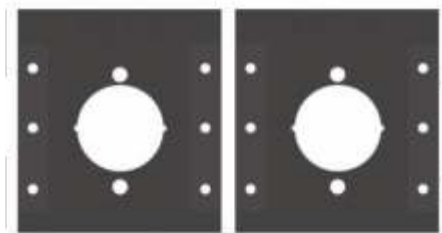
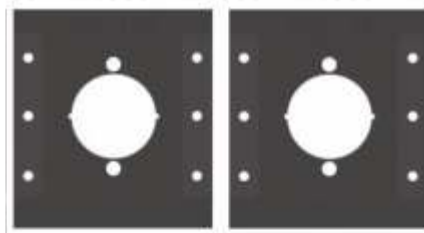

**Cylindrical Lock Template**

- PLIN20-PRO      2 3/4" CTC THRU-BOLTS      2 1/8" CROSSBORE
- PLIN78-PRO      2 5/8" CTC THRU-BOLTS      2 1/8" CROSSBORE
- PLIN79-PRO      BEST LOCK 9K TEMPLATE SET
- PLIN490-PRO      YALE INTOUCH/ARROW REVOLUTION TEMPLATE SET



## CAR OPENING TOOLS



### PLAO-01 LG-Handy Slide Lock

This is two tools in one! The Slide Lock tool will open horizontal locking devices. The Large Handy tool will open vertical buttons fast and easy.

PLAO-01 Handy Slide Lock



### PLAO-04 Gas Cap Key

This "key" is designed to open almost any auto gas cap. This tool works as a key pick allowing you to open the lock.

PLAO-04 Gas Cap Key



### PLAO-07 Astro Tool

Newly redesigned, this tool not only opens the Astro Van, but also opens several new Toyotas! The hook and the inward reach of the shaft combined make this tool extremely useful.

PLAO-07 Astro Tool



### PLAO-10 The Slim Jim

This is the original Slim-Jim, and still the best. Why buy an inferior look alike when you can own the real thing? Made of high carbon spring steel with a vinyl grip. Notched correctly to open a variety of automobiles.

PLAO-10 The Slim Jim



### PLAO-11 Super Slim Jim

Wider and thicker than the original. This tool will allow you to open many foreign and domestic vehicles. Manufactured of the highest quality materials with a custom vinyl grip.

PLAO-11 Super Slim Jim



### PLAO-21 Toyota Tool

This tool has been specially designed to open the shrouded vertical button cars such as the 4-Runner, Pick-up, Corolla, and Tercel 4dr. This will also open several of the horizontal lock devices such as the Cressida. If you have ever had difficulty opening any of these cars then this tool is for you!

PLAO-21 Toyota Tool



### PLAO-25 EZ Jim

Designed to open cars and trucks with vertical locking devices and lazy pawls. Manufactured of high carbon spring steel with vinyl handle and illustrated instructions included.

PLAO-25 EZ Jim

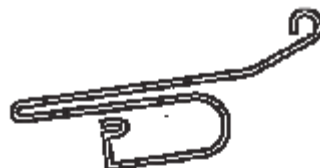

### PLAO-27 MCOT Handle Pull Tool

The MCOT-Handle Pull Tool is designed to access and manipulate pull handles on vehicles that have stiffer handle springs such as certain BMW, Mercedes and Land Rovers. Xacto-Grip Flattened.

PLAO-27 MCOT Pull Tool



### PLAO-28 MCOT Fat Tool

The MCOT-Fat Tool is designed to bypass window regulators that run the length of the window glass which inhibits the entry of the original type M.C.O.T. tools. Xacto-Grip Flattened.

PLAO-28 MCOT Fat Tool



### PLAO-30 X-Long Slim Jim

Bigger is better! With the Xtra Long Slim Jim You will be able to reach even the deepest linkage. Just like the original, only longer. Bright plated with a vinyl handle.

PLAO-30 X-Long Slim Jim



### PLAO-31 MCOT Button Lifter

Designed to open vehicles with raised vertical rods

PLAO-31 MCOT Button Lifter



### PLAO-32 MCOT Wide Extra Long

Has a wide reach and extra long length for even more versatility.

PLAO-32 Wide Extra Long



### PLAO-33 MCOT Wide Extra Long

Allows entry of the "under the window tool", where the inner panel deflector prevents entry.

PLAO-33 Wide Extra Long



### PLAO-34 MCOT Narrow

The original patented MCOT tool. These revolutionary tools go under the window and inside the car! The easiest-to-use car opening tool ever invented.

PLAO-34 MCOT Narrow

**CAR OPENING TOOLS — continued**



**PLAO-35 MCOT Wide**

The widest MCOT tool. Use this tool on cars with wide door panels where you must push or pull a slide lock handle.

PLAO-35 MCOT Wide



**PLAO-36 MCOT Long**

The newest MCOT tool. The original patented MCOT has been lengthened for maximum reach. Use on full size trucks for EZ entry.

PLAO-36 MCOT Long



**PLAO-37 Button Finger**

The MCOT modified to operate vertical button cars. Works on many Toyotas and other imports.

PLAO-37 Button Finger



**PLAO-38 Toyota Tool**

Used to open all 93 and 94 Hondas and a number of other foreign and domestic vehicles.

PLAO-38 Honda Tool



**PLAO-39 Double Slide Tool**

Short reach for narrow doors combined with reverse tip for horizontal rods.

PLAO-39 Double Slide Tool



**AO42-LA 58" Long**

This versatile tool is designed to enter into the passenger compartment of the vehicle through the door using wedges and/or door jack type tools. The soft vinyl tip allows for easy lock manipulation.

PLAO42-LA 58" Long



**AO42-LAXL Extra Length Long**

The AO42-LAXL is capable of reaching across the vehicle to manipulate interior lock mechanism.

PLAO-42-LAXL Extra Length Long

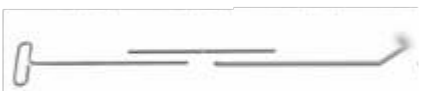

**PLAO42-QC1 Quick Change Long**

The AO42-QC1, Quick Change Long Reach Tool, gives you the versatility to unlock many vehicles on the road.

PLAO-42-QC1 Quick Change Long



**PLAO-42 Long Reach Tool**

This is an across-the-car entry tool. Allows to reach an activator on opposite door or retrieve the keys.

PLAO-42 Long Reach Tool

**PLAO-42SL Long Reach Sleeve**

Plastic sleeve that works with an AO-42 tool to protect the glass while the tool is in use.

PLAO-42SL Long Reach Sleeve

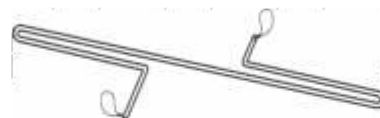

**PLAO-45 Loop-D-Loop Tool**

This unique double ended tool offers a new approach to lockouts on many BMWs, Mercedes, Volvos, and Volkswagens among others. Fed in under the window, the loop is fixed around the straight or mushroom style button head and pulled tight, then lifted up to unlock.

PLAO-45 Loop-D-Loop Tool



**PLAO-60 DBL Sided Wedge**

This tool will maximize the use of your car opening tools. Insert the wedge into the window to allow maximum tool maneuverability. Double ended unbreakable plastic.

PLAO-60 DBL Sided Wedge

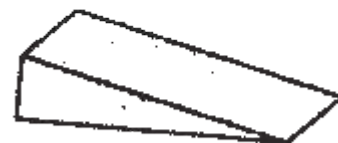

**PLAO-61 HD Rubber Wedge**

This wedge is made of heavy duty non-marking high-grade rubber. Insert the wedge between the window and the weatherstripping to cut opening time in half.

PLAO-61 HD Rubber Wedge



**PLAO-65 Pump Wedge**

Window wedge for auto opening. The pump wedge is an inflatable wedge made of non-marring vinyl material. Rounded corners for easy entry. Other uses may also include door and safe installations for leveling or holding in place while installation is being done.

PLAO-65 Pump Wedge



## KITS



### PLAK-60 Master Kit

The Master Kit is designed to provide the professional technician with a general use lock-out kit. Packed in our heavy duty cloth case, with a tool instruction booklet.

**TOOLS:** AO07, AO10, AO14, AO16, AO25, AO29, AO34, AO35, AOCC

**BOOK:** AO95 **CASE:** AO53

**WEDGE:** AO61

PLAK-60 Master Kit



### Ultra Combo Kit

The Combo Kit is a mix of the most popular traditional car opening tools snugly fit into the lid of the case as well as our assortment of 5 "Quick Change" Long Reach Tools custom fit into the bottom of the specialty molded case. The selection of traditional tools includes our most popular stainless steel round edged Slim Jim, and a variety of tools featuring Xacto-Grip technology.

**Tools:** AO25, AO35, AO38, AO39, AO42-QC1, AO42-QC2, AO42-M1, AO42-M2, AO42-M3, AO42SL, AO65-A1. **Book:** AO95. **Wedge:** AO65, Set of AO64, (2) AO67

PLAKUC Ultra Combo Kit

## KEY MACHINE

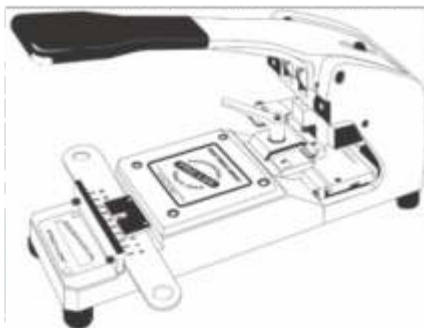

### Blue Punch Key Machine

The Blue Punch key machine is a dedicated key punch machine designed to provide "factory original" keys. Creates keys with the speed of a duplicator. The machine is set up at the factory to provide automatic spacing and depth. Precision machined to the tightest tolerances. Portable and dependable, hand operated - no electrical outlet needed.

### PLBP201SC - SCHLAGE CLASSIC

- Schlage Classic (C, CE, E, EF, F, FG, G, H, J, K, L)
- Primus, Everest, Everest Primus
- Exclusions: Numbered Key Sections, Quad Key Sections, Reverse Key Sections, Everest B (B + 3 digits), Everest D (D + 3 digits)

### PLBP201IC - A2 I/CORE

- Best, Falcon, and Arrow
- Primus, Everest, Everest Primus
- Exclusions: Numbered Key Sections, Quad Key Sections, Reverse Key Sections, Everest B (B + 3 digits), Everest D (D + 3 digits)

PLBP201C70 Blue Punch Corbin System 70  
 PLBP201HA Blue Punch Hager  
 PLBP-SPHAN Blue Punch Handle Springs (2)



PLBP-SPHAN



## DRILL BITS

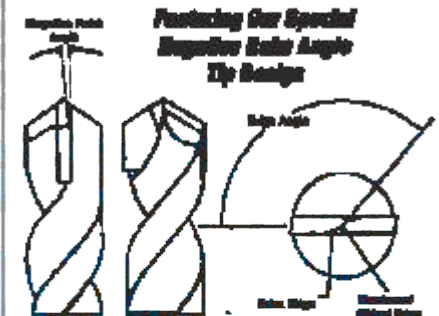

PLSB01	3/16" x 3 1/2"
PLSB02	3/16" x 6"
PLSB05	1/4" x 4"
PLSB06	1/4" x 6"
PLSB11	5/16" x 5"
PLSB12	5/16" x 8"
PLSB15	3/8" x 5"
PLSB16	3/8" x 8"
PLSB20	1/2" x 6"



TOOLS



**PLAO-85 Euro Strip**

*Flexible tool allows you to bypass door frames on Mercedes, BMW, Volvo and other vehicles.*

**PLAO-85 Euro Strip**



**PLAL-2039 Replacement Wand**

*Replacement wand for AL 10500, AL 15500, AL 2000. Does not include bulb.*

**PLAL-2039 Replacement Wand**



**PLLT1202 Pocket Otoscope**

*Made of tough impact-resistant plastic. This scope throws a strong beam of light, great for reading wafers and safe work. 3 tips and pouch included.*

**PLLT1202 Pocket Otoscope**



**PLAL-15500 Krypton Light  
Hard Body Metal**

*3-Cell hardbody light. Aluminum body car opening light powered by 3 AA batteries. Use AL 12110 bulb only. Lifetime warranty.*

**PLAL-15500 Krypton Light**

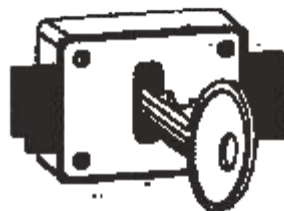

**PLLT300 The Keycheck**

*Forms and holds keyway on any sample key and allows you to match the right blank every time.*

**PLLT300 The Keycheck**



**PLLT370 Master Pin Follower**

*This versatile follow tool can be used for rekeying on most standard commercial and residential brands of lock hardware. Used for quick removal of upper-chamber master pins, a quick twist removes and dumps pins. Also used for standard rekeying, this red-anodized, milled aluminum tool is sure to be a favorite.*

**PLLT370 Master Pin Follower**



**PLAL-12110 Krypton Bulb**

*Replacement. Standard bulb for AL-15500. Krypton Light. Gas filled.*

**PLAL-12110 Krypton Bulb**



**PLINJIG-116 Strike Locator**

*After the 1" edge bore is drilled, insert the Strike Locator into the hole, close the door, press the Strike Locator towards the door frame and the sharp center piece marks the frame where to drill for proper latch or deadbolt alignment.*

**PLINJIG-116 1" Strike Locator**



**PLPKXGUN-M Pick Gun**

*The Best Gun Made! This high quality pick gun, used by locksmiths everywhere comes complete with 3 spare tips and a tension wrench. Using this pick gun will allow you to pick other-wise "unpickable" locks. (See HP P-2 for Replacement Picks)*

**PLPKXGUN-M Pick Gun**



**PLLT700**

**Standard Impressioning Tool**

*Aluminum Impressioning tool for pin tumbler and wafer locks using a true centerline action. Easy to grip, fits hands comfortable, securely holds the head of the key.*

**PLLT700 Impressioning Tool**

**Latch Marker**

*Heavy Duty Latch Marker is used for marking the wood door when mortising many standard deadbolt and latch face plates.*

**PLINJIG-101 1" x 2 1/4"**  
**PLINJIG-102 1 1/8" x 2 1/4"**



**PLZGRT Tool Tip**

*Replacement tool tips. The large tool tip is 1 1/2"*

**PLZGRT-GREEN Tool Tip**  
**PLZGRT-BLACK Tool Tip**  
**PLZGRTX-YELLOW-LARGE Tool Tip**

## PICKS & PICK SETS

Each pick set comes with a soft luggage quality leathercase.



**PLPKX-11 Pick Set**  
11 Picks & Case



**PLPKX-14 Pick Set**  
14 Picks & Case



**PLPKX-20 Pick Set**  
20 Picks & Case



**PLPKX-32 Pick Set**  
32 Picks & Case

Our high quality picks are manufactured of tempered stainless steel; deburred and burnished to a soft luster. We use the newest high technology steels and construction methods. Our picks are rust proof, full hard spring stainless steel with smooth rivetless construction making them the strongest most durable picks available.



**PLPKX-DB-H** Double Ball with Handle



**PLPKX-DM-H** Dbl. Mtn. with Handle



**PLPKX-HDS-H** Sm. 1/2 Dmrd. with Handle



**PLPKX-KE-H** Broken Key Extractor



**PLPKX-LC-H** Large Comb with Handle



**PLPKX-LH-H** Large Hook with Handle



**PLPKX-MH-H** Med Hook with Handle



**PLPKX-SC-H** Small Comb with Handle



**PLPKX-TW-F** Tension Wrench Forked



**PLPKX-TR-H** Tdl. Rake with Handle

- |                    |                        |                    |                            |
|--------------------|------------------------|--------------------|----------------------------|
| <b>PLPKX-DB-H</b>  | Double Ball/ Handle    | <b>PLPKX-LH-P</b>  | Large Hook/ Plain          |
| <b>PLPKX-DB-P</b>  | Double Ball/ Plain     | <b>PLPKX-MH-H</b>  | Medium Hook/ Handle        |
| <b>PLPKX-DM-H</b>  | Double Mtn/ Handle     | <b>PLPKX-MH-P</b>  | Medium Hook/ Plain         |
| <b>PLPKX-DM-P</b>  | Double Mtn/ Plain      | <b>PLPKX-SB-H</b>  | Single Ball/ Handle        |
| <b>PLPKX-DR-C</b>  | Combo Diamond/ Rake    | <b>PLPKX-SB-P</b>  | Single Ball/ Plain         |
| <b>PLPKX-HDS-H</b> | Sm 1/2 Diamond/ Handle | <b>PLPKX-SC-H</b>  | Small Comb/ Handle         |
| <b>PLPKX-HDL-H</b> | Lg 1/2 Diamond/ Handle | <b>PLPKX-SC-P</b>  | Small Comb/ Plain          |
| <b>PLPKX-HDL-P</b> | Lg 1/2 Diamond/ Plain  | <b>PLPKX-TR-H</b>  | Traditional Rake/ Handle   |
| <b>PLPKX-HDS-P</b> | Sm 1/2 Diamond/ Plain  | <b>PLPKX-TR-P</b>  | Traditional Rake/ Plain    |
| <b>PLPKX-HR-C</b>  | Combo Hook/ Rake       | <b>PLPKX-TW-F</b>  | Tension Wrench Forked      |
| <b>PLPKX-KE-H</b>  | Key Extractor          | <b>PLPKX-TW-L</b>  | Tension Wrench Light       |
| <b>PLPKX-KE-P</b>  | Key Extractor/ Plain   | <b>PLPKX-TW-M</b>  | Tension Wrench Medium      |
| <b>PLPKX-LC-H</b>  | Lg Comb/ Handle        | <b>PLPKX-TW-R</b>  | Tension Wrench Rigid       |
| <b>PLPKX-LC-P</b>  | Lg Comb/ Plain         | <b>PLPKX-TW-TL</b> | Tension Wrench Lg Twist    |
| <b>PLPKX-LH-H</b>  | Lg Hook/ Handle        | <b>PLPKX-TW-TS</b> | Tension Wrench Short Twist |

**PLMAEZ2 EZ Picking Manual - Color**

## KEY DECODERS

Decode depths for positive identification. Each decoder uses stepped depths for exact decoding. Use for rekeying and code cutting.



**PLKD01** Key Decoder

**PLKD01**  
Key Decoder  
For Schlage, Kwikset,  
Weiser & Weslock



**PLKDIC** Key Decoder

**PLKDIC**  
Key Decoder  
For Falcon & Best



**PLKD03** Key Decoder

**PLKD03**  
Key Decoder  
For GM, Ford,  
Ford 10 & Chrysler



**PLKDSC** Key Decoder

**PLKDSC**  
Key Decoder  
For Schlage



**ENTRY ARMOR**

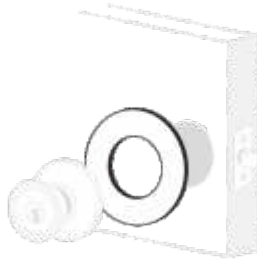

**PLEAP-100 Adapter Plate**

Covers up wood damage around the lock. For mortise and rim cylinders. 1 1/4" inside diameter. 2 3/8" outside diameter.

PLEAP-100B Brass 2 3/8"

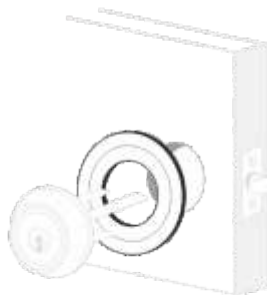

**PLEAP-110 Adapter Plate**

Changes 2 3/8" bore to 1 1/2" bore. Cover up small wood damage around the lock. Includes 2 plates. 1 1/2" inside diameter. 2 3/4" outside diameter.

PLEAP-110B Brass 2 3/4"  
PLEAP-110C Chrome 2 3/4"



**PLEAP-120 Adapter Plate**

Covers up wood damage around the lock. For locks with a 2 3/8" bore. Convert holes from 2 3/8" to 2 3/4" backset. Allows for use of Grade 1 key-in-lever locks on 1 3/8" door. 2 3/8" inside diameter. 3 1/2" outside diameter.

PLEAP-120-AB Antique Brass 3 1/2"  
PLEAP-120-B Brass 3 1/2"  
PLEAP-120-C Chrome 3 1/2"

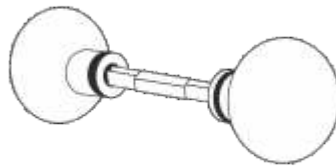

**PLEDK-100**

**Knob Set-Brass w/Spindle**

Solid brass knob set. Spindle included.

PLEDK-100-PB Polished Brass

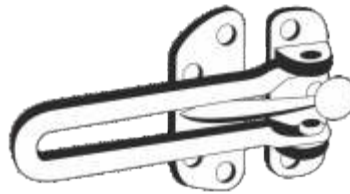

**PLEDL-100 Door Guard Swing Bar**

Works on in-opening doors. Size: 2 1/2" x 4"

PLEDL-100-B Brass  
PLEDL-100-C Chrome

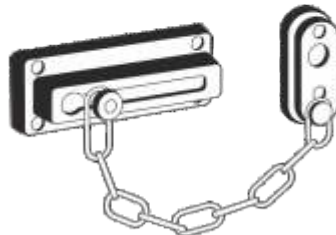

**PLEDL-110 Door Guard Chain**

For wood or metal doors. Extra long screws included. Size 2 1/4" x 4 1/4". 3 3/8" chain.

PLEDL-110-AB Antique Brass  
PLEDL-110-B Brass

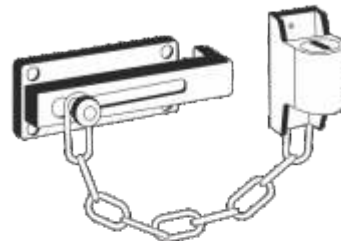

**PLEDL-130**

**Door Guard Key Locked Chain**

Lock & unlock from the inside & the outside. Keyed lock with 2 keys included. Size: 2 1/4" x 4 1/4"

PLEDL-130-B Brass



**PLEDV-100**

**Door Viewer - 160° 1/2"**

Clear glass lens. Fire Proof and scratch proof lens. Moist/water proof. For doors 1 3/8" to 2" thick. 1/2" barrel diameter.

PLEDV-100-PB Polished Brass

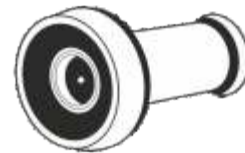

**PLEDV-120**

**Door Viewer - 190° 1/2"**

Wide angle clear lens. Fire proof and scratch proof lens. Moist/water proof. For doors 1 3/8" to 2" thick. 1/2" barrel diameter.

PLEDV-120-C Chrome  
PLEDV-120-PB Polished Brass

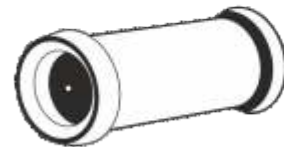

**PLEDV-130**

**Door Viewer - 160° 1"**

Super-wide view lens. Fire Proof and scratch proof lens. Moist/water proof. For doors 1 3/8" to 2" thick. 1" barrel diameter.

PLEDV-130-PB Polished Brass

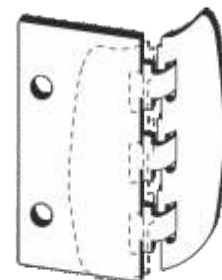

**PLEFL-100**

**Privacy Flip Lock**

For in-opening doors. Left or right handed doors. Size: 2 3/4" x 1 1/2"

PLEFL-100-B Brass  
PLEFL-100-W White



**ENTRY ARMOR — continued**



**PLEFP-100**  
**Filler Plate 8" x 1 1/4"**

Converts 86 cut-out to 161 prep. 3/8" off center line. Bulk packaged, 1/poly bag. Size: 8" x 1 1/4"

PLEFP-100-PC Prime Coat

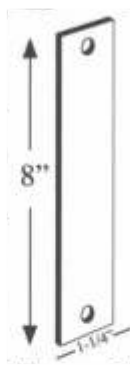

**PLEFP-130**  
**Filler Plate 8" x 1 1/4"**

Filler plate for an 86 mortise lock face cut-out. Bulk packaged, 1/poly bag. Size: 8" x 1 1/4"

PLEFP-130-PC Prime Coat

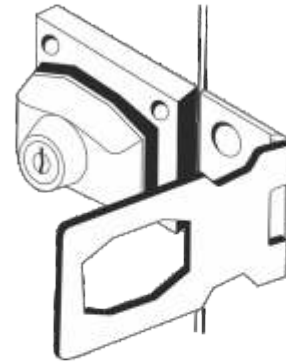

**PLELK-110**  
**Hasp Lock 4 1/2"**

Use on doors, gates, trunks, or boxes. Keyed for additional protection. Size: 2" x 4 1/2"

PLELK-110-C-KA  
PLELK-110-C-KD

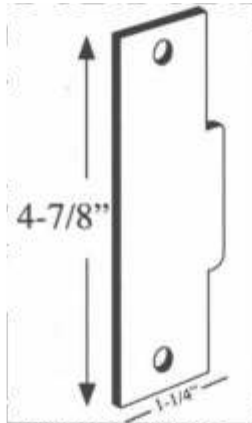

**PLEFP-110**  
**Filler Plate 4 7/8" x 1 1/4"**

Bulk packaged, 1/poly bag. Size: 4 7/8" x 1 1/4"

PLEFP-110-PC Prime Coat

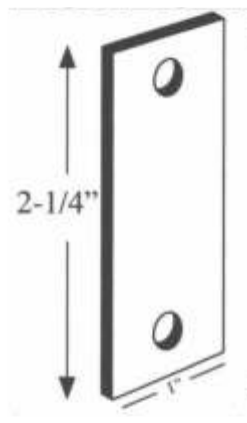

**PLEFP-131**  
**Filler Plate 2 1/4" x 1"**

Filler plate for a 160 cut-out. Bulk packaged, 1/poly bag. Size: 2 1/4" x 1"

PLEFP-131-PC Prime Coat

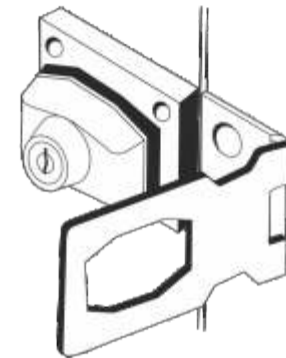

**PLELK-111**  
**Hasp Lock 2 1/2"**

Use on doors, gates, trunks, or boxes. Keyed for additional protection. Size: 1 1/2" x 2 1/2"

PLELK-111-KA  
PLELK-111-KD

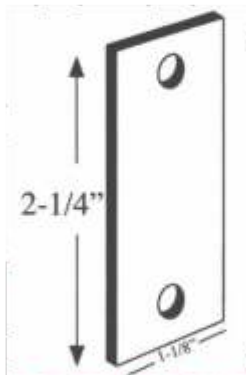

**PLEFP-120**  
**Filler Plate 2 1/4" x 1 1/8"**

Filler plate for 161 cut-out. Bulk packaged, 1/poly bag. Size: 2 1/4" x 1 1/8"

PLEFP-120-PC Prime Coat

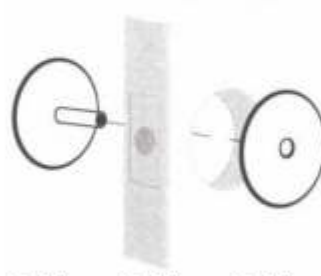

**PLEHC-100**  
**Hole Cover - 2 1/2"**

Hole Cover for 1 1/2" or 2 1/2" holes.

PLEHC-100-B Brass  
PLEHC-100-C Chrome  
PLEHC-100-PC Prime Coat



**PLELK-130-C**  
**Showcase Lock**

Locks sliding glass doors. Keyed lock with 2-keys included.

PLELK-130-C

**ENTRY ARMOR — continued**



**PLELP-100**

**Latch Protector - 7" Interlocking**

*For in opening doors. Deters spreading the door from the frame. All backsets, deadbolts and key-in-knobs lock sets. Size: 7" x 5/8".*

PLELP-100-AL Aluminum  
PLELP-100-DU Duronotic



**PLELP-200**

**Latch Protector - 6" Center Rose**

*Protect the latch or deadbolt. For out-opening doors. For all backsets, deadbolts and key in knob locks. Accepts up to a 3 1/2" rose. Size: 6" x 2 1/2".*

PLELP-200-AL Aluminum  
PLELP-200-B Brass  
PLELP-200-C Chrome



**PLELP-220**

**Latch Protector - 11" LH Door**

*For out-opening doors. Accepts up to a 3 1/2" rose. All backsets, deadbolts and key-in-knob locks.*

PLELP-220-I-S-BULK Aluminum  
PLELP-220-2-S-BULK Duronotic



**PLELP-110**

**Latch Protector - 12" Interlocking**

*For in opening doors. Deters spreading the door from the frame. All backsets, deadbolts and key-in-knobs lock sets. Size: 12" x 3/4".*

PLELP-110-AL Aluminum  
PLELP-110-DU Duronotic

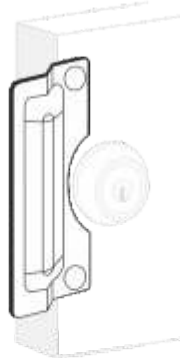

**PLELP-210**

**Latch Protector - 7" Center Rose**

*For out-opening doors. Accepts up to a 3 1/2" rose. All backsets, deadbolts and key-in-knob locks.*

PLELP-210-AL Aluminum  
PLELP-210-DU Duronotic



**PLELP-120**

**Latch Protector - T Style 6" x 1 3/4"**

*Use on in and out opening doors. Resist tampering of bolt and latch. Size: 6" x 1 3/4".*

PLELP-120-AL Aluminum  
PLELP-120-B Brass

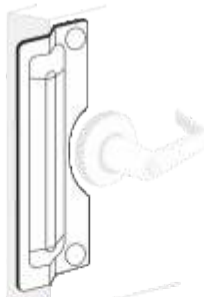

**PLELP-220**

**Latch Protector - 11" Center Rose**

*For out-opening doors. Accepts up to a 3 1/2" rose. All backsets, deadbolts and key-in-knob locks.*

PLELP-220-AL Aluminum  
PLELP-220-DU Duronotic

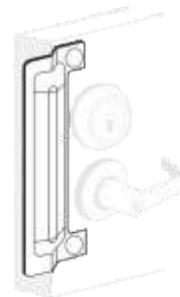

**PLELP-240**

**Latch Protector - 13" Versatile**

*Accommodates a wide variety of lock sets. Includes spacers to adjust depth between or and jamb. For out-opening doors.*

PLELP-240-AL Aluminum  
PLELP-240-DU Duronotic  
PLELP-240-S Stainless

## ENTRY ARMOR — continued

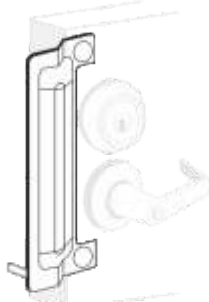

**PLELP-240-1**

**Latch Protector - 13" w/1-Pin Versatile**

Accommodates a wide variety of lock sets. Includes spacers to adjust depth between or and jamb. For out-opening doors.

PLELP-240-1-AL	Aluminum
PLELP-240-1-C	Chrome
PLELP-240-1-DU	Duronotic
PLELP-240-1-S	Stainless



**PLELP-250-1**

**Latch Protector - 11" w/1-Pin Rectangle**

Accommodates a wide variety of lock sets. Includes spacers to adjust depth between or and jamb. For out-opening doors.

PLELP-250-1-AL	Aluminum
PLELP-250-1-DU	Duronotic
PLELP-250-1-S	Stainless

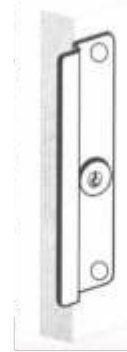

**PLELP-310**

**Latch Protector - 2 3/8" x 12" Narrow Stile**

For out-opening narrow stile doors. Special hardware included. Size: 12" x 2 3/8"

PLELP-310-AL	Aluminum
PLELP-310-DU	Duronotic

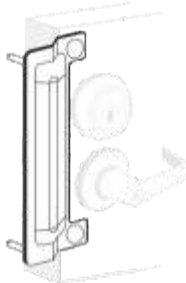

**PLELP-240-2**

**Latch Protector - 13" w/2-Pin Versatile**

Accommodates a wide variety of lock sets. Includes spacers to adjust depth between or and jamb. For out-opening doors.

PLELP-240-2-AL	Aluminum
PLELP-240-2-DU	Duronotic
PLELP-240-2-S	Stainless



**PLELP-250-2**

**Latch Protector - 11" w/2-Pin Rectangle**

Accommodates a wide variety of lock sets. Includes spacers to adjust depth between or and jamb. For out-opening doors.

PLELP-250-2-AL	Aluminum
PLELP-250-2-DU	Duronotic
PLELP-250-2-S	Stainless

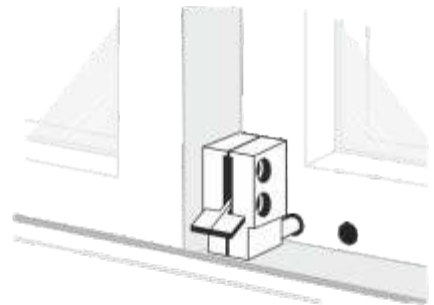

**PLEPL-100**

**Patio Door Lock - Lever**

Inside and outside sliding doors. Locks door in fully closed and ventilation position.

PLEPL-100-AL	Aluminum
--------------	----------

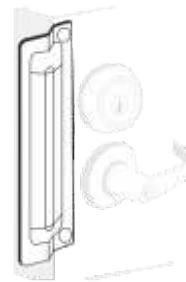

**PLELP-250**

**Latch Protector - 11" Rectangle**

Accommodates a wide variety of lock sets. Includes spacers to adjust depth between or and jamb. For out-opening doors.

PLELP-250-AL	Aluminum
PLELP-250-DU	Duronotic
PLELP-250-S	Stainless



**PLELP-300**

**Latch Protector - 2 1/2" Narrow Stile Door**

For out-opening narrow stile doors. Special hardware included.

PLELP-300-AL	Aluminum
PLELP-300-DU	Duronotic

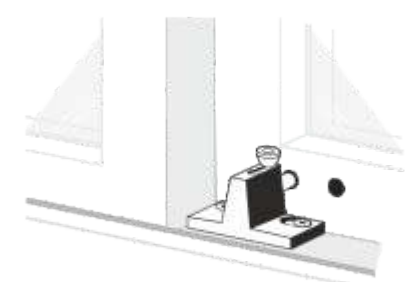

**PLEPL-101**

**Patio Door Lock - Top Knob**

Inside and outside sliding doors. Locks door in fully closed and ventilation position. Size: 1 1/2" x 2-1/4"

PLEPL-101-AL	Aluminum
PLEPL-101-W	White



**ENTRY ARMOR — continued**



**PLEPL-105**  
**Patio Door Lock - Keyed Lever**

Inside and outside sliding doors. Locks door in fully closed and ventilation position. Keyed lock with 2 keys. Size: 2 1/4" x 2"

PLEPL-105-AL Aluminum

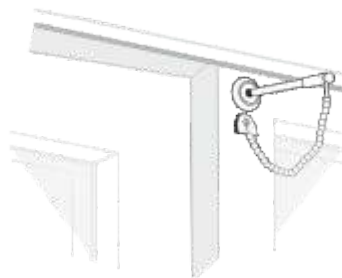

**PLEPL-110-AL**  
**Patio Door Lock - Pin**

Lock and unlock door quickly. Pin locks in place. Cut to length.

PLEPL-110-AL

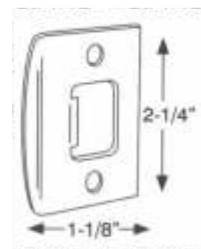

**PLESP-104**

**Strike Plate - Full Lip 2 1/4" x 1 1/8"**

Replaces standard strike plates. Fits in standard residential holes. Wood screws provided. Size: 2 1/4" x 1 1/8"

PLESP-104-B Brass  
PLESP-104-C Chrome



**PLEPL-106**  
**Patio Door Lock - Keyed Lg Rectangle**

Heavy duty steel bolt. Use on inside and outside sliding doors. Keyed lock with 2 keys. Size: 6" x 1 1/8"

PLEPL-106-AL Aluminum  
PLEPL-106-W White

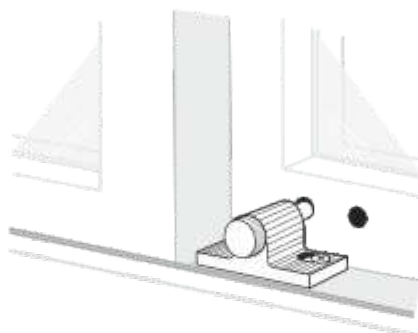

**PLEPL-111**  
**Patio Door Lock - Side Knob**

Inside and outside sliding doors. Locks door in fully closed and ventilation position. Size: 2" x 2 1/4"

PLEPL-111-AL Aluminum

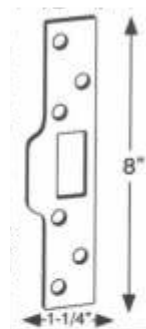

**PLESP-110**

**Strike Plate - Security Lip 8" x 1 1/4"**

Fortifies door jamb for added strength and security. Deters tampering and kick-ins. Includes 1 1/4" and 3" long screws. Size: 8" x 1 1/4"

PLESP-110-B Brass



**PLEPL-108**  
**Patio Door Lock - Lg Rectangle**

Heavy-Duty steel bolt. Use on inside and outside sliding doors. No key required. Size: 6" x 1 1/8"

PLEPL-108-W White

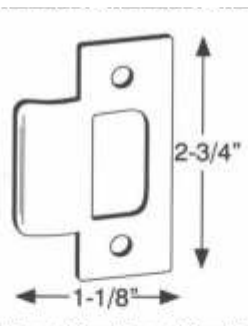

**PLESP-100**  
**Strike Plate - "T" 2 3/4" x 1 1/8"**

1 1/8" x 2 3/4". Replaces old strike plates. Fits in standard "T" cut out. Screws provided.

PLESP-100-B Brass  
PLESP-100-C Chrome



**PLESP-120**  
**Strike Plate - Large Lip**

Covers smaller strike plate holes. 2 1/2" long screws for increased security. Size: 4 1/8" x 1 1/4"

PLESP-120-B-BULK Brass  
PLESP-120-C Chrome

## ENTRY ARMOR — continued

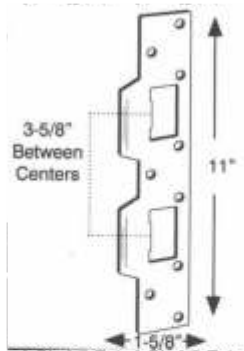

**PLESP-130**

**Strike Plate - Double Lip w/3 5/8" Center**  
Fits double locks with 3 5/8" or 4" centers.  
Size: 11" x 1 5/8"

PLESP-130-B Brass



**PLESP-141**

**Strike Plate - Security 7 3/4" w/6 Screws**  
Fortifies door jamb for added strength and security. Deters tampering and kick-ins. Includes 1 1/4" and 3" long screws.  
Size: 7 3/4" x 1 5/8"

PLESP-141-B Brass

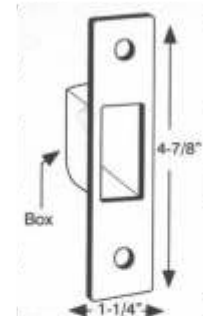

**PLESP-150**

**Strike Plate - High Security Box Strike**  
Box encloses bolt. Fortifies door jamb for added strength and security. Deters tampering and kick-ins. Includes 2" long screws.  
Size: 4 7/8" x 1 1/4"

PLESP-150-B Brass  
PLESP-150-C Chrome

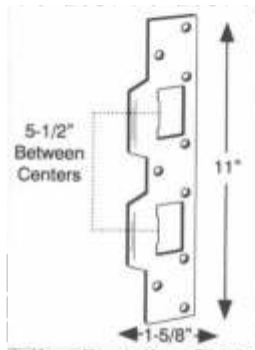

**PLESP-131**

**Strike Plate - Double Lip w/5 1/2" Center**  
Fits double locks with 5 1/2" or 6" centers.  
Size: 11" x 1 5/8"

PLESP-131-B Brass



**PLESP-142**

**Strike Plate - Security 6" w/4 Screws**  
Fortifies door jamb for added strength and security. Deters tampering and kick-ins. Includes 1 1/4" and 3" long screws. Size: 6" x 1 5/8"

PLESP-142-B Brass



**PLESP-170**

**Strike Plate - Mortise 4 7/8" x 1 1/4"**  
Bulk packaged, 1/poly bag. Size: 4 7/8" x 1 1/4"

PLESP-170-C-BULK Chrome

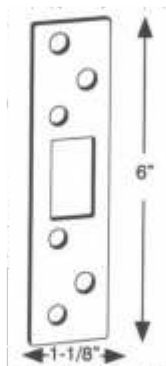

**PLESP-140**

**Strike Plate - Security 6" w/6 Screws**  
Six 1-1/2" long screws included for additional holding power. Size: 6" x 1-1/8"

PLESP-140-B Brass  
PLESP-140-C Chrome



**PLESP-143**

**Strike Plate - Security 4 7/8" w/4 Screws**  
Fortifies door jamb for added strength and security. Deters tampering and kick-ins. Includes 1 1/4" and 3" long screws. Size: 4 7/8" x 1 1/4"

PLESP-143-B Brass

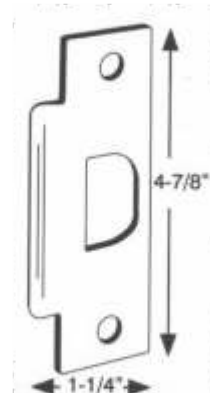

**PLESP-171**

**Strike Plate - ANSI Lip 4 7/8" x 1 1/4"**  
Wood and machine screws are included. Bulk packaged, 1/poly bag. Size: 4 7/8" x 1 1/4"

PLESP-171-C-BULK Chrome

**ENTRY ARMOR — continued**

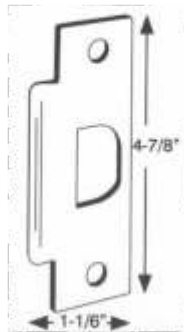

**PLESP-172**

**Strike Plate - Lg Lip 4 7/8" x 1 1/8"**

Covers smaller strike plate holes. Covers damaged wood. Wood & metal screws provided. Size: 4 7/8" x 1 1/8"

PLESP-172-S Stainless

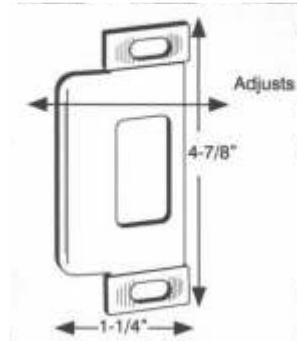

**PLESP-181**

**Strike Plate - Large Adjustable 4 7/8"**

Adjustment allows for a tighter fit of the door to the frame and weather stripping. Size: 4 7/8" x 1 1/4"

PLESP-181-B Brass

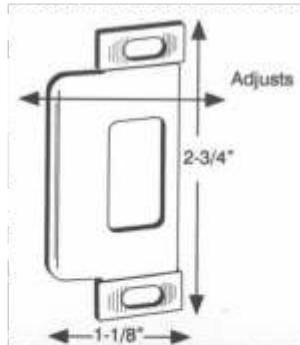

**PLESP-180**

**Strike Plate - Small Adjustable 2 3/4"**

Adjustment allows for a tighter fit of the door to the frame and weather stripping. Size: 2 3/4" x 1 1/8"

PLESP-180-B Brass

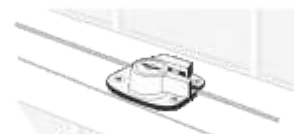

**PLEWL-111**

**Window Lock - Wood Sash Keyed**

Key prevents breaking the glass and easily unlocking the window. Locks and unlocks quickly. 2 keys included.

PLEWL-111-B Brass

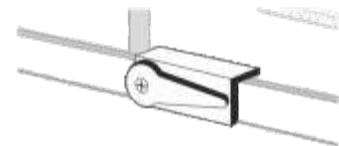

**PLEWL-120**

**Window Lock - Lever**

Easy to use lever. Works on most sliding windows. No tools needed.

PLEWL-120-AL Aluminum

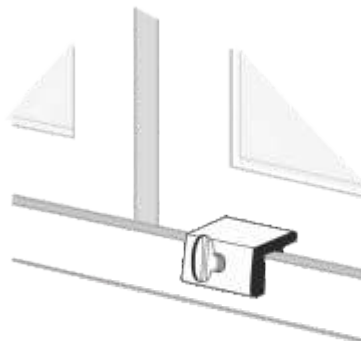

**PLEWL-100**

**Window Lock - Single Wing Nut**

Works on top and bottom tracks. 1 wing nut.

PLEWL-100-AL Aluminum

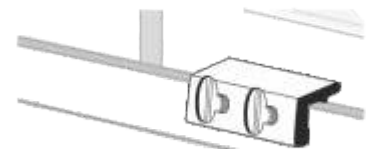

**PLEWL-150**

**Window Lock - Double Wing Nut**

Works on top and bottom tracks. 2 wing nuts.

PLEWL-150-AL Aluminum

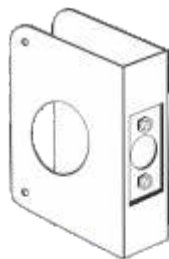

- EWP-121
- EWP-123
- EWP-131
- EWP-133
- EWP-134

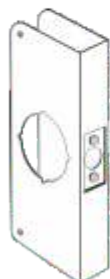

PRODUCT NUMBER	HOLE SIZE	BACK SET	DOOR THICKNESS	OVERALL SIZE	FINISH
<b>1-1/2" Hole Size</b>					
PLEWP-100-S	1 1/2"	2 3/8"	1 3/8"	4" x 4 1/2"	Stainless
PLEWP-101-S	1 1/2"	2 3/8"	1 3/8"	4" x 4 1/2"	Stainless
PLEWP-110-S	1 1/2"	2 3/8"	1 3/8"	4 3/8" x 4 1/2"	Stainless
PLEWP-111-S	1 1/2"	2 3/8"	1 3/8"	4 3/8" x 4 1/2"	Stainless
<b>2-1/8" Hole Size</b>					
PLEWP-120-S	2 1/8"	2 3/8"	1 3/8"	4" x 4 1/2"	Stainless
PLEWP-121-S	2 1/8"	2 3/8"	1 3/8"	4" x 9"	Stainless
PLEWP-122-S	2 1/8"	2 3/8"	1 3/8"	4" x 4 1/2"	Stainless
PLEWP-123-S	2 1/8"	2 3/8"	1 3/8"	4" x 9"	Stainless
PLEWP-124-S	2 1/8"	2 3/8"	1 3/8"	5" x 20"	Stainless
PLEWP-130-S	2 1/8"	2 3/8"	1 3/8"	4 1/4" x 4 1/2"	Stainless



## ENTRY ARMOR — continued

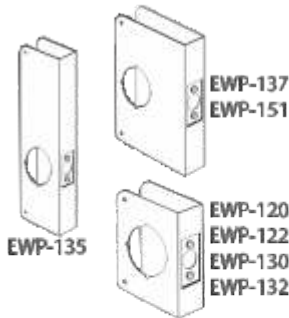

PRODUCT NUMBER	HOLE SIZE	BACK SET	DOOR THICKNESS	OVERALL SIZE	FINISH
<b>PLEWP-131-S</b>	2 1/8"	2 3/4"	1 3/8"	4 1/4" x 9"	Stainless
<b>PLEWP-132-S</b>	2 1/8"	2 3/4"	1 3/8"	4 1/4" x 4 1/2"	Stainless
<b>PLEWP-133-S</b>	2 1/8"	2 3/4"	1 3/8"	4 1/4" x 9"	Stainless
<b>PLEWP-134-S</b>	2 1/8"	2 3/4"	1 3/8"	5" x 12"	Stainless
<b>PLEWP-135-S</b>	2 1/8"	2 3/4"	1 3/8"	5" x 14"	Stainless
<b>PLEWP-136-S</b>	2 1/8"	2 3/4"	1 3/8"	5" x 20"	Stainless
<b>PLEWP-137-S</b>	2 1/8"	2 3/4"	1 3/8"	6 1/2" x 9"	Stainless
<b>PLEWP-151-S</b>	2 1/8"	5"	1 3/8"	6 1/2" x 9"	Stainless

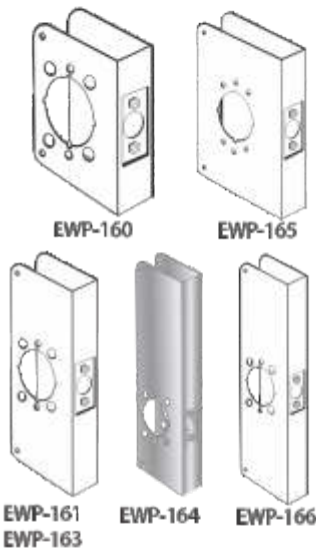

PRODUCT NUMBER	HOLE SIZE	BACK SET	DOOR THICKNESS	OVERALL SIZE	FINISH
<b>ADA Levers - 2 1/8" Hole Size</b>					
<b>PLEWP-160-S</b>	2 1/8"	2 3/4"	1 3/8"	4 3/4" x 4 1/2"	Stainless
<b>PLEWP-161-S</b>	2 1/8"	2 3/4"	1 3/8"	4 3/8" x 9"	Stainless
<b>PLEWP-163-S</b>	2 1/8"	2 3/4"	1 3/8"	4 3/4" x 12"	Stainless
<b>PLEWP-164-S</b>	2 1/8"	2 3/4"	1 3/8"	5" x 14"	Stainless
<b>PLEWP-165-S</b>	2 1/8"	2 3/4"	1 3/8"	6 1/2" x 9"	Stainless
<b>PLEWP-166-S</b>	2 1/8"	2 3/4"	1 3/8"	5 3/8" x 20"	Stainless

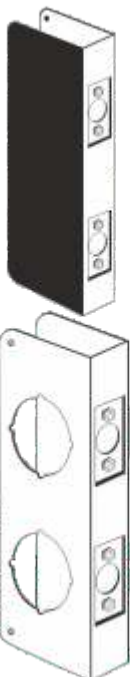

PRODUCT NUMBER	HOLE SIZE	BACK SET	DOOR THICKNESS	OVERALL SIZE	FINISH
<b>1 1/2" Top Hole Size, 2 1/8" Bottom Hole Size</b>					
<b>PLEWP-200-S</b>	4"	2 3/8"	1 3/8"	4" x 9"	Stainless
<b>PLEWP-201-S</b>	4"	2 3/8"	1 3/8"	4" x 9"	Stainless
<b>PLEWP-210-S</b>	4"	2 3/4"	1 3/8"	4 1/4" x 9"	Stainless
<b>PLEWP-211-S</b>	6"	2 3/4"	1 3/8"	4 1/4" x 12"	Stainless
<b>2 1/2" Top Hole Size, 2 1/8" Bottom Hole Size</b>					
<b>PLEWP-220-S</b>	3 3/8"	2 3/8"	1 3/8"	4" x 9"	Stainless
<b>PLEWP-221-S</b>	3 3/8"	2 3/8"	1 3/8"	4" x 9"	Stainless
<b>PLEWP-222-S</b>	4"	2 3/8"	1 3/8"	4" x 9"	Stainless
<b>PLEWP-223-S</b>	5 1/2"	2 3/8"	1 3/8"	4" x 12"	Stainless
<b>PLEWP-225-S</b>	3 3/8"	2 3/4"	1 3/8"	4 1/4" x 9"	Stainless
<b>PLEWP-226-S</b>	4"	2 3/4"	1 3/8"	4 1/4" x 9"	Stainless
<b>PLEWP-227-S</b>	5 1/2"	2 3/4"	1 3/8"	4 1/4" x 12"	Stainless
<b>PLEWP-228-S</b>	6"	2 3/4"	1 3/8"	4 1/4" x 12"	Stainless

**ENTRY ARMOR — continued**

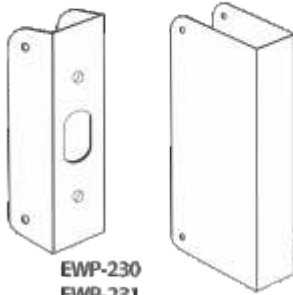

EWP-230  
EWP-231

PRODUCT NUMBER	HOLE SIZE	BACK SET	DOOR THICKNESS	OVERALL SIZE	FINISH
<b>Edge Guards</b>					
<b>PLEWP-230-S</b>	-	-	1 3/4"	4 1/2" x 1"	Stainless
<b>PLEWP-231-S</b>	-	-	1 3/4"	4 1/2" x 1"	Stainless
<b>PLEWP-232-S</b>	-	-	1 3/4"	12" x 1"	Stainless
<b>PLEWP-250-S</b>	-	-	1 3/4"	5" x 12"	Stainless
<b>PLEWP-251-S</b>	-	-	1 3/4"	5" x 12"	Stainless
<b>PLEWP-252-S</b>	-	-	1 3/4"	5" x 12"	Stainless

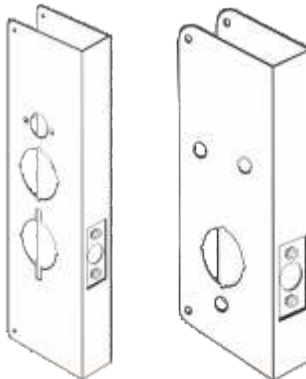

EWP-300      EWP-500

PRODUCT NUMBER	HOLE SIZE	BACK SET	DOOR THICKNESS	OVERALL SIZE	FINISH
<b>Blank Wrap Plates w/ Trim Screws</b>					
<b>PLEWP-290-S</b>	-	-	1 3/4"	4 1/4" x 4 1/2"	Stainless
<b>PLEWP-291-S</b>	-	-	1 3/4"	4 1/4" x 4 1/2"	Stainless
<b>PLEWP-292-S</b>	-	-	1 3/4"	4 1/4" x 9"	Stainless
<b>PLEWP-293-S</b>	-	-	1 3/4"	4 1/4" x 9"	Stainless
<b>PLEWP-294-S</b>	-	-	1 3/4"	5" x 12"	Stainless
<b>PLEWP-295-S</b>	-	-	1 3/4"	5" x 20"	Stainless

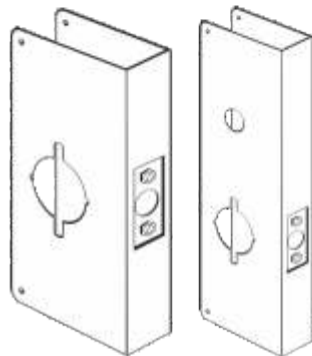

EWP-541      EWP-542

PRODUCT NUMBER	DESCRIPTION	OVERALL SIZE	FINISH
<b>Specialty Wrap Plates Applications</b>			
<b>PLEWP-300-S</b>	<i>Alarm Lock T2/T3</i>	5" x 14"	Stainless
<b>PLEWP-320-S</b>	<i>Best 93K</i>	5 1/2" x 12 1/2"	Stainless
<b>PLEWP-500-S</b>	<i>E-Plex 2000</i>	5" x 14"	Stainless
<b>PLEWP-541-S</b>	<i>Medeco and Marks Levers</i>	4 3/4" x 5 1/2"	Stainless
<b>PLEWP-542-S</b>	<i>Marks I-Q</i>	5" x 15"	Stainless
<b>PLEWP-660-S</b>	<i>Simplex 9"</i>	5" x 9"	Stainless
<b>PLEWP-661-S</b>	<i>Simplex 14"</i>	5" x 14"	Stainless
<b>PLEWP-670-S</b>	<i>Sargent 6500 Series 5.5"</i>	4 3/4" x 5 1/2"	Stainless
<b>PLEWP-671-S</b>	<i>Sargent 6500 Series 9"</i>	4 3/4" x 9"	Stainless
<b>PLEWP-680-S</b>	<i>Schlage Cobra 12"</i>	5" x 12"	Stainless
<b>PLEWP-681-S</b>	<i>Schlage Cobra 14"</i>	5" x 14"	Stainless

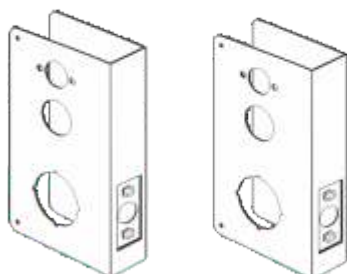

EWP-660      EWP-661



EWP-670

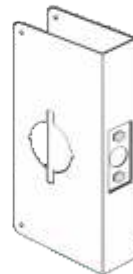

EWP-671

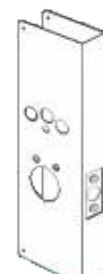

EWP-680



EWP-681

**ELECTRIC STRIKES**



**F2 SERIES**

*Features:*

- Fail Secure
- 3 hour fire rating
- Wood, metal, aluminum frames
- Modular design allows compatibility with most locks - no special faceplates required
- Accommodates up to 3/4" latch projection
- 12/24 DC/AC

RCF2164-630



**RIM STRIKE** *Commercial grade 2*

*Features:*

- Fail Secure
- 1 3/4" x 9"
- Wood / Metal / Aluminum Frames
- Accommodates 1/2" to 3/4"
- Works with most manufacturer's exit devices
- 24VAC/DC

RC0161-08-32D



**Rim Device Strike**

*Features:*

- Compatible with most major manufacturers
- Stainless steel
- Dual voltage for flexibility in the field, plug-in wire connectors up to 1/4" horizontal adjustment

RC0162-32D 3/4"

RC0563-32D 1/2"



**Economy Strikes Light Duty**  
*Offset & Centerline Latch Entry*

*Features:*

- 3/8" Latch Projection
- 1 1/4" x 5 3/8"
- Fail Secure
- For hollow metal, aluminum or wood frames

RC15BS-01-26D *Brushed Chrome*

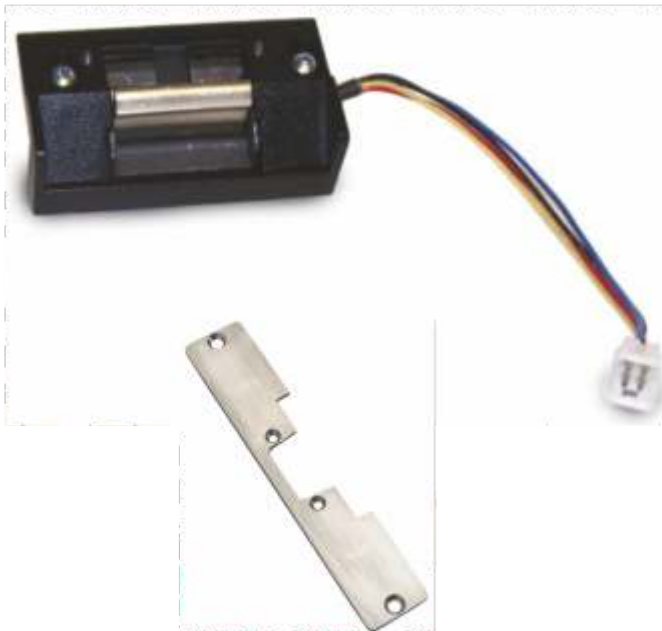

**"All-in-one" 6 Series Electric Strike**

*Features:*

- Field selectable fail safe or secure with the turn of a dial (Fail unlocked requires DC)
- Field selectable voltage 12 or 24VDC and 12 to 24VAC (even 16VAC)
- Low profile version is shallow enough for use with narrow stile aluminum frames (only 1 3/16" deep)
- Horizontal adjustability (up to 1/8")
- Modular "plug-in" wire connectors for fast hook-up
- Modular faceplate designs for a variety of frame types and cut outs
- L6514 Low Profile version 3/8" latch projection
- S6514 Standard version 3/4" latch projection

RCAL65 Low Profile Strike Less Faceplate

RCAS65 Standard Profile Strike Less Faceplate

**Faceplate Options**

**1 1/4" x 4 7/8" Round Corner**

RCB6-04-32D

**1 1/4" x 6 7/8" Round Corner**

RCB6-07-32D

**1 1/4" x 4 7/8" Square Corner**

RCB6-14-32D

**1 3/8" x 7 15/16" Round Corner**

RCB6-08-32D



**7 SERIES**

**MODEL #7104**

Commercial Grade 3, use w/aluminum frames



*Features:*

- Face Plate - 1 1/4" x 4 3/8"
- Keeper Depth - 5/8"
- Case Depth - 1 1/2"
- Fail Locked

RC7104-01-32D	11-16VAC
RC7104-05D-32D	12VDC
RC7104-07-32D	24VAC
RC7104-08D-32D	24VDC

**MODEL #7108**

Commercial Grade 3, use w/alum. or wood frames



*Features:*

- Face Plate - 1 7/16" x 7 9/16"
- Keeper Depth - 5/8"
- Case Depth - 1 1/2"
- Fail Locked

RC7108-01-32D	11-16VAC
RC7108-05D-32D	12VDC
RC7108-08D-32D	24VDC

**MODEL #7114**

Commercial Grade 3, use with hollow metal frames



*Features:*

- Face Plate - 1 1/4" x 4 3/8"
- Keeper Depth - 5/8"
- Case Depth - 1 1/2"
- Fail Locked

RC7114-01-32D	11-16VAC
RC7114-05D-32D	12VDC
RC7114-07-32D	24VAC
RC7114-08D-32D	24VDC



RC12C-06-32D	COMPACT STRIKE 12VDC
RCA71-12VDC	71 SERIES WITHOUT FACEPLATE
RCA71-16VAC	71 SERIES WITHOUT FACEPLATE
RCA71-24VDC	71 SERIES WITHOUT FACEPLATE

**CABINET LOCKS**

**3 Series Commercial Grade**

*Features:*

- Self-adjusting alignment tabs
- Side or top mounting capabilities
- Four countersunk mounting holes



RC3513	12/24DC Black Finish
RC3513DM	Dual Monitoring

**ACCESSORIES**

**TRANSFORMERS**

RCRT1002	12AC
RCRT1008	24AC



**POWER SUPPLY**

**RT1003**



Batteries & Timer For 10-5 Power Supply

*FEATURES:*

- 2 momentary or latching relays to control devices
- Large alphanumeric backlit LCD display
- EEPROM Memory for safe storage of data (all data is stored in the event of a power failure)
- 40 programmable holidays
- 99 Daily/Weekly events
- Automatic Voltage 12 to 24 VAC or DC
- Built in battery charger circuit

RC RT1003 Plug-in 12DC 1.5 Amp

## SWITCHES

### 909 Series Rocket Switch



**Features:**

- Momentary Rocker Switch, SPDT
- 10 amp @ 250 Volt
- 2 3/8" x 2 3/4" x 9/16"
- Surface Mounted

RC909-MO

### 980 Series Push Button Switch



**Features:**

- Face Plate - 2 3/8" x 4 1/2"
- Momentary SPDT
- 4 amp @ 250 Volt

RC980-MO-32D

### 960 Series Key Switch



NOTE: Cylinder Not Included

**Features:**

- Face Plate: 960 - 3" x 4 3/4"
- 960N - 1 5/8" x 4 3/4"
- 5 amp @ 120 Volt.
- LED (Red/Green) Mounted in Plate

RC960-MA-LED-28 Maintained SPDT- ON/OFF

RC960-MO-LED-28 Momentary SPDT- NO & NC

## LOOPS

### Flex Loop

**FEATURES:**

- Surface Mounted
- Stainless Steel cable
- Plastic end caps
- 9507- Accepts up to 4 conductor @ 22 ga. or 2 conductor @ 18 ga
- 9508- Accepts up to 16 conductor @ 22 ga. or 8 conductor @ 18 ga



- RC9507-12B 12" Brown
- RC9507-12S 12" Silver
- RC9507-18B 18" Brown
- RC9507-18S 18" Silver
- RC9507-7S 7" Silver
- RC9509-18S 18" Silver

## EXIT DEVICES

### High Security Exit Devices

**FEATURES:**

- Interlocking latch and strike grip completely encased within the mechanism
- Virtually impossible to pry or force open
- Gentle push on the exit bar releases the latch



RC1200C-36"-28 Cyl. Dogging Alum

## PUSH BUTTON

### Illuminated Pushbutton

**Features:**

- SPDT momentary switch illuminated by your choice of incandescent or LED bulbs in 12V and 24V
- Mounts on a stainless steel single gang faceplate



RC972-L-ES-MO

**MAGNETS**

**8310 MultiMag**

For Single Outswinging Interior or Perimeter Doors



- Features:**
- Adjustable keyhole mounting
  - Convenient plug-in wiring terminals
  - Built-in delayed relock feature (0-110 seconds)
  - Field selectable voltage 12/24VDC
  - Up to 1500 lbs. (680 kg.) holding force
  - Easy-access wiring cavity
  - Stabilizing 4-bolt "Drop-Stop" mounting
  - Low-voltage detection
  - Self-drilling tek™ fasteners
  - MOV surge protection
  - 1 3/4"D x 2 3/4"W x 10 1/2"L

RC8310-28  
RC8310-28-SCS

**8320 MultiMag**

For Double Outswinging Interior or Perimeter Doors



RC8320-28

- Features:**
- Adjustable keyhole 8-bolt "Drop-Stop" mounting
  - Convenient plug-in wiring terminals
  - Field selectable voltage 12/24VDC
  - 1500 lbs. holding force ea. electromagnet
  - Easy-access wiring cavity
  - Self-drilling tek™ fasteners
  - MOV surge protection
  - 1 3/4"D x 2 3/4"W x 21"L

**8371 Surface MiniMag**

For Single Outswinging Interior Doors



- Features:**
- Low-profile design
  - Field-selectable voltage 12/24VDC
  - Up to 750 lbs. (340kg.) holding force
  - No residual magnetism
  - Hardened steel armature nut
  - 1"D x 1 1/2"W x 9 3/4"L

RC8371-28  
RC8371-28-SCS

**8375 Surface MicroMag**

For Swinging Doors on Small Enclosures



- Features:**
- Up to 300 lbs. (136kg.) holding force
  - Low energy consumption
  - Field-selectable voltage 12/24VDC
  - MOV surge protection
  - Hardened steel armature nut
  - 3/8"D x 1 1/2"W x 6 3/8"L

RC8375-28

**8380 GateMag**

For Single or Double Swinging or Sliding Interior or Exterior Gates



RC8380-32D

- Features:**
- No residual magnetism
  - Weather-resistant
  - Stainless steel housing
  - Versatile face or bottom mounting
  - Built-in RLS (Remote Lock Status)
  - Field-selectable voltage - 12/24VDC
  - 6 1/2' (1.9 meters) wire cable
  - Up to 1500 lbs. (680kg.) holding force
  - Conduit fitting inside diameter 1/2"
  - Conduit fitting outside diameter 3/4"
  - MOV surge protection
  - Low energy consumption
  - 1 3/4"D x 2 1/2"W x 8 3/4"L

**DE8310 Delayed Egress**

For Single Outswinging Perimeter Doors



RCDE8310-28  
RCDE8310S-28

- Features:**
- Field selectable 15 or 30 second release delay with field selectable 0 to 3 second nuisance delay
  - Highly visible "Red/Green" light panel indicates status of door (local)
  - Includes 960 Keypad for reset and override, 15 second Building Code Sign; base unit includes external sounder
  - Built-in Security Condition Sensor (SCS) feature indicates that the door is closed and bonded
  - Dry contact relay switching (SPDT and DPDT) provided for local and/or remote monitoring
  - Auto sensing voltage from 12 to 30 VDC
  - Up to 1200lbs (540kg) holding force

**Angle Bracket**

For 8310

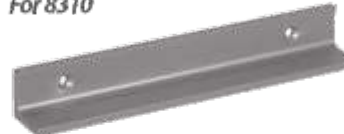

- Features:**
- Dimensions: 1" x 1" x 10 1/2"
- RCAB-01-28

**Top Jamb Z Bracket**



RCTJ71-28 For 8371  
RCTJ75-28 For 8375

**Top Jamb Z Bracket**



RCTJ80-28 For 8380

**LEGEND**

<b>SCS</b>	Security Condition Sensor
<b>LSS</b>	Lock Status Sensor

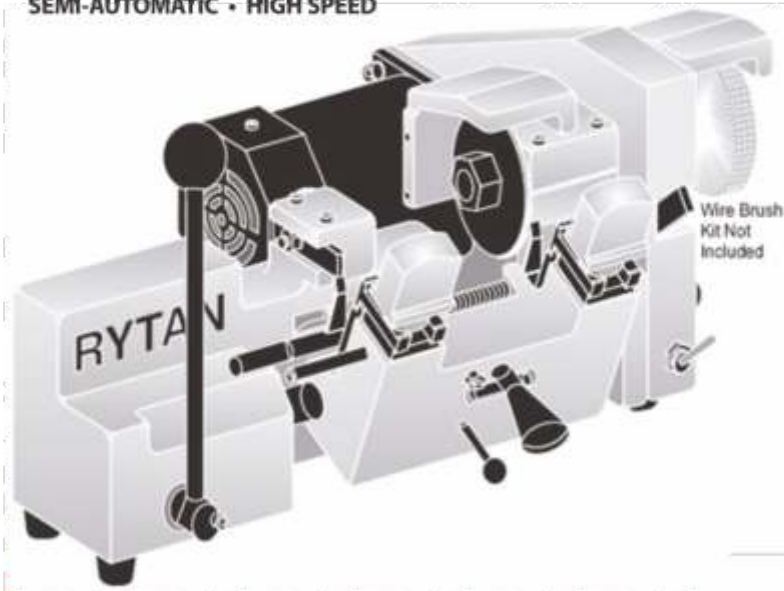

## KEY MACHINE

**SEMI-AUTOMATIC • HIGH SPEED**

### RY100 Universal Semi-Automatic Key Duplicating Machine

*Quick Change top vise jaws- Vises flip over for extra deep cuts only. One cutter cuts all cylinder keys. Built-in full function key gauging; top shoulder gauge standard keys, tip gauge keys such as Best & Falcon, behind the tip such as Best & Falcon.*

RYRY100 Key Machine  
RYRY101 Wire Brush - All Machines



**RYRY10030 STANDARD CUTTER**  
(HSS/M3) FITS RY45 RY100 RY256

RYRY10030 Cutter



### RY57 Plug Spinner

RYRY57 Plug Spinner  
RYRY57RB Replacement Blades

## LOCK LUBRICANT

### Poxylube Spray 4.5 oz.

*Each can comes with plastic needle*



#### Typical Uses:

- Retard and resist corrosion
- Prevent seizure
- Tough dry film clings to all metallic and non-metallic surfaces and is not affected by water or normal temperature fluctuations
- Stainless steel spray needle is available for those hard to reach areas

PXDFL-L200-C02-AA4 4.5oz Spray  
PX2400-060-ZZ1 Spray Needle, Stainless Steel

**6730 SERIES**

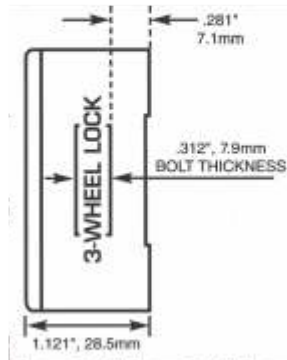
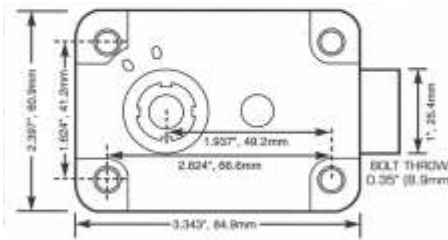

**Complete Locks - Large Knob  
6730 Group 2 - Front Reading - B&W**

Each lock, dial, and ring is packaged in an individual box, complete with change key, instructions and all hardware necessary for a standard mounting.

- SG6730-100 D300/R211
- SG6730-103 D690/R211 Key Locking
- SG6730-010 6730 Group 2 - Lock Only

**6700 Series - PARTS**

- |                    |                          |
|--------------------|--------------------------|
| SGU17              | Spline Key               |
| SG6730-003-140-000 | Bolt, Extra Long         |
| SG7112-001         | Cylinder, Pin Tumbler    |
| SG7312-001         | Spindle, Extension Kit   |
| SG7600-003         | Dial Insert, Key Locking |
| SG7600-004         | Dial Insert              |
| SG7600-005         | Cylinder, Wafer          |



7312-001



7600-005



U17



6730-003-140-000



7600-003



7600-004

**6700 SERIES DIALS**



**SGD003-003**  
Front Reading  
Spindle: 5/16 - 40"  
Use with dial ring:  
R004 Dia. 2.943

**SGD017-007**  
Front Reading - Spindle: 5/16 - 40"  
Use with dial ring: R0344 Dia. 2 7/8"



**SGD112-004**  
Spy-Proof  
Spindle: 5/16 - 40"  
Use with dial ring:  
R162 Dia. 2.907"  
Regular Change

SGD003-003 Front Reading  
SGD112-004 Spy-Proof

**6700 SERIES DIAL RINGS**



**SGR004-002**  
Front Reading - Regular Change  
Diameter: 3 3/4"  
Use with dial: D003 & D035



**SGR162-002**  
Spy-Proof  
Used with dial: D112 - Regular Change

SGR004-002 Front Reading  
SGR162-002 Spy-Proof

## CONVERTIBLE DIALS & RINGS

### CONVERTIBLE FRONT READING DIAL

The non-keylocking convertible dials can be used with existing dial rings but the keylocking convertible dials must be used with the new type dial rings.

Keylocking convertible dials can be either key removable locked only (option) or key removable locked and unlocked (standard). A keylocking dial can be modified in the field to key removable locked only by staking a rivet supplied by Sargent & Greenleaf, Inc. into the back of the dial.

The overall diameter and the height from the door surface are the same as current dial and ring sets. The attaching screw holes locations are also the same.

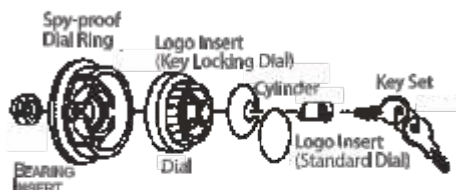

#### Dials - Spy Proof - Use with R167 Ring

SGD220-014	B&W
SGD220-017	Satin Chrome
SGD225-008	B&W
SGD225-014	Satin Chrome

#### Dials - Front Read - Use with R211 Ring

SGD300-018	B&W
SGD690-009	B&W

#### Rings - 3.743" Diameter

SGR167-002	Spy Proof B&W
SGR167-014	Spy Proof Satin Chrome

#### Rings - 3.750" Diameter

SGR211-002	Front Read B&W
------------	----------------



**D220-014**



**D225-014**



**R211-002**



**D690-009**

## MODEL 6120 ELECTRONIC SAFE LOCK



- SG6120-014 Keypad 6120/21 Matte B/W**
- SG6120-016 Keypad 6120/21 Sat Chrome**
- SG6120-305 Electronic Lock**
- SG6120-309 Electronic Lock Only**

#### Features:

- One million codes to choose from, one master code and eight user codes, capable of a management reset code. Programmable time delay of one to nine minutes can easily be activated from the keypad.
- Penalty lockout feature shuts the lock down for five minutes of four or more incorrect codes are entered in a row to deter random code entry attempts.
- All programming is accomplished via the keypad; no special programming tools required.
- Deadlocking, motor driven bolt withstands over 225 lbs. of end pressure. Also available in spring latch version for container doors without boltwork.
- All programming is accomplished via the keypad; no special programming tools required.
- Deadlocking, solenoid blocked bolt withstands over 225 lbs. of end pressure. Also available in spring latch version for container doors without boltwork.
- Uses S&G's Magic Module® footprint to match the mounting dimensions of most mechanical and electronic safe locks.
- Can be used with either a one-battery or two-battery keypad. Time Delay Status Indicator (to provide remote viewing of time delay status), Spy-Proof Keypad Cover (to prevent bystanders from seeing the code you enter), Time Commander II (a full-function time lock with repeating seven day schedule).



**SAFE DEPOSIT LOCKS**

**8560MP LOCKS**

The **4440** is a double horn (nose), non-changeable lock designed to provide simple, inexpensive deposit box security. Features an 11 lever construction (six renters, five guard) for optimum protection against unauthorized entry.

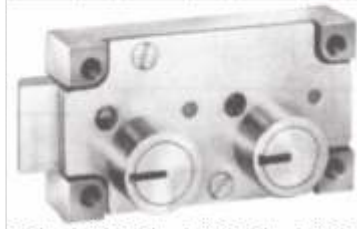

- SG4440-018 Left Hand
- SG4440-070 Right Hand
- SG9500-001 Guard Key Blank
- SG9500-003 Renters Key Blank

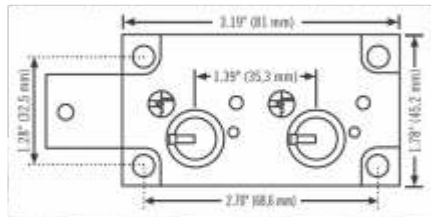

The **4444** lock is designed as the primary lock for B and C-rate depository safes and for inner compartment doors. It incorporates special burglary resistant features. Its bolt is drilled and tapped for an 8-32 machine screw to accommodate boltwork attachment.

- SG4444-002 Long Bolt

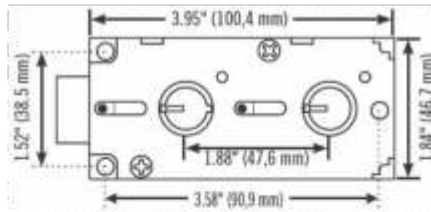

The centerline design of the **4500 Series** allows the same lock to be mounted either left-handed or right-handed.

- SG4544-020 Double-Changeable 3/8" Nose
- SG4545-004 Double-Changeable 1/2" Nose
- SG4565-004 Fixed-Fixed 1/2" Nose
- SG9500-055 (Cut BA4) Guard Key - Not Included w/lock

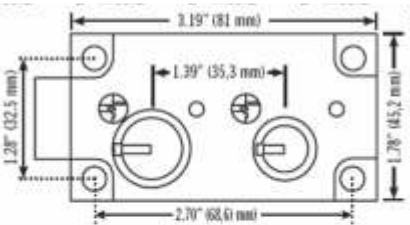

The **4442** is a double horn (nose), non-changeable lock designed to match the appearance of the Diebold 175 Series safe deposit lock. It is essentially the same lock as the 4440 model with a different cover style. It features a large-small nose construction with a renters nose diameter of .84" and a guard side nose diameter of .67".

- SG4442-004 Left Hand
- SG4442-014 Right Hand
- SG9500-001 Guard Key Blank

**Complete with Dial and Ring**

**One Million Combinations**

The **8550 Series** includes several variations of a three-wheel combination lock. They offer one-hand operation and come in right-hand, vertical up & vertical down applications. Their standard wheels are brass. These locks allow the choice of up to one million different combinations which can be easily changed by key.

**Relocking Feature**

As an extra security feature, all 8550 models are equipped with a special relock trigger which automatically secures the lock if the spindle is punched. A thermal relock device also protects against entry by the application of heat.

**Torque Adjustment**

A feature of the 8550 Series is torque adjustment. Friction in the wheelpack of combination locks makes the dial hard to turn. This feature makes it possible to adjust dialing torque to individual touch with the use of a allen wrench. This feature adds security by enabling torque pressure to be applied to the wheelpack.



**SG 8560-100 Group 1R**

SG8560-100

MP Lock

**PARTS**

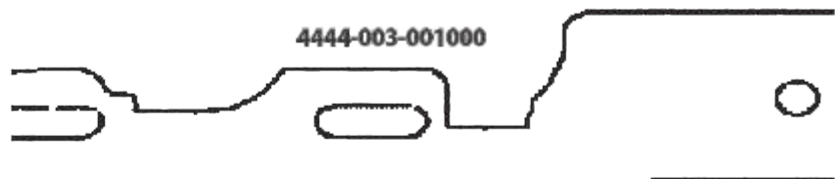

4444-003-001000

SG4444-003-001000

Bolt



SG9500-026(Code AA4) Cut Guard Key 4400 Series

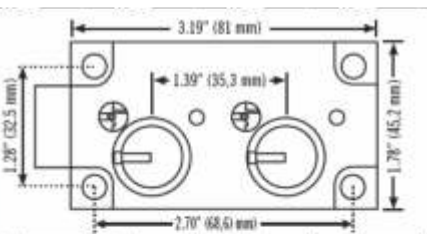

The **4443** is a double horn (nose), non-changeable lock designed to match the appearance of the Mosler 5700 Series safe deposit lock. It is identical to the 4440 unit in features and options. The only difference is its cover style. It features a double-large nose construction with both the renters and guard side having .82" diameters.

- SG4443-008 Left Hand
- SG4443-028 Right Hand
- SG9500-027 (Cut Guard Key BA4)

## KEY-OP LOCKS

This key lock is an identical retrofit to our standard "Magic Module" family of locks. The mounts and matches installations of our combination lock (6700, 8400, 8500) series and our high security European changeable key lock. It is a blend of security and convenience features to provide the right balance of performance and price for inner compartment and outer safe doors, furniture, filing and office equipment.

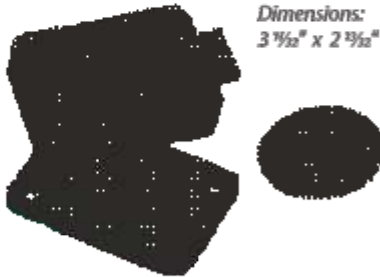

Dimensions:  
3 7/32" x 2 3/32" x 1 7/64"

The lock is changeable, using a standard readily available "Allen" or hex wrench. There are seven levers with false gates to provide pick resistance equal to locks used in safe depositories. The lever stack forms an internal shroud around the key so that the lock is difficult, perhaps impossible, to "read" with all the modern optical burglary tools. The changeable keys give you and your customer great flexibility and integrity of security.



SG6804-049 Key Retaining

## TITAN LOCKS

### FEATURES

- Reliable, secure motor actuated locking mechanism.
- One million codes to choose from.
- Field programmable (via keypad) for single control, and employee/manager modes; changeable at any time.
- Default operating mode is single control, but the lock can easily be set to a permanent dual control mode.
- One master code, one supervisor code, one time delay override code, seven user codes (eight user codes if time delay override is not enabled).
- Factory programmed Management Reset Code can be changed to an MRC of your own choosing during the initial lock setup (MRC is not available if the lock is set to dual control mode).
- Programmable time delay of one to ninety-nine minutes can easily be programmed and activated from the keypad.
- Time delay opening window can be set from one to fifteen minutes.
- Penalty lockout feature shuts the lock down for five minutes if four or more incorrect codes are entered in a row to deter random code entry attempts.
- All programming is accomplished via the keypad; no special programming tools required.
- Deadlocking, solenoid blocked bolt withstands over 225 lbs. of end pressure.
- Uses S&G's "Magic Module" footprint to match the mounting dimensions of most mechanical and electronic locks.
- The Titan PivotBolt & Direct Drive are reversible and can be mounted RH, LH, VU, and VD with no alterations.
- Low profile keypad is only 1" (25.4 mm) high, and is 3 3/8" (9.5 cm) in diameter.



Titan D-Drive

- SG2006-108 Titan Pivot Bolt
- SG2006-112 Titan Pivot Bolt Brass
- SG2007-102 Titan Direct Drive



**SARGENT**  
**ASSA ABLOY**

# Master the ins and outs of security



80 Series Exit Device

Door hardware that  
takes security as  
seriously as you do

11 Line Bored Lock



8200 Series  
Mortise Lock



IN120  
WiFi Access  
Control Lock



Be in control of your facility's hardware, not constrained by it. SARGENT expands your building's security by offering a wide variety of strong, flexible ANSI/BHMA Grade 1 door hardware. Maintenance is simple and security level changes are seamless. Start every day knowing you have complete command of your facility's security with SARGENT.

Visit [www.sargentlock.com](http://www.sargentlock.com) for more information.

**BHMA**  
CERTIFIED



**6-LINE**

**Entrance or Office**



- Features:**
- Retract latchbolt by either knob unless outside knob is locked by turn button in inside knob
  - Turn button must be released manually
  - For Doors 1 3/8" to 1 3/4" thick
  - Backset 2 3/4", ASA Strike
  - Key retracts latch bolt when outside knob is locked
  - 6 Pin LA Cylinder Included

SA2428-6G05-OB-10B  
SA2428-6G05-BS-260  
SA2428-6G05-OB-260

- Finishes:**
- US10B - Dark Bronze
  - US26D - Dull Chrome



SA06-5083-32D  
2 3/8" BS 2 1/4" x 1 1/4" Front

**6 LINE PARTS**

SA13-0205 Retainer Clip, 6 Line  
SA13-0908 Tailpiece, 6 Line

**Deadlocking Latches - Guarded**

SA07-2430-32D 2 3/4"  
SA07-2431-32D 2 3/8"  
SA07-2432-32D Unguarded 2 3/4"



**10-LINE**

**Heavy Duty Commercial Levers**



- Features:**
- For Doors 1 3/4" thick
  - Backset 2 3/4"
  - Steel with zinc dichromate finish and stainless steel cylindrical housing
  - Stainless steel latch, 1/2" throw
  - 6 Pin, LA Keyway, Brass Cylinder, accepts Schlage cylinder (not included)
  - UL Listed for 3 Hour Doors

**Privacy (Latchbolt by either lever)**



SA28-10U65-LL-26D

**Store Room or Service**

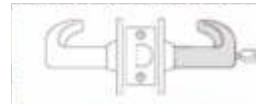

Deadlocking latch, latch bolt by lever inside or key outside, outside lever right at all times.

SA28-10G04-LL-26D



**Office / Entry Lock**

G1 2 3/4" BACKSET 6-PIN LA

SA28-10G05-LL-26D

**Classroom**

Deadlocking latch, latch bolt by either lever unless outside outside lever is locked by key, key in outside lever locks or unlocks outside lever. Inside lever always operative.



SA28-10G37-LL-26D

**10 Line Parts**

SA10-3192-32D Deadlatch, 2 3/4" BS  
SA13-0895 Tailpiece, 10 Line  
SA13-3257 Body & Slide assy. 10L

**11-LINE**



**Features:**  
 • For high traffic doors  
 • Fewer parts for easier installation  
 • Only 45 degrees of lever rotation required to retract latchbolt  
 • 19 functions. Many functions are easily field changeable

SA2830-11G05-LL-26D OFFICE  
 SA2870-11G04-LL-26D STOREROOM  
 SA2870-11G05-LL-26D OFFICE  
 SA2870-11G38-LL-26D CLASSROOM SECURITY  
 SA28LC-11G04-LL-26D STOREROOM  
 SA28LC-11G05-LL-26D OFFICE

LC-11G04-LL-26D  
 Storeroom/Closet T-Zone

LC-11G05-LL-26D  
 Entry / Office T-Zone

LESS SCHLAGE CYLINDER  
 IC DISPOSABLE CORE  
 IC DISPOSABLE CORE  
 IC PREP  
 L/SARGENT CYLINDER  
 LESS SARGENT CYLINDER

**8200 MORTISE LOCKS**



**Features:**  
 • Security Grade 1  
 • Heavy duty wrought steel hubs and high carbon steel spring cartridge  
 • 3/4" stainless steel latch throw  
 • One piece construction to offer 1" total bearing surface against the strike  
 • 1" throw stainless steel deadbolt with 2 hardened steel rollers  
 • 10 Year mechanical warranty. No service required to maintain warranty

SA8205-LNL-US26D Office/Entry  
 SA8215-LW1L-US26D Passage  
 SA8265-LW1L-US26D Privacy  
 SABP-8205-US26D Lockbody Only  
 SALC-8204-LW1L-US26D Storeroom  
 SALC-8205-LW1L-US26D Office

SALC-8255-LW1L-US26D Mortise-Office/Entry  
 SALC-8205-LB-US26D Ofce Mortise Lock  
 SALC-8205-WTL-US26D Ofce Mortise Lock

**KEYPAD**

**Keypad Mortise Lock**



SAKP8276-LNJ-US26-LH Bright Chrome

**8888 EXIT DEVICE**



**8888 Rim Exit Device**  
**Features:**  
 • Grade 1  
 • Chassis Cover: cold drawn brass, bronze or stainless steel  
 • Nonferrous alloy chassis Allen-type dogging furnished standard  
 • Stainless steel latchbolt, 3/4" throw  
 • 641 strike standard

SA12-8888-F-32D  
 SA8888-E-32D  
 SA8888-F-32D  
 SA8888-G-32D  
 SA8888-J-32D

**KEY BLANKS**

SA265-R	SA275-LK	SA278-CA	SA6275-HB	SA6275-RC
SA265-U	SA275-LL	SA6265-R	SA6275-LA	SA6275-RE
SA270-LN	SA275-RA	SA6265-U	SA6275-LB	SA6275-RF
SA270-RH	SA275-RB	SA6270-LD	SA6275-LC	SA6275-RG
SA270-RN	SA275-RC	SA6270-LH	SA6275-LE	SA6275-RJ
SA275-LA	SA275-RE	SA6270-LM	SA6275-LF	SA6275-RK
SA275-LB	SA275-RF	SA6270-LN	SA6275-LG	SA6275-RL
SA275-LC	SA275-RG	SA6270-RD	SA6275-LJ	SA6275-S
SA275-LE	SA275-RJ	SA6270-RH	SA6275-LK	SA6278-CC
SA275-LF	SA275-RK	SA6270-RM	SA6275-LL	
SA275-LG	SA275-RL	SA6270-RN	SA6275-LA	
SA275-LJ	SA275-S	SA6275-HA	SA6275-RB	

**DOOR CLOSER**



**351 Universal**

- Features:*  
 • Heavy duty cast aluminum  
 • ADA compliant door

- SA351-UO-EN  
 SA351-CPSH-EN Door Closer 1-6 Non-handed  
 SA421-CTB-EN Cam Action Closer Pull Side

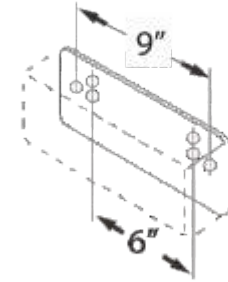

**8400 SERIES**

**Narrow Stile CVR Exit Only**

- SAAD8410-F-LHR-32D-84 33-36" DOOR LESS TRIM  
 SAAD8410-F-RHR-32D-84 33-36" DOOR LESS TRIM

**8500 SERIES**

**Narrow RIM Device Aluminum Door**

- SALC-AD8504-F-ETL-RHR-32D LESS CYLINDER 33-36" DOOR

**8600 SERIES**

**CVR Exit Device Only**

- SAMD-8610-F-LHR-32D-84 33-36" DOOR LESS TRIM  
 SAMD-8610-F-RHR-32D-84 33-36" DOOR LESS TRIM

**8700 SERIES**

- SA12LC-NB8713-F-ETL-LHR-32D WIDE STILE 33-36" x 84" DOOR  
 SA12LC-NB8713-F-ETL-RHR-32D WIDE STILE 33-36" x 84" DOOR  
 SANB-8710-F-LHR-32D-84 33-36" DOOR LESS TRIM  
 SANB-8710-F-RHR-32D-84 33-36" DOOR LESS TRIM

**TRIM**

- SA713-8-ETL-26D-RHR  
 SA715-4-ETL-26D-RHR  
 SA715-8-ETL-26D-RHR  
 SA715-ETL-26D-RHR  
 SA774-8-ETL-26D-RHR-24VDC  
 SALC-704-ETL-26D-RHR  
 SALC-706-4-ETL-26D-RHR  
 SALC-706-8-ETL-26D-RHR  
 SALC-706-ETL-26D-RHR  
 SALC-713-4-ETL-26D-RHR  
 SALC-713-ETL-26D-RHR  
 SALC-777-ETJ-26D-RHR-24VDC

- RIM and NB-SVR DEVICES  
 CVR DEVICES  
 RIM and NB-SVR DEVICES  
 SVR and MORTISE DEVICES  
 NO KEY OVERRIDE  
 NL LEVER TRIM 80 SERIES RIM  
 STOREROOM TRIM 80 SERIES  
 STOREROOM TRIM 80 SERIES RIM  
 STOREROOM TRIM 80 SERIES  
 CLASSROOM TRIM 80 SERIES  
 CLASSROOM TRIM 80 SERIES  
 E-TRIM KP and PROFILE MORT DEV

- KEY LOCKS/UNLOCKS TRIM  
 ACTIVE LEVER NO CYLINDER  
 LEVER RETRACTS LATCH  
 ACTIVE LEVER NO CYLINDER  
 FIELD REVERSIBLE  
 LESS CYLINDER  
 CVR DEVICES - LESS CYLINDER  
 LESS CYLINDER  
 SVR and MORTISE DEVICES  
 CVR DEVICES - LESS CYLINDER  
 SVR and MORTISE DEVICES  
 LESS CYLINDER



**DEADBOLTS**

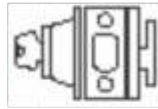





**Single Cylinder Deadbolt**  
SA475-US26D Deadbolt

**CYLINDERS**

**MORTISE CYLINDERS & PARTS**

SA01-1121	Screw (10/PIK)
SA01-0949	Washer Only for Schlage Cyl
SA13-0512	MS Cam
SA13-0664	Standard Cam
SA13-2005-10B	Shell-41 Mort/34 Rim
SA13-2005-26D	Shell-41 Mort/34 Rim
SA13-2006-26D	#42 Shell
SA41-10B-LA	1 1/8" Mort. Cylinder - Std Cam
SA41-26D-LA	1 1/8" Mort. Cylinder - Std Cam

**RIM CYLINDERS & PARTS**

SA13-0074	SA13-2048	9,8 (7 Knob) Cyl Body
SA13-0086	SA13-0074	Connecting Screw
	SA13-0080	Retainer Ring
SA13-0080	SA13-0085	Tailpiece, Flat
	SA13-0086	Mounting Plate
SA13-0085	SA34-US10B	Rim Cylinder - LA
	SA34-26D	Rim Cylinder - LA
		SA13-2048

**PLUGS**

**6-Line Knobs, 6500,  
7-Line,10-Line,  
& 11-Line Levers**



**7 and 8 Line**

SA133142-15-LA	SA133142-15-RB
SA133142-15-LB	SA133142-15-RC
SA133142-15-LC	SA133142-15-RE
SA133142-15-LE	SA133142-15-RG
SA133142-15-LF	SA133142-15-RJ
SA133142-15-LG	SA133142-15-RK
SA133142-15-LJ	SA133142-15-RL
SA133142-15-LK	SA133142-15-S
SA133142-15-LL	SA133142-15-U
SA133142-15-LA	

SA133425-LA-15
SA133425-LC-15
SA133425-LE-15
SA133425-LF-15
SA133425-LG-15
SA133425-LJ-15
SA133425-LK-15
SA133425-LL-15
SA133425-LL-15
SA133425-LL-15
SA133425-R-15
SA133425-RA-15
SA133425-RC-15
SA133425-RG-15
SA133425-RL-15
SA133425-S-15
SA133425-U-15



**34 Rim Cylinders**

SA130090-LB-15	SA130090-RC-15
SA130090-LC-15	SA130090-RE-15
SA130090-LE-15	SA130090-RF-15
SA130090-LF-15	SA130090-RG-15
SA130090-LJ-15	SA130090-RJ-15
SA130090-LK-15	SA130090-RK-15
SA130090-LL-15	SA130090-RL-15
SA130090-RA-15	SA130090-S-15
SA130090-RB-15	



**#41 1 1/8" Mortise**

SA130401-LA-15
SA130401-LB-15
SA130401-LC-15
SA130401-LF-15
SA130401-LG-15
SA130401-LJ-15
SA130401-LL-15
SA130401-RA-15
SA130401-RB-15
SA130401-RC-15
SA130401-RE-15
SA130401-RF-15
SA130401-RJ-15
SA130401-RL-15
SA130401-S-15

**#42  
1 1/4" Mortise**

SA130402-LA-15
SA130402-RJ-15
SA130402-RL-15

**KITS & TOOLS**

**56 - Electric Latch Retraction Retrofit Kit**



**FEATURES:**  
Converting existing devices  
to a 56 33" - 36" doors

SAR56A-F-32D Kit F-Rail

**Key Gauge**



SA435

**Spindle Kits**

Kit number 578-2 is designed for 8100 mortise locks manufactured from 1975 through December of 1989 (neck type inside spindle). This kit includes: Pre-drilled spindle assembly, Lever grub screws (2), Nylon bushings (2), Lever spiral pin, Spindle.

Kit number 579-2 is designed for 8100 mortise locks manufactured from January 1990 - present (lever adapter type). This kit includes: Pre-drilled spindle assembly, Lever grub screws, Lever adapter, Nylon bushings (2), Lever spiral pin.

SA578-2	1 3/4"
SA579-2	1 3/4"



**PARTS**

**80 Series Parts**

SA01-0098	80 SERIES E CLIP RET RING
SA565-32D	80 SERIES METAL END CAP KIT
SA665-32D	80 SERIES FLUSH METAL END CAP
SA68-0229-32D	80 SERIES RAIL PIVOT PIN
SA68-2143-32D	80 SERIES SCREW PACK A
SA68-3906	80 SERIES SCREW PACK B
SA809	80 SERIES LEXAN PAD
SA816-1-32D	CYLINDER DOGGING KIT 80 SERIES FOR WIDE STILE F RAIL

**8500 Series Parts**

SA68-0477	8500 LIFT LEVER LHR
SA68-0478	8500 LIFT LEVER RHR
SA98-0028	LATCHBOLT SPRING 8500/8800

**8700 Series Parts**

SA68-2163	8710 LHRB CENTER CASE L/COVER
SA68-2164	8710 RHRB CENTER CASE L/COVER
SA68-2207	8715 LHRB CENTER CASE L/COVER
SA68-2208	8715 RHRB CENTER CASE L/COVER
SA68-4568	NB-8710 LHR CENTER CASE
SA68-4569	NB-8710 RHR CENTER CASE
SA97-0392-32D	NB8710 TOP LATCH COVER
SA68-4549	BOTTOM LATCH 8710 8715
SA68-4557	TOP LATCH 8710 8715
SA68-3933	NB8710 TOP LATCH
SA68-0405-32D	CENTER CASE COVER 8710/8715
SA97-0018-32D	COVER TOP AND BOTTOM 8700

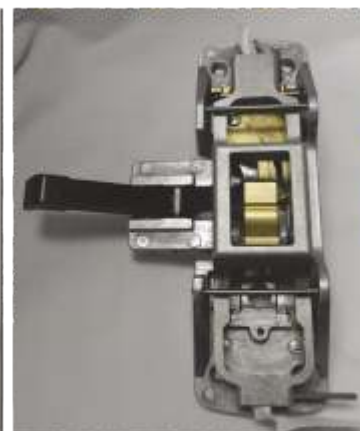

**8800 Series Parts**

SA644	SURFACE APPLIED STRIKE 8800 FOR PAIRS OF DOORS WITHOUT MULLIONS	
SA649	STANDARD STRIKE	8800 12-8800
SA68-4261	RIM CENTER CASE CHASSIS	8888/8810
SA68-0406-32D	RIM CENTER CASE CHASSIS COVER	8888/8810
SA98-0028	LATCHBOLT SPRING	8500/8800



**Miscellaneous**

SA68-2596	HEX KEY DOGGING KIT
SA730-4	700-4 SERIES SPINDLE 1-3/4" DR FOR ALL AD/MD8400 AND AD/WD/MD8600 DEVICES
SA730-7	700-8 SERIES SPINDLE 1-3/4" DR CROSS TYPE SPINDLE
SA730-8	700-8 SERIES SPINDLE 2" DR CROSS TYPE SPINDLE
SA94-0088	CYLINDER HUB FOR NARROW EXIT
SA97-0052-32D	EXIT COVER SCREW
SA97-0425	ET LEVER RETURN SPRING
SA55-M56A-F	ELR MOTOR KIT WITH SIGNAL SWITCH
SA55-R56A-F-32D	ELR RETROFIT KIT WITH MONITOR F-RAIL FOR 33-36" DOOR
SA589-EN	GLASS BEAD SHIM KIT
SAM56A-F	MOTOR ASSEMBLY KIT 36" DOOR FOR DEVICES MFG AFTER 2006
SA3520	POWER SUPPLY 24VDC 1-AMP REGULATED
SA855-1-32D	SIGNAL SWITCH



**LOCKSET DESIGNS & FUNCTIONS**

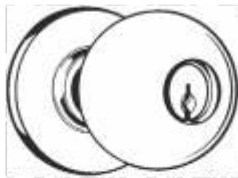

Orbit (ORB; A, D, & F Series)

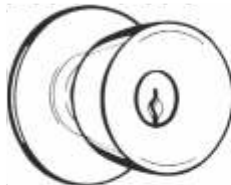

Tulip (TUL; A & D Series)

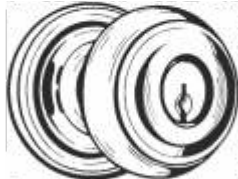

Georgian (GEO; A & F Series)

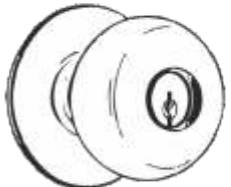

Plymouth (PLY; A, D, & F Series)

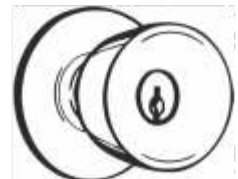

Bell (BEL; F Series)

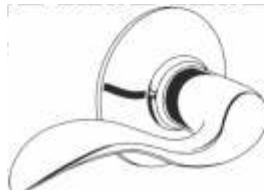

Accent (ACC; F Series)



Elan (ELA; F Series)



Flair (FLA; F Series)



Jupiter (JUP; AL Series)



Rhodes (RHO; ND Series)



Saturn (Sat; AL Series)



Sparta (SPA; ND Series)



Neptune (NEP; AL Series)



Omega (OME; ND Series)



**Exit Lock**

Blank plate outside. Inside knob always unlocked.



**Passage Latch**

Both knobs always unlocked.



**Privacy Lock**

Push button locking. Opened from outside with small screwdriver or flat narrow tool. Turning inside knob or closing door releases button.



**Entrance/Office Lock**

Push button locking. Pushing button locks outside knob until unlocked by key or turning in-side knob. Pushing and turning button locks outside knob requiring use of a key until button is manually unlocked. (Office function does not allow button to turn).



**Classroom Lock**

Outside knob locked and unlocked by key. Inside knob always unlocked.



**Storeroom Lock**

Outside knob fixed. Entrance by key only. Inside knob always unlocked.



**Institutional Lock**

Both knobs fixed. Entrance by key in either knob.



**Store Lock**

Key in either knob locks or unlocks both knobs.



**Vestibule Lock**

Opened by key from outside when outer knob is locked by key in inner knob. Inner knob always free.



**Corridor Lock**

Locked or unlocked by key from outside. Push button locking from inside. Turning inside knob or closing door release button.

**Lockset Finishes**

- 605 Bright Brass
- 609 Antique Brass
- 612 Satin Bronze
- 613 Oil Rubbed Bronze
- 619 Satin Nickel
- 626 Satin Chrome



## A SERIES KNOBS



**Features:**

- ANSI A156.2, 1996, Series 4000, Grade 2, UL Listed for 3-hour fire door
- 2 3/4" Backset latch included (see A Series parts section for options)
- Supplied less cylinder (40-100 multi-tailpiece cylinder is suggested- see cylinder section)



**PASSAGE**

- SCA10S-ORB-626
- SCA10S-PLY-605
- SCA10S-PLY-612
- SCA10S-PLY-626
- SCA10S-TUL-626



**STOREROOM**

- SCA80LD-ORB-605
- SCA80LD-ORB-612
- SCA80LD-ORB-613
- SCA80LD-ORB-626
- SCA80LD-PLY-605
- SCA80LD-PLY-626
- SCA80LD-TUL-626



**ENTRANCE**

- SCA53LD-GEO-605
- SCA53LD-GEO-609
- SCA53LD-ORB-605
- SCA53LD-ORB-612
- SCA53LD-ORB-613
- SCA53LD-ORB-626
- SCA53LD-PLY-605
- SCA53LD-PLY-612
- SCA53LD-PLY-626
- SCA53LD-TUL-605
- SCA53LD-TUL-626



**PRIVACY**

- SCA40S-ORB-613
- SCA40S-ORB-626
- SCA40S-PLY-626



**EXIT**

- SCA25D-PLY-626



**CLASSROOM**

- SCA70LD-ORB-626
- SCA70LD-PLY-626



**A SERIES / LEVERSETS**

- Inside Trim - Levon Lever Design
- Outside Trim - Plymouth Lever Design

SCA10S-LEV-626

PASSAGE

SCA40S-LEV-605

PRIVACY

## D SERIES HEAVY DUTY KNOBS



**Features:**

- ANSI A156.2, Series 4000, Grade 1
- 2 3/4" Backset latch included (see D Series parts section for options)
- Supplied less cylinder (40-100 multi-tailpiece cylinder is suggested- see cylinder section)



**ENTRANCE**

- SCD53LD-ORB-626
- SCD53LD-PLY-626



**INSTITUTION**

- SCD82CD-PLY-626



**STOREROOM**

- SCD80LD-ORB-626
- SCD80LD-PLY-626
- SCD66CD-PLY-626

Allegion creates peace of mind by pioneering safety and security.

Call or visit us today to speak with one of our experts about the Allegion products we carry and a solution that is right for you.

877-671-7011 [allegion.com/us](http://allegion.com/us)



Schlage LE

Schlage NDE  
Cylindrical applications

Schlage Control™  
Residential applications

Electronic credentials  
Cards, fobs and wristbands

## Connect and control more doors a whole lot easier than ever before

Introducing the Schlage® LE wireless lock for mortise door applications. LE wireless locks are ideal for interior openings in commercial, mixed-use and multi-family settings, where improving efficiency and reducing costs are an increasing concern. Like Schlage Control™ and NDE, LE wireless locks can be managed with ENGAGE™ web and mobile apps—now with enhanced capabilities.

Allegion offers an array of products and solutions for a multitude of applications. Visit our website to find out more at [allegionengage.com](http://allegionengage.com).

aptiQ ■ SCHLAGE

Schlage is the property of Allegion plc. All other brand names, product names or trademarks are the property of their respective owners.

**ALLEGION™**   
Authorized distributor

011530 © 2017 Allegion

**AL SERIES LEVERS**



*Features:*  
 • ANSI A156.2, 1996, Series 4000, Grade 2, UL Listed for 3-hour fire door  
 • 2 3/4" Backset latch included (see AL Series parts section for options)  
 • Supplied less cylinder (40-100 multi-tailpiece cylinder is suggested-see cylinder section)



**PASSAGE**

SCAL10S-NEP-605  
 SCAL10S-NEP-626  
 SCAL10S-SAT-605  
 SCAL10S-SAT-612  
 SCAL10S-SAT-613  
 SCAL10S-SAT-626



**CLASSROOM**

SCAL70LD-NEP-626  
 SCAL70LD-SAT-605  
 SCAL70LD-SAT-612  
 SCAL70LD-SAT-613  
 SCAL70LD-SAT-626  
 SCAL70JD-SAT-626  
 (Less FSIC)



**ENTRANCE**

SCAL53LD-JUP-626  
 SCAL53LD-NEP-605  
 SCAL53LD-NEP-626  
 SCAL53LD-SAT-605  
 SCAL53LD-SAT-609  
 SCAL53LD-SAT-612  
 SCAL53LD-SAT-613  
 SCAL53LD-SAT-626  
 SCAL53JD-SAT-626  
 (Less FSIC)



**STOREROOM**

SCAL80LD-NEP-626  
 SCAL80LD-SAT-605  
 SCAL80LD-SAT-612  
 SCAL80LD-SAT-613  
 SCAL80LD-SAT-626  
 SCAL80JD-SAT-626  
 (Less FSIC)



**EXIT**

SCAL25D-SAT-626



**PRIVACY**

SCAL40S-NEP-626  
 SCAL40S-SAT-605  
 SCAL40S-SAT-613  
 SCAL40S-SAT-626



**ENTRY/OFFICE**

SCAL50LD-SAT-626



## ND SERIES HEAVY DUTY LEVERS



- Features:**
- ANSI A156.2, Series 4000, Grade 1
  - 2 3/4" Backset latch included (see ND Series parts section for options)
  - Supplied less cylinder (40-100 multi-tailpiece cylinder is suggested-see cylinder section)
  - Door thickness: 1 1/2" — 2 1/2"



**CLASSROOM**

- SCND70LD-RHO-626
- SCND70LD-SPA-626
- SCND70JD-RHO-626



**STOREROOM**

- SCND80LD-RHO-605
- SCND80LD-RHO-613
- SCND80LD-RHO-626
- SCND80LD-SPA-626
- SCND80BD-RHO-626  
(Less SFIC)
- SCND80JD-RHO-626  
(Less FSIC)



**PASSAGE**

- SCND10S-RHO-613
- SCND10S-RHO-626
- SCND10S-SPA-626



**ENTRANCE**

- SCND53LD-RHO-605
- SCND53LD-RHO-612
- SCND53LD-RHO-613
- SCND53LD-RHO-626
- SCND53LD-SPA-626
- SCND53BD-RHO-626  
(Less SFIC)
- SCND53JD-RHO-626  
(Less FSIC)



**PRIVACY**

- SCND40S-RHO-626
- SCND40S-SPA-626



**STORE**

- SCND66CD-RHO-626



**CORRIDOR**

- SCND73LD-RHO-626
- SCND73JD-RHO-626  
(Less FSIC)



**INSTITUTION**

- SCND82CD-RHO-626



**VESTIBULE**

- SCND60CD-RHO-626



**EXIT**

- SCND25D-RHO-626

- SCND80ELLD-RHO-626 Electrically Locked 12-24 DC
- SCND80EULD-RHO-626 Electrically Unlocked 12-24 DC

**ND SERIES VANDLGARD™ LEVERS**



**Features:**

- Designed to disengage outside spindle from latch when in locked condition
- Free-wheeling lever prevents damage to internal lock components caused by excessive force
- ANSI A156.2, Series 4000, Grade 1
- 2 3/4" Backset latch included (see ND Series parts section for options)
- Supplied less cylinder (40-100 multi-tailpiece cylinder is suggested- see cylinder section)



**ENTRANCE**

SCND92LD-RHO-626



**CLASSROOM**

SCND94LD-RHO-626  
SCND95CD-RHO-626  
( Security/DBL CYL)



**STOREROOM**

SCND96LD-RHO-626  
SCND96JD-RHO-626 (Less tFSIC)

**L SERIES HEAVY DUTY MORTISE LOCK**



ANSI A156.2, Series 4000, Grade 1

**EL/EU**

SCL9092EUL-06N-626-RH



**CLASSROOM**

SCL9070L-03N-626  
SCL9070L-06N-626



**CORRIDOR**

SCL9456L-03N-626  
- W/Dbolt



**ENTRANCE**

SCL9453L03N-626  
- W/Dbolt



**OFFICE**

SCL9050L-03N-626



**PASSAGE**

SCL9010-03N-626



**STOREROOM**

SCL9080L-03N-626

**B SERIES**



**B500 Series**

*Features:*  
 • Grade 2  
 • 2 3/8" — 2 3/4" adjustable backset  
 • Accepts any Schlage cylinder for maximum installation versatility



**B560  
 Single Cylinder - Grade 2**

- SCB560P-605-C
- SCB560P-605-KA4-C
- SCB560P-605-S123
- SCB560P-605-C123
- SCB560P-609-C
- SCB560P-609-KD-C
- SCB560P-609-KA4-C
- SCB560P-609-S123
- SCB560P-609-C123

- SCB560P-612-C
- SCB560P-613-C
- SCB560P-619-C
- SCB560P-626-C
- SCB560P-626-KA4-C
- SCB560P-626-S123
- SCB560P-626-C123
- SCB560P-643E-KA4-C
- SCB560R-626-FG
- SCB563P-626-C



**B562  
 Double Cylinder  
 Grade 2**

- SCB562P-605-C
- SCB562P-609-C
- SCB562P-626-C
- SCB562P-626-KA4-C



**B571  
 Occupancy Indicator Deadbolt  
 Grade 2**

SCB571-626



**B580  
 Door Bolt - Grade 2**

- SCB580-605
- SCB580-626



**B581  
 Door Bolt with Trim - Grade 2**

SCB581-626



**B600 Series**

*Features:*  
 • Grade 1  
 • Fixed backset as listed  
 • Accepts any Schlage cylinder for maximum installation versatility



**B660  
 Single Cylinder - Grade 1**

- SCB660P-626-C123
- SCB660P-605-KA4-C
- SCB660P-626-KA4-C
- SCB660P-626-KA4-CX

- 2 3/8" Backset
- 2 3/4" Backset
- 2 3/8" Backset
- 2 3/4" Backset



**B662  
 Double Cylinder - Grade 1**

- SCB662P-605-KA4-C
- 2 3/4" Backset
- SCB662P-626-KA4-C
- 2 3/4" Backset



**B250  
 Single Cylinder - Grade 2**

- SCB250P6D-626-C
- 2 3/4" Backset



**B252  
 Double Cylinder - Grade 2**

- SCB252P6D-626-C





**F SERIES**



- Features:*
- ANSI A156.5 Grade 2
  - 5 Pin, Classic C Keyway
  - 2 3/8" — 2 3/4" Adjustable square latches

**F Series Handlesets**

- Features:*
- Grade 2, Residential
  - 5 Pin, C Keyway
  - 2 3/8" — 2 3/4" Backsets



**PRIVACY**

- SCF40-ACC-619
- SCF40-ELA-605-16-200
- SCF40-ELA-609-16-200
- SCF40-ELA-626-16-200
- SCF40-FLA-605
- SCF40-FLA-609

**KNOBS**

- SCF40-GEO-605-16-200
- SCF40-GEO-609-16-200
- SCF40-ORB-626-16-200
- SCF40-PLY-605-16-200
- SCF40-PLY-626-16-200



**STOREROOM**

**KNOBS**

- SCF80-GEO-609-16-207
- SCF80-ORB-626-16-207
- SCF80-PLY-605-16-207
- SCF80-PLY-626-16-207



**PASSAGE**

- SCF10-ACC-619
- SCF10-BEL-605-16-200
- SCF10-BEL-609-16-200
- SCF10-ELA-605
- SCF10-ELA-609-16-200
- SCF10-ELA-626-16-200
- SCF10-FLA-605
- SCF10-FLA-609

**KNOBS**

- SCF10-GEO-605-16-200
- SCF10-GEO-609-16-200
- SCF10-GEO-619
- SCF10-ORB-605-16-200
- SCF10-ORB-626-16-200
- SCF10-PLY-609
- SCF10-PLY-605-16-200
- SCF10-PLY-613-16-200
- SCF10-PLY-619
- SCF10-PLY-626-16-200
- SCF10-PLY-716



**ENTRANCE**

- SCF51A-ACC-619
- SCF51A-BEL-605
- SCF51A-BEL-609
- SCF51A-ELA-605
- SCF51A-ELA-609
- SCF51A-ELA-626
- SCF51A-FLA-605
- SCF51A-FLA-609

**KNOBS**

- SCF51A-GEO-605
- SCF51A-GEO-609
- SCF51A-GEO-619
- SCF51A-ORB-605
- SCF51A-ORB-609
- SCF51A-ORB-626
- SCF51A-PLY-605
- SCF51A-PLY-626



**Plymouth**

SCF60-PLY-605

**BE & FE SERIES**

**Residential Keypad Locks**

*Features:*

- ANSII/BHMA, Grade 2
- Vandal resistant clutching lever and deadbolt turn.
- 2 5/8" — 2 3/4" adjustable backset
- 5 Pin, Classic C Keyway

- Silicone rubber, wear-resistant buttons with LED backlight
- 9V alkaline battery included
- 19 user code capacity
- No programming required; preset with two user codes - ready to use right out of the box

**BE SERIES**

**BE365 CAMELOT**



- SCBE365-CAM-505
- SCBE365-CAM-609
- SCBE365-CAM-619
- SCBE365-CAM-626
- SCBE365-CAM-716

**BE365 PLYMOUTH**



- SCBE365-PLY-505
- SCBE365-PLY-609
- SCBE365-PLY-619
- SCBE365-PLY-626
- SCBE365-PLY-716

**BE375 CAMELOT**



- SCBE375-CAM-605
- SCBE375-CAM-619
- SCBE375-CAM-626
- SCBE375-CAM-716

**FE SERIES**

**FE575 CAMELOT**



**FE575 PLYMOUTH**



- SCFE575-CAM-505-ACC
- SCFE575-CAM-609-ACC
- SCFE575-CAM-619-ACC
- SCFE575-CAM-626-ACC
- SCFE575-CAM-716-ACC
- SCFE575-PLY-505-FLA
- SCFE575-PLY-609-FLA
- SCFE575-PLY-619-FLA
- SCFE575-PLY-626-FLA
- SCFE575-PLY-716-FLA

**FE595 SERIES**

**Keypad Lever with Flex-Lock Feature**

*Switch from automatic relocking to unlocked as needed*



- SCFE595-CAM-505-ACC
- SCFE595-CAM-609-ACC
- SCFE595-CAM-619-ACC
- SCFE595-CAM-626-ACC
- SCFE595-CAM-716-ACC
- SCE595-PLY-505-FLA
- SCFE595-PLY-609-FLA
- SCFE595-PLY-619-FLA
- SCFE595-PLY-626-FLA
- SCFE595-PLY-716-FLA

**PARTS — A / AL SERIES**

**REPLACEMENT KNOBS**

- SC01-018-PLY-626 Outside
- SC01-008-LEV-626 Inside

**DEADLATCHES**



- SC11-085-605 Mort: 2 3/8"
- SC11-085-612 Mort: 2 3/8"
- SC11-085-626 Mort: 2 3/8"
- SC11-091-626 Mort: 2 3/4"
- SC11-096-605 Mort: 2 3/4"
- SC11-096-612 Mort: 2 3/4"
- SC11-096-626 Mort: 2 3/4"
- SC11-103-626 Mort: 2 3/4"
- SC11-104-606 Drive In: 2 3/8"
- SC11-105-606 Drive In: 2 3/4"
- SC11-105-626 Drive In: 2 3/4"



**SPRINGLATCHES**



- SC11-068-605 Mort: 2 3/8"
- SC11-068-612 Mort: 2 3/8"
- SC11-068-626 Mort: 2 3/8"
- SC11-116-605 Mort: 2 3/4"
- SC11-116-626 Mort: 2 3/4"
- SC11-110-606 Drive In: 2 3/8"
- SC11-113-606 Drive In: 2 3/4"



**EXTENSION LINKS**



- SC41-005 For 5" backset use with 2 3/8" latch

**LEVER PARTS**



- SCA700-015 Lever Insert, AL Series 2 Tab



- SCA700-044 Plastic Adapter (Lever Insert)



- SCA710-004 Spindle & Catch, Inside



- SC51-037-626 Plunger Unit, AL53

**KNOB PARTS**



- SCA501-615 Spindle Wedge, A80, A85



- SCA508-640 A-Line Spacer



- SC01-060-PLY-626 Plunger Unit, A53



**PARTS — B SERIES**

**B500**

**Mounting Screws**

- SCB600-078 For B562 (1 3/8" - 2 3/4" Door)
- SCB600-101 For B560 (1 3/8" - 2 3/4" Door)

**Thumbturn Screws for B560**

- SCB600-066-632 Satin Brass
- SCB600-066-652 Satin Chrome

**B560 Deadbolts**

- SC12-288-605 Sq corner adjust
- SC12-288-626 Sq corner adjust
- SC12-290-626 Drive-In adjust
- SC12-287-605 Triple Option
- SC12-287-626 Triple Option

**B250**

**Mounting Screws**

- SCB520-086-626 For B250 (2 1/4")

**B600**

**Screw Packs - Standard Screws**

- SCB610-051 2" - 2 1/2" B660

**B660 Deadbolts**

- SC12-630-605 Mort: 2 3/8"
- SC12-630-626 Mort: 2 3/8"
- SC12-631-605 Mort: 2 3/4"
- SC12-631-626 Mort: 2 3/4"
- SC12-633-626 Mort: 5"
- SC12-640-626 Drive In: 2 3/8"
- SC12-641-626 Drive In: 2 3/4"

**Latches**

- SC12-100-605 B250 Mort: 2 3/8"
- SC12-100-626 B250 Mort: 2 3/8"
- SC12-103-605 B250 Mort: 2 3/4"
- SC12-103-626 B250 Mort: 2 3/4"



**B250 & B251**

**Rose & Turn**



- SCB202-672-626 For B250



**Blank Rose For B251**

- SCB502-815-626 For B25-1



**Adapter Ring - 2 1/8" HOLE**

- SC38-016-605
- SC38-016-626

**PARTS — F SERIES**

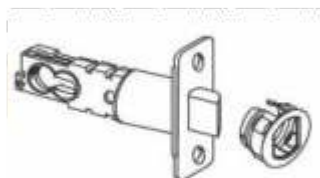

**Springlatch**

- SC16-200-605 Springlatch Mort. Adj.
- SC16-200-626 Springlatch Mort. Adj.
- SC16-080-626 Springlatch Dual Option (RC-D/I)

**Deadlatch**

- SC16-126-605 Deadlatch Mort. 5"
- SC16-207-605 Deadlatch Mort. Adj.
- SC16-207-626 Deadlatch Mort. Adj.
- SC16-086-626 Deadlatch Dual Option (RC-D/I)

**PARTS — L, D, & ND SERIES**





**PARTS — L SERIES**

**LOCK CASE (CHASSIS ONLY)**



- SCL9010B Chassis Only
- SCL9040B Chassis Only
- SCL9070LB Chassis Only
- SCL9080LB Chassis Only
- SCL9453LB Chassis Only
- SCL9456LB Chassis Only

**ARMOR FRONT FOR L9000 SERIES**

-  SC09-662-626 For L9010, L9040
-  SC09-663-612 For L9050, L9060,  
SC09-663-613 L9070, L9080, L9082  
SC09-663-625  
SC09-663-626
-  SC09-664-626 For L9456, L9465,  
L9466, L9473
-  SC09-666-626 For L9453, L9485,  
L9486

**PARTS & CAMS**

- SCL283-040 Spring Cage, L Lever
- SCL283-060 Spindle & Spring, L Lock
- SC09-509-626 Thumbturn for "L" Rose Trim
- SC10-072-626 Box Strike Standard L9000  
1 1/4" X 4 7/8" 1 3/8" LIP
- SCL583-058 L Series Simultaneous  
Retractor L9040
- SC39-042 Plastic L-Lock Case Cover

**PARTS — D SERIES**

**LATCHES**

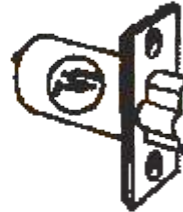

- SC14-028-626 Deadlatch Mort: 3 3/4"
- SC14-047-626 Deadlatch Mort: 2 3/4"

**REPLACEMENT PARTS**

- SCC604-191 Slide Catch Spring

**EXTENSION LINKS**



- SC43-005 For 5" backset  
use with 2 3/4" latch

**PARTS — ND SERIES**

**KEYCAM ASSEMBLY**

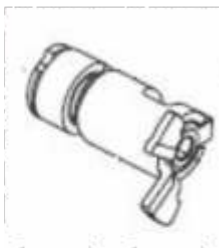

- SCN123-007 For ND50, ND 53, ND 60
- SCN123-008 For ND 80, ND82, ND12,  
ND 25X80INSIDE
- SCN123-010 For ND70, ND72, ND73,  
ND25X70OUTSIDE
- SCN123-011 For ND91, ND92, ND93
- SCN123-012 For ND94
- SCN123-045 For ND40, ND44

**LATCHES**

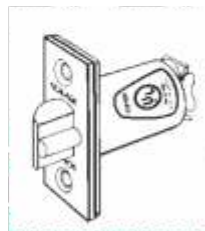

- SC13-247-626 Deadlatch 2 3/4" ND
- SC13-248-626 Springlatch 2 3/4" ND

**STRIKE PLATES**



**1 1/8" x 2 3/4" x 3/32"**  
 SC10-001-613  
 SC10-001-626



**Thimble, Drive-In**  
 1 3/16" Diameter  
 1" Barrel, 1 1/4" Depth  
 SC10-064-494



**1 1/4" x 4 7/8" x 3/32"**  
 SC10-025-605  
 SC10-025-613



**Latch Front Adapter**  
 Plastic, white  
 SCA501-878



**1 1/8" x 2 1/4"**  
 SC10-027-626

**TOOLS, ETC.**



**Keying Kit**

**Kit Includes:**  
 Bottom Pins #0 thru #9  
 Top Pins #3  
 Cylinder Springs  
 Cylinder Cap Pins  
 Cylinder Cap Pin Springs  
 Plug Follower MS40-051  
 Key Gauge 40-104  
 SC40-134



**Key Gauge**  
 SC40-104



**Spanner Wrench**  
 SC021415



**Lever Boring Jig**  
 SCM204-198



**Adjustment Tool  
 for IC Cylinders**  
 SCM504-413



**Padlock Less Cylinder**  
 SCKS43F3200  
 — LFC

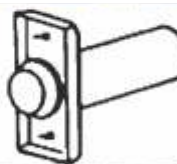

**Latch Marking Chisel**  
 SC40-031 2 1/4" x 1"  
 SC40-032 2 1/4" x 1 1/8"



**MORTISE CYLINDERS**

**Classic Keyway — 1 1/8"**

**Std Cam • Compression Ring & Spring**

- SC20-001-C-626-1-1/8"
- SC20-001-C-626-1-1/4"
- SC20-001-E-626-1-1/8"
- SC20-001-F-626-1-1/8"
- SC 20-001-FG-626-1-1/8"



**Std Cam • Compression Ring & Spring**

- SC20-001-613-118-C123
- SC20-001-613-118-CT45<sup>1 1/8"</sup>
- SC20-001-626-118-C123
- SC20-001-626-118-C145



**Level One — 1 1/8"**

**Std Cam • Compression Ring & Spring**

- SC20-700-1001CP-613
- SC20-700-1001CP-626

**A/R Cam • 3/8" Blocking Ring**

- SC20-706-1001CP-613
- SC20-706-1001CP-626

**A/R Cam Only**

- SC20-706-1178CP-613LKB
- SC20-706-1178CP-626LKB
- SC20-706-1183EP-626LKB
- SC20-706-C123-626

Everest/Primus

**A/R Cam • 3/8" Blocking Ring**

- SC20-013-C-613-1-1/8"
- SC20-013-C-626-1-1/8"
- SC20-013-E-613-1-1/8"
- SC20-013-E-626-1-1/8"

**A/R Cam • 3/8" Blocking Ring**

- SC20-013-613-118-C123
- SC20-013-613-118-C145
- SC20-013-626-118-C123
- SC20-013-626-118-C145
- SC20-013-626-118-S123

**Everest 29**

- SC20-001-626-118-S123
- SC20-013-613-118-S123
- SC20-729-S123-626

**Level 1+**

- SC20-700-1178CP-613LKB
- SC20-700-1178CP-626LKB
- SC20-700-1376-613-LKB
- SC20-700-1376-626-LKB
- SC20-700-1378-613-LKB
- SC20-700-1378-626-LKB
- SC20-700-1381-613-LKB
- SC20-700-1381-626-LKB
- SC20-706-1376-613-LKB
- SC20-706-1376-626-LKB
- SC20-706-1378-613-LKB
- SC20-706-1378-626-LKB
- SC20-706-1381-613-LKB
- SC20-706-1381-626-LKB



Std Cam  
AR Cam  
B100 Cyl Only

- 1+ CP MORT CYL 118 STD CAM
- 1+ CP MORT CYL 118 STD CAM
- 1+ FGP MORT CYL 118 STD CAM
- 1+ FGP MORT CYL 118 STD CAM
- 1+ EP MORT CYL 118 STD CAM
- 1+ EP MORT CYL 118 STD CAM
- 1+ CP MORT CYL 118 ADR CAM
- 1+ CP MORT CYL 118 ADR CAM
- 1+ FGP MORT CYL 118 ADR CAM
- 1+ FGP MORT CYL 118 ADR CAM
- 1+ EP MORT CYL 118 ADR CAM
- 1+ EP MORT CYL 118 ADR CAM

**RIM CYLINDERS**

**Classic Keyway (with mounting plate & screws)**

**C Keyway**

- SC20-022-C-613
- SC20-022-C-626



**C123 Keyway**

- SC20-022-613-C123
- SC20-022-626-C123

**E Keyway**

- SC20-022-E-626

**F Keyway**

- SC20-022-F-626

**C145 Keyway**

- SC20-022-613-C145
- SC20-022-626-C145

**S123 Keyway**

- SC20-022-626-S123



*(continued next page)*

### RIM CYLINDERS — continued



(with collar, mounting screws, & backplate)

**Level One**

SC20-710-1001CP-613  
 SC20-729-1001CP-606  
 SC20-710-1001CP-626

**Level 1+**

SC20-729-1178CP-626LKB  
 SC20-710-1178CP-613LKB  
 SC20-710-1178CP-626LKB  
 SC20-706-1376-613-LKB  
 SC20-706-1376-626-LKB

PRIMUS 1+ CYL/B SERIES  
 PRIMUS 1+ RIM CYL  
 PRIMUS 1+ RIM CYL  
 1+ CP MORT CYL 118 ADR CAM  
 1+ CP MORT CYL 118 ADR CAM

**Level 1+ (Continued)**

SC20-706-1378-613-LKB  
 SC20-706-1378-626-LKB  
 SC20-706-1381-613-LKB  
 SC20-706-1381-626-LKB  
 SC40-700-1376-606-LKB  
 SC40-700-1378-606-LKB  
 SC40-700-1381-606-LKB  
 SC40-700-1381-626-LKB  
 SC40-700-626-1376-LKB  
 SC40-700-626-1378-LKB

1+ FGP MORT CYL 118 ADR CAM  
 1+ FGP MORT CYL 118 ADR CAM  
 1+ EP MORT CYL 118 ADR CAM  
 1+ EP MORT CYL 118 ADR CAM  
 1+ CP MULTI-TP KIK/KIL CYL  
 1+ FGP MULTI-TP KIK/KIL CYL  
 1+ EP MULTI-TP KIK/KIL CYL  
 1+ EP MULTI-TP KIK/KIL CYL  
 1+ CP MULTI-TP KIK/KIL CYL  
 1+ FGP MULTI-TP KIK/KIL CYL

**Level 7**

SC20-710-C123-613 EV/PMS  
 SC20-710-C123-626 EV/PMS

### KEY-IN-KNOB/LEVER CYLINDER

**C Keyway – By series**

**A/H Knobs**

SC21-002-C-KD-626

**ND Levers**

SC23-065-C-KD-626  
 SC23-065-C123-626



**AL Levers**

SC21-020-C-KD-606  
 SC21-020-C-KD-626

**F Series 5-Pin (429 to match 626)**

SC29-016-C-KD-626 Bel/Geo/Ply  
 SC29-018-C-KD-626 ACC/FLA

**Classic Multi-Tailpiece**

**C**

SC40-100-606-C  
 SC40-100-626-C  
 SC40-700-C123-606

EV-PRM KIK/L  
 MULTI TAILPC

**CE**

SC40-100-606-CE  
 SC40-100-626-CE

**E**

SC40-100-606-E  
 SC40-100-626-E

**EF**

SC40-100-606-EF  
 SC40-100-626-EF

**F**

SC40-100-606-F  
 SC40-100-626-F

**G**

SC40-100-626-G

**FG**

SC40-100-606-FG  
 SC40-100-626-FG



**Multi-Tailpiece**

**C123**

SC40-100-606-C123  
 SC40-100-626-C123

**C135**

SC40-100-626-C135

**C145**

SC40-100-626-C145

**Everest 29**

SC40-100-606-S123  
 SC40-100-626-S123

SC40-100-606-C145

SC40-100-626-S145



**Level 1**

SC40-700-1001CP-626  
 SC40-700-1001CP-606

**Level 1+**

SC40-700-1178CP-606  
 SC40-700-1178CP-626

**Level 7**

SC40-700-C123-606  
 SC40-700-C123-626

**DEADBOLT CYLINDERS**

**SCHLAGE  
PRIMUS**

**B100, 250, H SERIES**

**Level 1**

SC20-729-1001CP-606  
SCZV20-729-1001CP-626

**Level 7**

SC20-729-S123-606  
SC20-729-C123-626

**Level 1+**

SC20-729-1376-606-LKB	1+ CP B-SERIES CYL
SC20-729-1376-626-LKB	1+ CP B-SERIES CYL
SC20-729-1378-606-LKB	1+ FGP B-SERIES CYL
SC20-729-1378-626-LKB	1+ FGP B-SERIES CYL
SC20-729-1381-606-LKB	1+ EP B-SERIES CYL
SC20-729-1381-626-LKB	1+ EP B-SERIES CYL

**FSIC HARDWARE**

**FSIC Complete Cylinders**



SC20-057-FG-626 Rim FSIC FG 1-Bitted Convertible Tailpiece  
SC26-098-FG-626 Mortise FSIC w/ AR Cam

**FSIC Housings (less core)**



<b>Mortise</b>	<b>Rim</b>
SC20-059-613 Std Cam	SC20-079-613
SC20-059-626 Std Cam	SC20-079-626
SC20-060-613 A/R Cam	
SC20-060-626 A/R Cam	

**FULL-SIZE INTERCHANGEABLE CORES (FSIC)**



**Classic Keyways**

SC23-030-C-606  
SC23-030-C-626  
SC23-030-E-606  
SC23-030-E-626  
SC23-030-F-626  
SC23-030-FG-626

**EVEREST Keyways**

SC23-030-606-C123  
SC23-030-606-C145  
SC23-030-626-C123  
SC23-030-626-C145  
SC23-030-626-S123  
SC23-030-626-S145

**PRIMUS Keyways**

SC20-740-1001CP-606	Level One
SC20-740-1001CP-626	Level One
SC20-740-1178CP-626	Level 1+
SC20-740-1376-626-LKB	1+ CP FSIC CORE
SC20-740-1378-626-LKB	1+ FGP FSIC CORE
SC20-740-1381-626-LKB	1+ EP FSIC CORE

**MODULAR CYLINDER PARTS**

**Modular Service Kit —  
Housing, Plug Extention, Screws**

SC09-992 1 1/8" Mortise  
SC09-993 1 1/4" Mortise  
SC09-994 1 3/8" Mortise  
SC09-995 1 1/2" Mortise



SC09-996  
SC09-997  
SC09-998

1 5/8" Mortise  
1 3/4" Mortise  
Rim Cylinder w/ tailpiece,  
driver, mounting plate & screws



**Modular Front Housing**

SCK110-480-605 Bright Brass  
SCK110-480-606 Satin Brass  
SCK110-480-609 Antique Brass  
SCK110-480-612 Satin Bronze  
SCK110-480-613 Oil Rubbed Bronze

SCK110-480-619 Satin Nickel  
SCK110-480-625 Bright Chrome  
SCK110-480-626 Satin Chrome  
SCK110-480-316 Dull Bronze 643E



*(continued next page)*



## MODULAR CYLINDER PARTS — continued

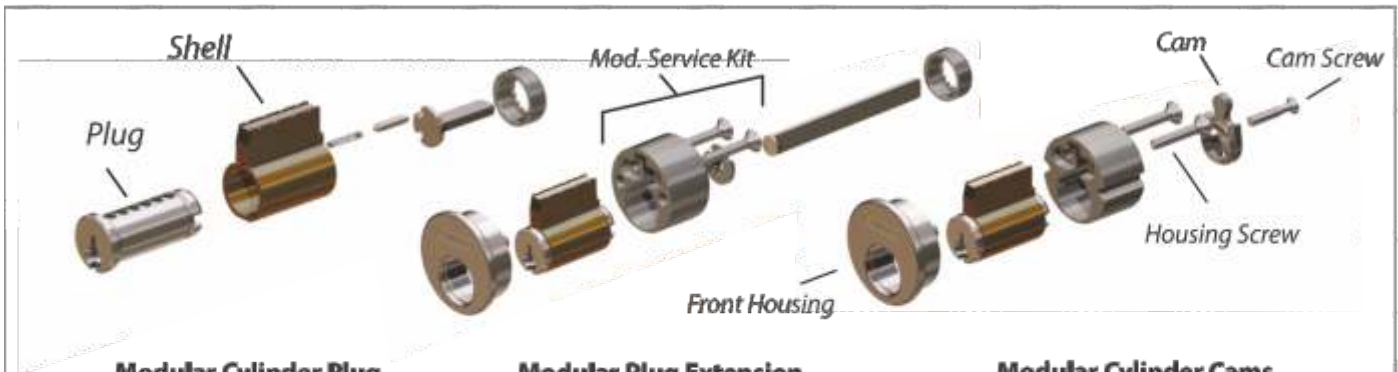

### Modular Cylinder Plug Classic

- SC33-137-606-E
- SC33-137-626-C
- SC33-137-626-CE
- SC33-137-626-E
- SC33-137-626-EF
- SC33-137-626-F
- SC33-137-626-FG



- SC33-138-626-C123
- SC33-138-626-C145

### Modular Cylinder Shell

- SCA508-653      Classic/Everest

### Modular Plug Extension

- SCB590-298      For 1 3/8" 1 1/2"
- SCB590-299      For 1 3/8" 1 3/4"

### Modular Cam Screw

- SCB520-690      For 1 3/8" & 1 1/4" cyl.
- SCB520-691      For 1 3/8" & 1 1/2" cyl.
- SCB520-692      For 1 3/8" & 1 3/4" cyl.

### Modular Housing Screw

- SCB520-693

### Tail Piece & Driver

- SCC604-243      AD Series
- SCN523-022      ND Series

### Tail Piece & Retainer

- SCB610-084      B660, 1 3/8" - 2 1/2"
- SCB610-085      Primus Bar, 1 3/8" - 2"
- SCN523-022      B662, 1 3/8" - 2"

### Modular Cylinder Cams

*For 1 1/4", 1 1/2", 1 3/4" Cylinders*

- SCB520-733      Corbin Russwin
- SCB520-737      Yale/Sarg/Arrow
- SCL583-447      Adams Rite
- SCL583-475      "L"
- SCL583-477      Straight

*For 1 3/8", 1 3/4", 1 7/8" Cylinders*

- SCB520-732      Corbin Russwin
- SCB520-736      Yale/Sarg/Arrow
- SCL583-446      Adams Rite
- SCL583-474      "L"
- SCL583-476      Straight
- SCB520-734      Mod Cam Corbin Russwin A65

## MORTISE CYLINDER PARTS

### Mortise Cams

- SCL583-198      Corb-Russ, Cloverleaf

### Classic

- SCL583-254      Cloverleaf



### Cylinder Rings

- SC36-082-037-626
- SC36-082-018-626      Blocking Ring

### Screws

- SCB502-942      Cam Screw Everest/Primus

## RIM CYLINDER PARTS

- SCB502-310-604      Driver
- SCB502-899          Tailpiece

- SCB502-949          Driver, B-Series Primus (Lazy)

**KNOB/LEVER/DEADBOLT CYLINDER PARTS**

SCC503-115 Cap Pin Spring  
 SCC503-116 Cap Pin  
 SCC503-118 Cap

**Tailpiece & Driver**

SCA700-031 Tailpiece – A, AL, H  
 (except orbit) / Driver  
 SCA508-606 Tailpiece – A, H / Driver  
 SCA508-614 Tailpiece – Orbit / Driver  
 SCC603-524 Tailpiece – AD /  
 Conventional, Classic / Driver  
 SCN523-023 Tailpiece – ND /  
 Conventional, Classic

**F-Series Parts**

SCF506-451 Top T-Pin 100/Pkg  
 SCF506-452 Removable Cap 25/Pkg  
 SCF506-453 T-Pin Top Spring 100/Pkg  
 SC33-005-C-626 PLUG CYLINDER KNOB  
 SC33-005-F-626 PLUG CYLINDER KNOB  
 SC33-085-306 WE F-KNOB PLUG 605  
 SC33-085-381 WE F-KNOB PLUG 626  
 SC33-086-381 WE F-KNOB PLUG (ORB) 626

**Tailpieces**

**B100, B250, H, 5200**

SCB202-269 DBL 3/4"  
 SCB202-558 2" Single  
 SCB202-369 DBL 1 3/4" - 3"  
 SCB202-370 DBL 1 3/8" - 1 3/4"  
 SCB202-557 Single 1 7/8"  
 SCB220-032 DBL 1 1/16"  
 SCE205-204 3" Breakoff  
 SCB220-036 DBL 1 3/8"

**B560**

SCB520-651 1 3/8" - 1 3/4"  
 SCB520-652 1 3/4" - 2 1/4"



**B562**

SCB600-045 1 3/8" - 1 3/4"  
 SCB600-046 1 3/8" - 2 1/4"  
 SCB600-086 1 3/4" - 2 1/4" (B/Priod)



**B600 (Tailpiece & Retainer)**

SCB610-044 B660, Classic  
 SCB610-045 B662, Classic  
 SCB610-046 B662, 2" - 2 1/2"  
 SCB520-375 Driver - B - Series

**EVEREST™ Cylinder Parts**

SC34-007 Check Pin  
 SCC603-951 Finger Pin Spring  
 SC40-225 Everest 29 Duplicating Shim



**Cylinder Parts**

**Mortise Cams**

SCB520-309 Corb-Russ  
 SCB520-329 Yale/Saig  
 SCB502-944 AR  
 SCB502-948 STD, ea  
 SCL583-153 L-Series, ea

**Rim Driver – Lazy**

SCB502-949 B-Series

**Finger Pins & Springs**

SC34-001 #1 Pin  
 SC34-002 #2 Pin  
 SC34-003 #3 Pin  
 SC34-004 #4 Pin  
 SC34-005 #5 Pin  
 SC34-006 #6 Pin  
 SCC603-950 Side Bar  
 SCC603-951 Finger Pin Spring  
 SCC603-952 Side Bar Spring

### SFIC/FSIC PARTS

**Misc Parts**

SCCL7788-PA-D FSIC Actuator  
 SCN523-127 FSIC Driver – ND  
 SC01-126 FSIC Driver & Retainer  
 SCA700-052 FSIC Core Drive/Universal  
 SCD500-000 Spacer ND/AL  
 SCC604-381 SFIC Driver

SCN523-091 SFIC Driver – ND  
 SCK510-680 FSIC Cam: L9060 (Outside)  
 SCK510-711 FSIC Cam: A/R MS  
 SCK510-730 FSIC Cam: Straight  
 SCL583-255 FSIC Cam: L Series  
 (except L9060 Outside)  
 SCL583-200 Cam Screw – FSIC Mortise  
 SCL603-967 FSIC Control Bottom Pin

**B600 Tailpiece for:**

SCB202-557 I/C (B660BD)  
 SCB220-001 Tailpiece & Driver  
 FSIC RIm  
 SCB220-032 I/C (B661BD)

### CLASSIC KEY BLANKS

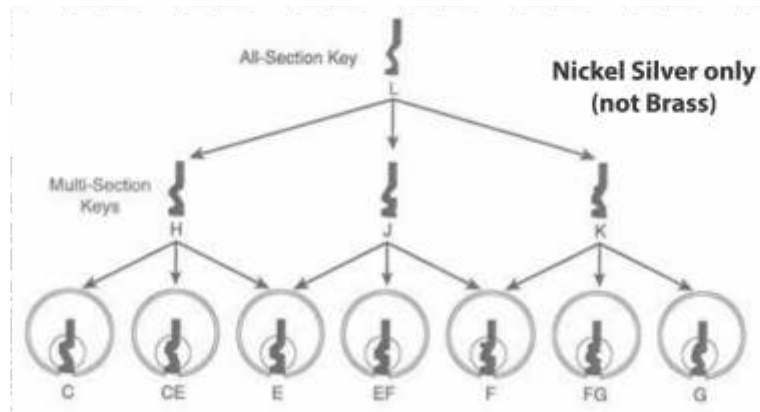

SC35-102-E Key Blank Emergency

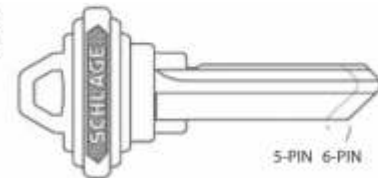

**5-Pin Classic**

SC35-100-C  
 SC35-100-CE  
 SC35-100-E  
 SC35-100-F

**6-Pin Classic**

SC35-101-C  
 SC35-101-CE  
 SC35-101-E  
 SC35-101-EF  
 SC35-101-F  
 SC35-101-FG  
 SC35-101-G  
 SC35-101-H  
 SC35-101-J  
 SC35-101-K

**DND – Do Not Duplicate**

SC35-100-C-DND  
 SC35-100-E-DND  
 SC35-101-C-DND 6-Pin  
 SC35-101-E-DND 6-Pin  
 SC35-101-FG-DND 6-Pin  
 SC35-140-C-XQ06-878 5-Pin



**FSIC Control Blanks**

SC35-056-C  
 SC35-056-E  
 SC35-056-F  
 SC35-056-FG

### EVEREST KEY BLANKS



**DND – Do Not Duplicate**

SC35-009-C000 SC35-009-C124  
 SC35-009-C100 SC35-009-C135  
 SC35-009-C120 SC35-009-C145  
 SC35-009-C123 SC35-009-C150

SC35-002-C123  
 SC35-015-C135

**FSIC Control Blanks**

SC35-003-C123  
 SC35-003-C135  
 SC35-003-C145

### EVEREST 29 KEY BLANKS



SC35-270-S123  
 SC35-270-S145  
 SC35-268-S123  
 SC35-269-S123  
 SC35-269-S145  
 SC35-157-1001-CP  
 SC35-157-1003-FGP  
 SC35-157-1006-EP

DND  
 FSIC Control Blank  
 FSIC Change Key Blank  
 PRIMUS LEVEL 1 KEY BLANK  
 PRIMUS LEVEL 1 KEY BLANK  
 PRIMUS LEVEL 1 KEY BLANK



**BE469**

**Touchscreen Deadbolt**



**Features:**

- *NSI Grade 1 Highest Residential Security*
- *Anti-pick shield protects against lock tampering*
- *Durable Resistive Touchscreen with matte finish to protect against finger prints and smudges*
- *Strong motorized bolt automatically locks and unlocks when a user code is entered*
- *Warning beep alerts you when the deadbolt is not fully extended*
- *Build-in Alarm Technology senses movement of the door and alerts homeowners with an audible alert*
- *Select between three alerts- activity, tamper or forced entry alert- and customized to meet fit your security needs*
- *With Nexia™ Home Intelligence, lock or unlock your door from anywhere with your cell phone*
- *With Nexia™ Home Intelligence, schedule lock codes to be active only on certain days at specific times*
- *Holds up to 30 (4 to 8 digit) user codes*
- *Preset with 2 user codes*

- SCBE469NX-CAM-605
- SCBE469NX-CAM-619
- SCBE469NX-CAM-716
- SCBE469NX-CEN-619
- SCBE469NX-CEN-625
- SCBE469NX-CEN-626
- SCBE469NX-CEN-716

- BRIGHT BRASS
- SATIN NICKEL
- AGED BRONZE
- SATIN NICKEL
- BRIGHT CHROME
- SATIN CHROME
- AGED BRONZE

**AD SERIES**

**AD-200**

**Locks Less Readers**



**Features:**

- *Field reversible handing*
- *4 AA battery kit*
- *Audit trail reports allow tracking of usage and events*
- *Update users and access rights using the keypad or handheld device*
- *The ability to upgrade to a networked solution without removing the lock from the door*

SCAD-200-CY-70-LLL Sparta

**Keypads**



**SCKP-626**



IR MT-GRY

IR MTK-GRY

**SPECIAL ORDER ONLY**

**CO SERIES**

**CO-100**



**Cylindrical**

SCCO100CY70KP-626-BD  
 SCCO100CY70KP-626-JD  
 SCCO100CY70KP-RHO-626  
 SCCO100CY70KP-RHO-BD  
 SCCO100CY70KP-RHO-JDLH  
 SCCO100CY70KP-RHO-JDRH  
 SCCO100CY70KP-SPA-626

**Mortise**

SCCO100MS70KP-SPA-626  
 SCCO100MS70KP-RHO-626-JD-RH  
 SCCO100MS70KP-SPA-626-BD

*Features:*

- Manually Programmable
- Up to 500 unique 3-6 digit PIN codes stored on the lock
- ANSI/BHMA Grade 1 certified and UL 294 listed\*
- Normal, toggle, pass through, and freeze credential attributes available

**Exit Trim with FSIC Prep**

SCCO100993R-RHO-JD-LHR  
 SCCO100993R-RHO-JD-RHR

**CO Series Parts**

SC46928552 Exterior Spring Cage for CO 100

**CO-200**



**Cylindrical**

SCCO200CY70KP-SPA-626

**Exit Trim**

SCCO200993RPK-SPA-626

**CO Series Parts**

SC44487247 Keypad Membrane CO Series

*Features:*

- Computer programmable with audit trail
- Up to 2000 users & up to 2000 audits
- Up to 32 holidays & 16 time zones
- ANSI/BHMA Grade 1 certified and UL 294 listed
- The ability to add and delete users at the lock
- Available in cylindrical, mortise, mortise deadbolt, and exit trim

**NDE SERIES**



SCNDE80BD-RHO-626  
 SCNDE80JD-RHO-626  
 SCNDE80LD-RHO-626  
 SCNDE80LD-SPA-626

*Lever handing is field reversible*

*Manage lock configuration and users from anywhere using the ENGAGE web and mobile apps*  
*Up to 2 years of battery life with 4 AA batteries*  
 ANSI/BHMA Grade 1

**PROGRAMMING HHD**

**Programming for CO-100 & CO-200**

- Features:
- 3.5 in LCD display
  - Touch Screen/Keypad Backlit
  - OS: Windows Mobile 5.0
  - Battery: Rechargeable



SCHHD-KIT-USB  
SCHH-SERIAL

Handheld Device for USB Locks Cable

**POWER SUPPLY**

**PS900 Series Power Supply**



- Features:
- Certified to meet UL294
  - 2A @ 12/24 VDC output, field selectable with jumper
  - Class 2 Rated power limited output, universal 120 -240 VAC input
  - Low voltage DC, regulated and filtered
  - Single polarized connector for distribution board
  - Fused primary input
  - AC input and DC output monitoring circuit w/ LED indicators
  - Cover mounted AC input indication
  - NEMA 1 enclosure, hinged cover w/ lock down screws, high voltage protective cover

**Power Supply**

SCPS902 2 AMP  
SCPS904 4 AMP

**Battery Backup**

SC900-BB Battery Backup PS900  
SC900-BBK Battery Backup PS900 Includes 2-7A/HR Batt  
SC900-FA Fire Alarm Relay (EIR)

**M400 MAGNET SERIES**



- Features:
- Bayonet mount makes installation simpler by not requiring magnet to be held overhead while mounting screws are installed
  - Armature mount allows armature to pivot compensating for opening imperfections
  - UL1034 and BHMA Grade 1\* certified

**M420** — 500lb hold force  
SCM420 Magnet Single

**M450** — 1000lb hold force  
SCM450 Magnet Single  
SCTJ450 Top Jamb Kit Single

**M490** — 1500lb hold force  
SCM490 Magnet Single  
SCM490DE Delayed Egress  
SCM490G Gate Lock Swing/Slide  
SCM492 Magnet Double  
SCM4904F M490 1/2" Filler Plate



## KEYSWITCH & PUSHBUTTONS



### KEYSWITCH

#### Maintained

SC653-04 Maintained Single Direction  
 SC653-04-NS Maintained Narrow

#### Momentary

SC653-05 Momentary Single Direction  
 SC653-1515 Momentary Bi-Direction  
 SCP653059 650 SWITCH & LEAD ASY

#### 650 Series Parts

SCP653059 Switch & Lead Assembly



### PUSHBUTTON

SC621RD 1 1/4" Red MOM 2 3/4" x 4 1/2" SS Plate  
 SC631AL EXTREME DUTY PUSHBUTTON

## MISCELANEOUS

### Door Switch



SC679-05HM WoodDoor/Frame  
 Concealed SPDT

### 692 Series Smart Bar



SC692-36-628 36" 628 RD RHR

## SOFTWARE & CREDENTIALS

### Software

SCSXPR-SFT-1 Express O\$ine Software  
 SCP101203 CIP w/IButton Reader

### Credentials

SCSXF7410SCH Prox Card  
 SCIBF Touch Entry FOB

## ELECTROMAGNETIC LOCKS

### M32 600lb Holding Force Magnalock®

Recommended for applications where physical assault on the door is not expected, like access controlled interior rooms and secure areas within buildings.

**Features:**

- Instant release circuit - no residual magnetism
- Surface mounts
- Fully sealed electronics - tamper proof and weatherproof
- Mounted using steel machine screws into blind finishing nuts
- Architectural brushed stainless steel finish (US32D/630)
- All ferrous metal surfaces.
- Hardware accessories available to configure any opening type include mounting brackets.
- Ten feet [3.05m] of jacketed, stranded conductor
- Also available in Face Mount models
- 600 lb. holding force with auto dual voltage

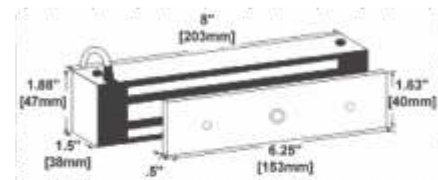
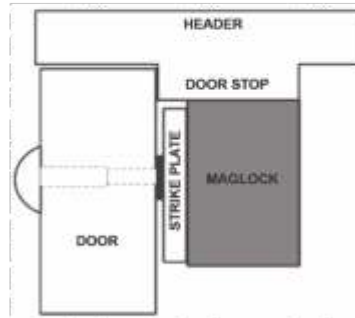

The M32 requires 2.25 inches of flat mounting space

**Specification Data**

- Holding Force: 600 lbs. [272 Kg.]
- Current Draw and Voltage: 300mA at 12VDC; 150mA at 24VDC
- Operating Temperature: -40 to +140F [-40 to +60C]
- SEM32 Minimag 12/24VDC
- SEM32F Minimag 12/24VDC Face Mount

### M62 1200lb Holding Force Magnalock®

Recommended for exterior and perimeter doors through which criminals could gain entrance to cause substantial economic loss.

**Features:**

- Instant release circuit - no residual magnetism
- Fully sealed electronics - tamper proof and weatherproof
- Mounted using steel machine screws into blind finishing nuts
- Architectural brushed stainless steel finish (US32D/630)
- All ferrous metal surfaces plated.
- Hardware accessories available to configure any opening type include mounting brackets.
- Ten feet [3.05m] of jacketed, stranded conductor
- Automatic dual voltage - no field adjustment required
- Also available in Conduit and Face Mount models
- Universal threaded conduit fitting is 1/2" female 3/4" male
- 1200 lb. holding force with auto dual voltage

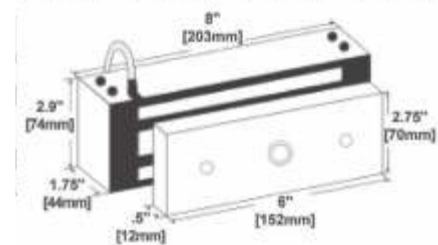
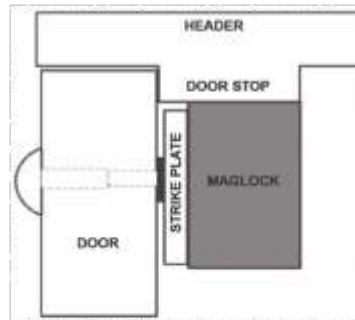

The M32 requires 2.25 inches of flat mounting space

**Specification Data**

- Holding Force: 1,200 lbs. [544 Kg.]
- Current Draw and Voltage: 250mA at 12VDC; 125mA at 24VDC
- Operating Temperature: -40 to +140F [-40 to +60C]
- SEM62 Magnet 12/24VDC
- SEM62F Magnet 12/24VDC Face Mount
- SEM62FG Magnet 12/24 Face/Conduit
- SEM62G Magnet 12/24 Conduit Fit

### Mortise Keyswitch Momentary (less cylinder)



SEMK-SPDT

**ELECTROMAGNETIC LOCKS — continued**

**Stop Filler Plate (SFP) Electromagnetic Locks**

- Used to fill or extend a door stop
- Creates a flat mounting surface for the maglock
- Available in 3/8, 1/2, and 5/8 inch thickness, all 1 1/4" wide

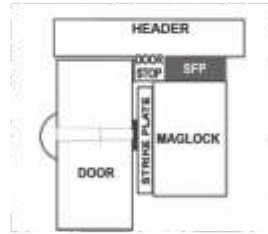

SEFP-1/2BK-8

1/2" Black FP

**Aluminum Spacer Bracket (ASB)**

- The Aluminum Frame Shim Bracket is for use with aluminum frame glass doors. The bracket spaces the magnet body down 1/2" to clear the blade stop and provides alternate mounting hardware for the strike plate as with the magnet body spaced down, the standard sex bolt can interfere with the glass.
- Used when a blade stop requires the Maglock to be lowered
  - Comes pre-drilled (lock specific) for the mounting bolts and wire
  - Provides a blind nut for surface installation of strike

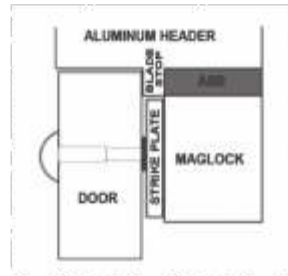

SEASB-32BK M32 Black - 8"  
SEASB-32CL M32 Clear - 8"  
SEASB-62BK M62 Black - 8"  
SEASB-62CL M62 Clear - 8"

**Concrete Wood Bracket (CWB)**

- The Concrete/Wood Frame Bracket is used on concrete filled or wood door frames. On concrete frames, the bracket anchors to the frame via sheet metal screws and the magnet mounts to the bracket via machine screws. The bracket includes a central splice area and avoids the problem of drilling a wireway through the concrete. On wood frames, 4 wood screws are employed to penetrate deeply into the header.
- Used on wood or concrete filled metal frames
  - Provides a concealed wire chamber

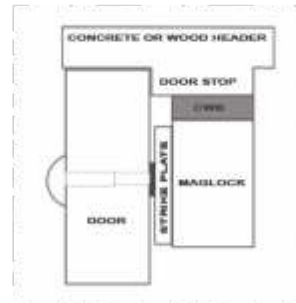

SECWB-32CL M32 Clear - 8"  
SECWB-62CL M62 Clear - 8"

**Universal Header Bracket (UHB)**

- The Universal Header Bracket is used to extend a narrow header (often found on aluminum frame glass doors) to permit mounting of the Maglock. The bracket is positioned either to extend 1" or 1 1/2" and also serves to conceal the hookup cable within its hollow interior. Model UHB works with Model 32 or 62 series Maglocks. With a finish suffix of "CL" for clear anodized aluminum.
- Used to extend the header 1 to 1 1/2 inches
  - Provides a concealed wiring chamber

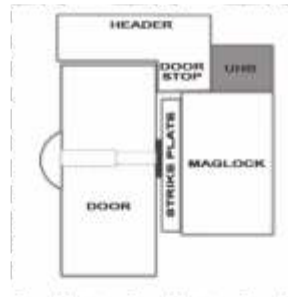

SEUHB-CL-8 Bracket Clear 9 1/2"

**Z Brackets**

- Z Brackets are separately available for the 32, 62 series "F" version Maglock and allow mounting on an inswinging door. The Z Bracket includes a cover which gives the installation an attractive finished appearance.
- Used on inswing doors with the "F" type Maglock. 8 3/8" length
  - Includes a dress cover

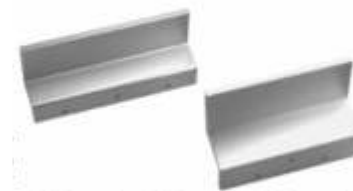
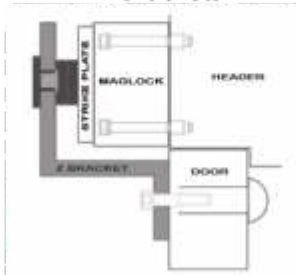

SEZA-32/62CL M32/M62 Clear



**M670 & M680 MAGNALOCK®**

**M670 SERIES**



**DIMENSIONS**

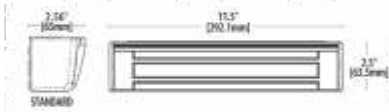

**HOLDING FORCE: 1100 LBS.**

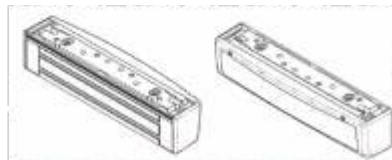

SEM670

M670 MagnaLock

**FEATURES OF M670 & M680**



Integrated Video Surveillance Camera



Integrated Adjustable Motion Detector

- Bracket mounting provides the easiest install for outswinging doors
- Autosensing dual voltage with microprocessor technology
- Size optimized for use with door closers
- Innovative install templating for an effortlessly accurate alignment between magnet and armature plate
- LED visual locked status with configurable red/green color output
- Wire chamber anti-tamper switch
- Efficient, low power usage
- MagnaCare Lifetime Replacement No Fault Warranty

**M680 FEATURES**

- BondSTAT lock bond sensor - Patented
- Adjustable automatic relock timer (0-30 seconds)
- Integrated door position switch
- Optional integrated video surveillance camera (112° angle, supports BNC connection, color or black & white)
- Optional integrated passive infrared motion detector

**M680 SERIES**



**DIMENSIONS**

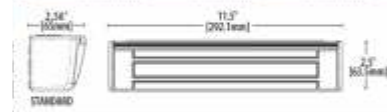

**HOLDING FORCE: 1100 LBS.**

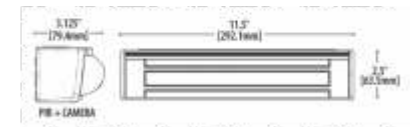

SEM680EBOX

M680 Eco Maglock  
1200 LBS

**MAGLOCK**



- Compact size and light weight.
- Low current draw for 12 to 24 volt AC or DC.
- Integrates with existing access control devices.

**MM15 MAGLOCK**

The MS Maglock provides remote access and exit control of internal and external wood, hollow metal and aluminum doors. The MS Maglock is designed with tow hardened steel mandibles, which are spring loaded to clamp on the armature in the event of a forced entry attempt.

The MS Maglock has a holding force of 4000 pounds when installed with the supplied mounting plate and screws. The revolutionary design allows the Maglock to run on voltages from 12 to 24 AC or DC. The MS Maglock is fail-safe, but can be installed with a battery backup power supply. Available accessories allow the Maglock to be installed on in-swinging as well as out-swinging doors.

SEMM15

SESFP-1/2BKMM15

SESFP-1/2CLMM15

MAGLOCK

1/2" Filler Plate

1/2" Filler Plate

**ELECTRO-MECHANICAL LOCKS**

**UnLatch Strike (UNL)**

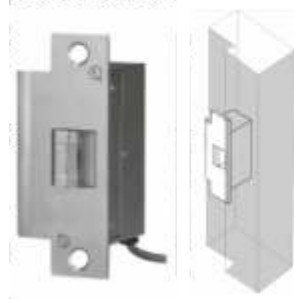
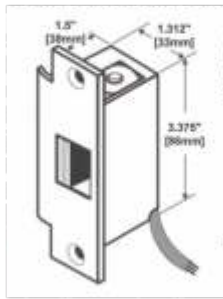

Securiton's UnLatch is a completely new type of electric door releasing device which sweeps away the limitations inherent in traditional electric strike designs. The UnLatch screws into the existing doorframe in seconds. There is no need for routing a special cut-out.

- Features:
- Fits standard ANSI 4 7/8" strike cutout
  - No cutting or altering of the jamb required
  - Motorized, no solenoids
  - Fully concealed installation
  - Maintains dead-latch function at all times
  - Continuous duty. Releases under pre-load
  - Latch status sensor is standard (SPDT)

**Application** - UnLatch is for any application where an electric strike would be used for a cylindrical/tubular lockset. UnLatch supports full dead latch function, releases under pressure and includes a latch status monitoring output.

- SEUNL-12 Unlatch 12VDC  
SEUNL-24 Unlatch 24VDC

**TOUCH SENSE DEVICES**

**Touch Sense Bar (TSB-3)**



**Features and Benefits**

- Standard length: 36"
- Activates a DPST 2 Amp rated relay when touched which will allow free egress or initiate the delay on an exit delay timer
- Backup push button
- 16 ft. [4.8m] 22AWG 6 conductor cable and stainless steel armored door cord
- Operates on either 12 or 24 VDC

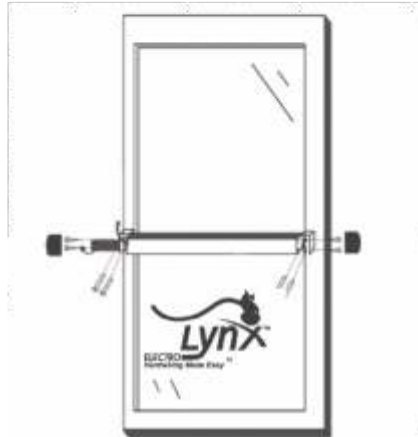

On magnetically locked, non fire-rated doors, most building codes require an exit device that does not require any special tools or knowledge. The simple act of touching the bar (even through gloves or clothing) trips an electronic sensor which immediately releases the lock. Having no moving parts, it does not suffer mechanical wear and no pressure is required for use which provides superior egress safety for frail or disabled persons.

- SETS-BK Bar-Black 36"  
SETS-CL Bar-Clear 36"  
SETS-BCA Mounting Base  
SETS-5 Replacement Sensor (TSB-1)



**Dual Sense Bar (DSB)**

Designed to address current building and life safety codes. It features two independent switch circuits to release the lock. Simply touching the bar or engaging its mechanical movement will allow free egress.

For indoor use only, the DSB can be installed on metal, aluminum or wood doors.



**Electromechanical Bar (EMB)**

Pushing the bar activates internal switches which release the lock. Optional waterproof switches are available which allows the EMB to function in outdoor applications.

Meets "no special tools or knowledge" code requirements.

- SEDSB-BK Bar-Black 36"  
SEDSB-CL Bar-Clear 36"

**Aluminum Spacer Bracket (ASB)**

The remarkable SP-1 uses Securiton touch sensing technology to create a push panel with no moving parts. It operates with a simple touch. The internal timer will operate the unit for up to 25 seconds. It features 1 Amp DPST contacts and has a mechanical redundant backup switch.

It has brushed stainless steel face plate, surface mount plastic backbox and 16ft. cable. Surface mounting is necessary for touch sensing as the plate must be isolated from the wall. The unit is oversized so that it can be mounted over a single gang cutout and mounting hole positions allow use of the standard female holes in a single gang cut-out.

A three part vinyl decal is included to provide the appropriate prompt to the user and a red LED is incorporated in the backbox which illuminates when the unit is touched.

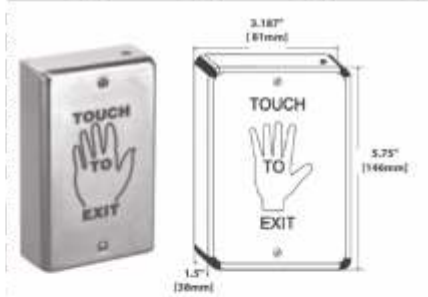

DPST 2 Amp rated relay, internal 0-25 second timer & built in redundant button

**Specification Data:**

- Current Draw: 40mA at rest, 25mA releasing
- Voltage: 12 or 24 VDC
- Operating Temperature: +32 to +110F [0 to +43C]
- Warranty: MagnaCare Lifetime Replacement

- SESP-1 Touch Sense Plate



## GATE LOCKS & KITS



**SEFMK-SL**

**SEFMK-SW**

*These pre-packaged kits will work with the majority of sliding and swinging gate applications. The sliding gate kit used with the GL1 will function when post separation is between 3 3/4". The sliding gate kit used with the M62FG will function when post separation is between 1" & 2 1/4" and permits use with the SASM. The swinging gate kit will function properly with either the GL1 or M62FG where the gate post and fence post separation is between 1" & 2 3/4".*

**The FMK-SL contains:** FMB1, FMB2, FMB3, FMB4, FMB9-4 and all necessary mounting hardware.

**The FMK-SW contains:** FMB1, FMB2, FMB5, FMB6, FMB7, FMB9-4 and all necessary mounting hardware.

SEFMK-SL	Sliding Gate Kit
SEFMK-SW	Swinging Gate Kit
SEGL1-FL	12/24VCD - Fail-Locked
SEGL1-FS	12/24VDC - Fail-Safe

## DIGITAL ENTRY SYSTEMS

### DK-12 Digital Keypad

The DK-12 is a one piece unit designed for lower security requirements. While primarily intended for indoor operation, an optional rain cover

(WCC) and gasketed backbox (WBB) allow reliable use for exterior areas not directly exposed to rain or snow.



**Features:**

- Stainless steel backplate with 12 illuminated keys (10 digits + "E" and "R" keys)
- One piece digital keypad specifically designed for control of electric locks
- Easy to install with simple hand tools

### SEDK-12 Digital Keypad System

- Operates on low voltage AC or DC current
- Audible keystroke echo
- Single gang, stainless steel plate w/plastic backbox
- 99 user code capability which is programmable from the keypad
- Passage mode and Lockout mode
- 5 Amp SPDT timed, control relay output
- Red and Green LEDs are visible indicators
- Yellow LED provides programming prompt
- True 10 digit operation
- Optional weather cover available
- Request to Exit (REX) input

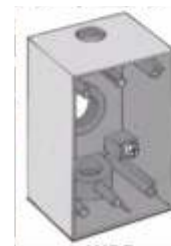

**WBB**



**WCC**

- |       |                  |
|-------|------------------|
| SEWBB | Weather Back Box |
| SEWCC | Cover Clear      |

**Specification Data:**

- Current Draw and Voltage: 70mA, 12 or 24VDC
- Operating Temperature: -10 to +140F Maximum - 30VDC or 300VAC switched voltage
- Shipping Weight: 1 lb.

### DK-26 Digital Keypad



**Features:**

- Cast stainless steel with 11 EPDM rubber keys
- Weather proof and vandal resistant
- Mounts on a narrow mullion
- True 10 digit operation (keys are not paired)
- Digital Keypad System circuit board mounts in a metal enclosure and provides for 59 multiple users
- User code and/or hard code disable feature
- 5 Amp DPDT relay output for lock control and alarm shunt, camera call-up or other device interface, REX input
- 16 ft. [4.8m], 12 conductor, 22 gauge keypad cable
- 3 LEDs and a bell button

**Specification Data:**

- Current Draw:
- 7mA@ rest, 160mA active, 12VAC or VDC
- 20mA@ rest, 190mA active, 24VAC or VDC
- Voltage: 12 or 24 VDC
- Operating Temperature: CPU +32 to +158F [0 to +70C]
- Keypad -22 to +158F [-30 to +70C]
- MagnaCare Lifetime Replacement Warranty

- |            |                      |
|------------|----------------------|
| SEDK-26BK  | Black (59 Users)     |
| SEDK-26PBK | Black (Pad Only)     |
| SEDK-26PSS | Stainless (Pad Only) |
| SEDK-26SS  | Stainless (59 Users) |



**DIGITAL ENTRY SYSTEMS - (Continued)**



**DK-37SS Digital Keypad**

*Features:*

- Weigand
- Single Gang
- Satin Stainless

SEDK-37SS Narrow Stile Digital Keypad

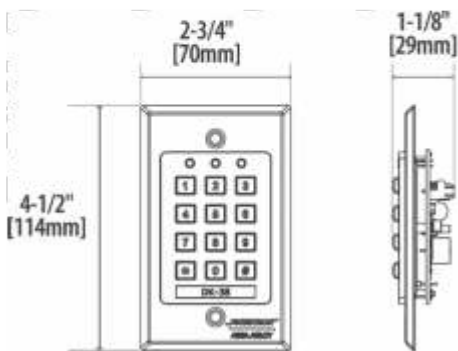

**PUSH BUTTONS (PB)**

**2" Square Emergency Exit Green Button**



4.5" [114mm]

2.75" [70mm]

SEEEB2 2" Green Button

Securitron integrates a 30 second timer function into two existing button designs. for single gang applications. The resultant package integrates with motion detector – like Securitron's model XMS – to provide code legal exit on Access Controlled Egress Doors.

**1 x 3/4" Rectangle Emergency Exit Green Button, Narrow Stile**



4.5" [114mm]

1.75" [70mm]

SEEEB3N 3/4" Green Button

Securitron integrates a 30 second timer function into two existing button designs. Model PB3E becomes the model EEB3N for narrow stile mounting. The resultant package integrates with motion detector – like Securitron's model XMS – to provide code legal exit on Access Controlled Egress Doors.

## POWER SUPPLIES



### Boxed Power Supply (BPS)

The BPS Series DC Power Supplies include battery charging capability with capacities from one Amp.

**Application** - Recommended where an interface with a fire alarm system or battery backup is needed. All BPS models are UL Class 2 listed, allowing for wire runs without the use of conduit from power supply to door.

SEBPS-12-1	12VDC 1 AMP
SEBPS-24-1	24VDC 1 AMP
SEBPS-12/24-1	12/24VDC 1 AMP



### Plug In DC Power Supply (PSP)

**Application** - DC units in two versions: 12 volts @ 700mA max. capacity (model PSP-12) and 24 volts @ 350mA max. capacity (model PSP-24). Internal thermal fuse. 16 ft. output cable is included. PSPs are ideal for powering a wide range of DC devices.

SEBPS-12	PLUG-IN 12DC
SEBPS-24	PLUG-IN 24DC

#### Specification Data

Capacity and Voltage:  
PSP-12: 12VDC, 700mA output  
PSP-24: 24VDC, 350mA output  
Power Input: 110VAC

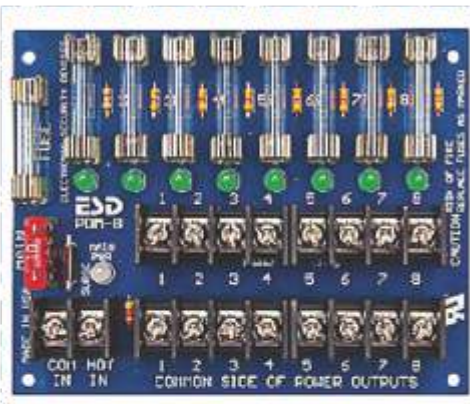

### Power Distribution Boards

SEPDB-8C1R	POWER DISTRIBUTION BOARD
SEPDB-8C2	POWER DISTRIBUTION BOARD
SEPDB-8F2	POWER DISTRIBUTION BOARD
SEPDB-8F8R	POWER DISTRIBUTION BOARD

POWER SUPPLIES & ACCESSORIES

**Battery 12VDC/24VDC 5 Amp Hour**

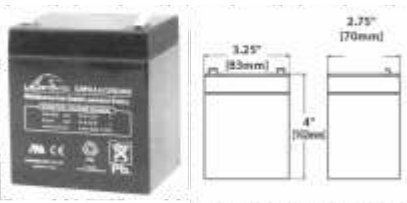

**Features:**

- Compliment the BPS series power supplies
- Applications where the doors must not open in the event of a power failure

**B-12-5** Battery 12VDC 5 Amp Hour  
**B-24-5** Battery 24VDC 5 Amp Hour

**SEB-12-5** Battery 12VDC  
**SEB-24-5** Battery 24VDC

**Prime Time Digital Timer (DT-7)**

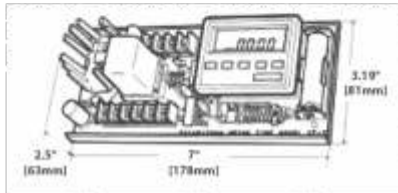
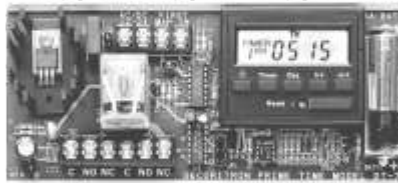

**APPLICATION** - Used to turn electric locks or other security systems on and off at programmed times.

**Features:**

- 7-day digital timer
- 10 Amp DPDT relay can be operated in toggle or pulse mode
- 12 programmed on/off times set daily (6 on, 6 off), on selected days, or on blocks of days
- "First Man In" feature delays operation until an external switch changes state and automates holiday programming in many applications
- 12 or 24 VAC or VDC
- AA battery provides backup to the display module program memory

Prime Time 7 Day Digital Timer

**DT-7**  
**SEDT-7** 7 Day Digital Timer

**Time Mate Timer (TM-9)**

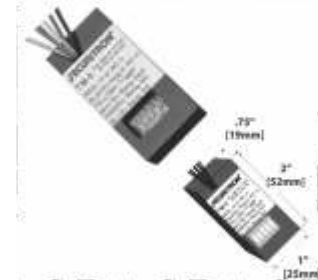

**Application** - When used with a momentary keyswitch or pushbutton, the TM-9 will unlock a door for the timer's pre-set time.

**Features:**

- Miniature timer extends momentary switches up to 36 seconds
- Commonly used in outlet boxes with key switches or push buttons
- Fits in the backbox or can be mounted separately with double stick tape
- 3 Amp SPDT relay energizes for 2 to 36 seconds
- Time setting is selected by DIP switches rather than by a pot
- Applications include releasing electric locks and shunting alarm contacts
- 12 or 24 VDC

**SETM-9** Timemate Timer

**Concealed Power Transfer**



The Concealed Electrical Power Transfer CEPT unit is designed to provide a secure multiple wire power and/or data transfer between a door frame and door. The unit mounts directly between the frame and door along the hinged edge.

**SECEPT-10** Power Transfer

**Inductive Coupling Power Transfer**



**SEICPT** Powerjump Std Black

**Plug-In Transformer**

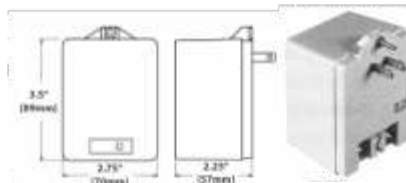

**Features:**

- AC plug-in transformer
- TP-12-3** Transformer, Plug In 12VAC-3 Amp  
**SETP-12-3** Power Supply (40VA)

**Exit Motion Sensor (XMS)**

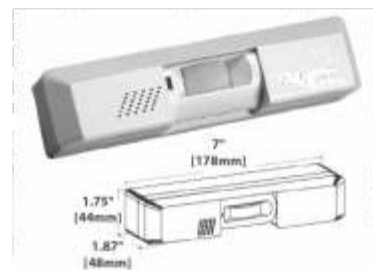

**Application** - The XMS Passive Infrared Request-to-Exit Device is a motion detector specifically designed to reliably release magnetic locks. A person approaching the door is "seen" by the motion detector just before reaching the door.

**Features:**

- Passive Infrared Request-to-Exit Device
- Designed to reliably release magnetic locks
- Automatically cuts power to the lock, allowing the individual to exit without even realizing that the door is secured

**SEXMS** Motion Exit Detector



**Magnetic Oxide Varistor**  
**SEMOV**



## HINGES

SD = Standard Duty HD = Heavy Duty



### Geared Concealed Continuous Hinges

*Features:*

- Proven to withstand 25 million cycles — equal to more than 50 years of use on the average high-traffic door
- Concealed mount. No mortise required
- For new construction or renovation
- Requires 5/16" clearance at hinge side between door and frame
- Thread-Forming fastener standard

SHSL11-HD-83-BRONZE  
 SHSL11-HD-83-CLEAR  
 SHSL11-HD-95-CLEAR  
 SHSL11-SD-83-BRONZE  
 SHSL11-SD-83-CLEAR

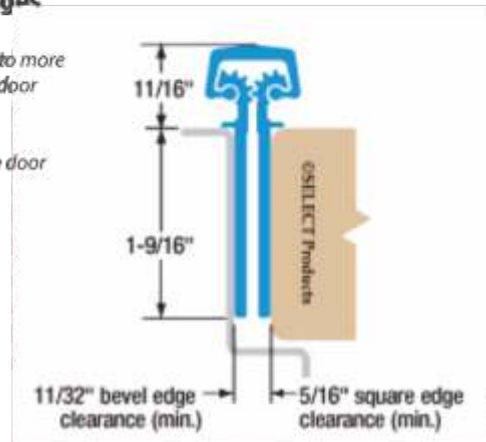

### Geared Full Surface Continuous Hinges

*Features:*

- The perfect solution for renovation (retrofit) or new construction
- Mounts on door face and frame face
- Tamper-resistant, removable door leaf cover
- Thread-Forming fastener standard

SHSL57-HD-83-BRONZE  
 SHSL57-HD-83-CLEAR  
 SHSL57-HD-95-BRONZE  
 SHSL57-HD-95-CLEAR  
 SHSL57-SD-83-BRONZE  
 SHSL57-SD-83-CLEAR  
 SHSL57-SD-95-BRONZE  
 SHSL57-SD-95-CLEAR

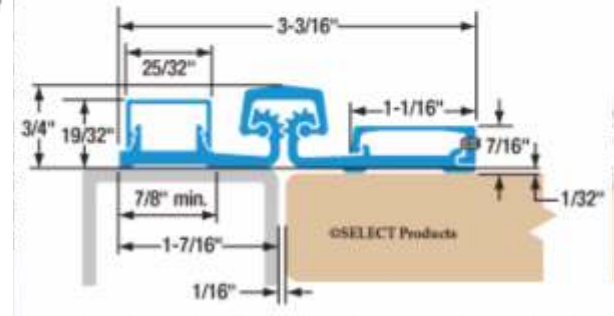

#### Self-Drilling Screws

SHIFTS 12-24 3/4 BRSD  
 SHIFTS 12-24 3/4 CLSD  
 SHIFTS 14-24 7/8 NPSD

**Ask us about Special Order Models!**

Do you have a specific project? Call us today!

**FILE CABINET LOCK KITS**

**Signore Style**

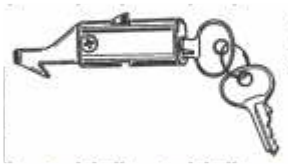

SR2151-KA-K31 Sub. KA #K31  
SR2151-KD100 Sub. Keyed Different

**Holga Style**

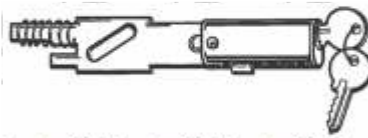

SR2162-KA-K21 Keyed Alike #K21

**Global #Lk26 Style**



SR2176-KA-K11 Keyed Alike #K11  
SR2176-KA-K12 Keyed Alike #K12  
SR2176-KD100 Keyed Different

**Hon® F24 & F28 Style**

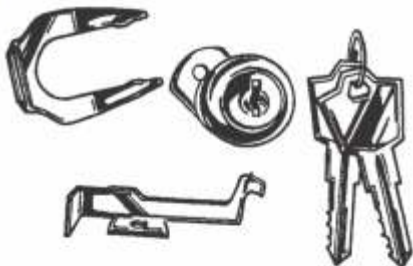

SR2185-KA-1 Keyed Alike #1  
SR2185-KA-2 Keyed Alike #2  
SR2185-KA-3 Keyed Alike #3  
SR2185-KA-4 Keyed Alike #4  
SR2185-KA-5 Keyed Alike #5  
SR2185-KA-6 Keyed Alike #6  
SR2185-KA-7 Keyed Alike #7  
SR2185-KA-8 Keyed Alike #8  
SR2185-KA-9 Keyed Alike #9  
SR2185-KA-10 Keyed Alike #10  
SR2185-KD100 Keyed Different  
SR2185E Adapter Plate Steel

**Hon® F26 Style**

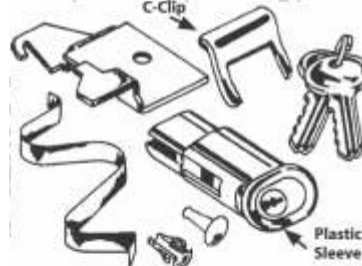

SR2190-KA-1 Keyed Alike #1  
SR2190-KA-2 Keyed Alike #2  
SR2190-KA-3 Keyed Alike #3  
SR2190-KA-4 Keyed Alike #4  
SR2190-KA-5 Keyed Alike #5  
SR2190-KA-6 Keyed Alike #6  
SR2190-KA-7 Keyed Alike #7  
SR2190-KA-8 Keyed Alike #8  
SR2190-KA-9 Keyed Alike #9  
SR2190-KA-10 Keyed Alike #10  
SR2190-KD100 Keyed Different  
SR2190E Plastic Sleeve  
SR2190G C-Clip

**Hon® Lateral File Lock**



SR2188-KA1  
SR2188-KA2  
SR2188-KA3  
SR2188-KA4  
SR2188-KA5  
SR2188-KA6  
SR2188-KA7  
SR2188-KA8  
SR2188-KA9  
SR2188-KA10  
SR2188-KD100

**Anderson Hickey**

- Fits Pre - 2/99 Cabinets
- Also Fits Premier Files



SR2194-KA-2 Plunger Style KA #2  
SR2194-KA-4 Plunger Style KA #4  
SR2194-KD50 Plunger Style KD

**Anderson Hickey**

- Fits Cabinets MCG After 2/99
- Also Fits Premier & Globe
- Does Not Fit HON® or Global



SR2197-KA-2 Cam Style KA #2  
SR2197-KA-4 Cam Style KA #4  
SR2197-KD100 Cam Style KD

**T-Handle With Easy-Mount Base**

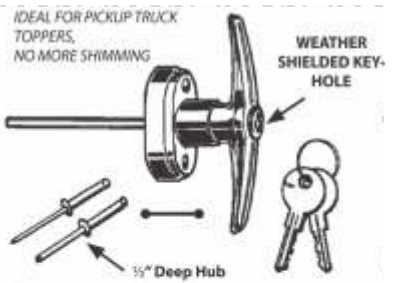







SR2205-KA-CH751  
SR2205-KD





**AMERICAN MOTORS**

<p><b>Case Cap, Small</b></p>  <p>ST320318</p>	<p><b>Case Cap, Large</b></p>  <p>ST320376</p>	<p><b>Padlock Bolt</b></p> <p>ST7018517 PADLOCK,BOLT 2.0 GM75</p>
---	---	---

**FORD**

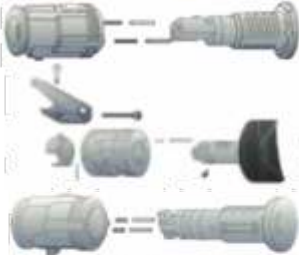
<p><b>Ignition Locks</b></p>  <p>707624 707592</p> <p>ST707624 <i>Uncoded, 8 cut "LSP" 1996-Current</i> ST707624C <i>Ign LSP Coded</i> ST707592 <i>Ign LSP</i></p>	<p><b>Door Locks</b></p>  <p>703369</p> <p>ST608433 <i>Uncoded, 1966-1980</i> ST703369 <i>Bronco, F150, Ranger</i> ST703362 <i>F150 Full Size 97-Current</i></p>	<p><b>Case Cap</b></p>  <p>322257 322534 322535</p> <p>ST322257 <i>(door)</i> ST322534 <i>Black</i> ST322535 <i>Chrome</i></p>
<p><b>Ignition Tumblers</b></p>  <p>322251</p> <p>ST322251 #1 ST322252 #2 ST322253 #3 ST322254 #4 ST322255 #5 ST46970 <i>Springs</i></p>	<p><b>Door Tumblers</b></p>  <p>322261</p> <p>ST322261 #1 ST322262 #2 ST322263 #3 ST322264 #4 ST322265 #5 ST46969 <i>Springs</i></p>	<p><b>5 Cut Pin Tumbler</b></p>  <p>ST83231 #1 ST83233 #3 ST83234 #4 ST83235 #5 ST46652 <i>Springs</i></p>

**CHRYSLER**









<p><b>Ignition Locks</b></p>  <p>593448 700142</p> <p>ST701757 <i>Coded, 92, All Except Viper</i></p>	<p><b>Ignition Locks Service Package</b></p>  <p>702418 703719 702417 702788 704650</p> <p>ST702417 <i>1994 Black Groove 84</i> ST702418 <i>95's</i> ST702788 <i>95's</i> ST703719 <i>LH Body w/Sidebar 98-00</i> ST704650 <i>CHRY IGN LSP</i> ST704650C <i>CHRY IGN Coded</i></p>	<p><b>Door</b></p>  <p>ST704275C <i>Door (2) Coded</i></p>
<p><b>Parts</b></p>  <p>321848</p> <p>ST46648 <i>Tumbler Spring</i> ST46650 <i>Tumbler Spring</i> ST321848 <i>Case Cap</i> ST46994 <i>Tumbler Spring</i></p>	<p><b>Ignition Tumbler Spring Double Bitted</b></p>  <p>ST322691 #1 ST322692 #2 ST322693 #3 ST322694 #4 ST56115 <i>Springs</i></p>	<p><b>Chrysler Glovebox Tumbler Snap In - Double Bitted</b></p>  <p>ST321761 #1 ST321762 #2 ST321763 #3 ST321764 #4 ST46890 <i>Springs</i></p>



### GENERAL MOTORS

#### IGNITION LOCKS

**Coded**

-  **ST605532** Dash Mounted, 1966-Current
-  **ST607893** GM Ign Lk Snap-In Chrome
-  **ST700754** Standard, 1986-Current
-  **ST701285** Vats, Cad, Sector Gear, 89Current
-  **ST701286** Vats, Dual Clip, 90-Current, C-BO
-  **ST701398** Univ, 1979-Current
-  **ST701400** Univ, Blk, 1979-Current
-  **ST703605** CSS Column Double-Bitted VAT

- ST707758C** GM Ign Coded
- ST707835C** GM Ign Coded

**LSP**

-  **ST7009992** GM LSP
-  **ST702671** CSS Column 1995-Current
-  **ST704602** CSS Column RFID
-  **ST703225** Mod Passlock J-Body 1996
-  **ST703648** Modular Passlock 1997-99
-  **ST704600** MRD, Large Knob
-  **ST703602** Full Repair Kit
-  **ST705383** Passlock Cavalier, Sunfire
-  **ST707835** Passlock GM Truck
-  **ST709271** Ign LSP GMT 920/921

**Door Lock Service Package**

**ST607868**  
Uncoded, Short Cyl. Length 7/32"



**ST702674**  
Door LSP



**Door Lock Cylinders**

Uncoded, Short Cyl. Length 7/32"



**ST591301**

**Door and Deck Set  
Coded, Standard Cylinders**

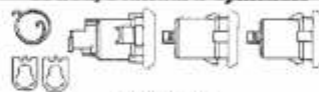

**ST608333**

**Door - LSP Coded**



**ST706592C**

**Repair Kit**



**ST7006014**

**Coded Lock Sets**







**ST7012943**



**ST7012945**

**GENERAL MOTORS**

<p><b>Case Caps</b></p>  <p><i>Door, Std</i> 320395</p>  <p><i>Door, Black, Standard</i> 322658</p>	<p><b>Double-Bit</b></p>  <p>ST323121 Tumblers ST323122 Tumblers ST323123 Tumblers ST323124 Tumblers ST56028 Spring ST323230 Retainer</p>	<p><b>Tumblers and Springs Ignitions, Doors, Trunks</b></p> <p>ST46648 Spring ST322051 GM #1 ST322052 GM #2 ST322053 GM #3 ST322054 GM #4 ST322055 GM #5 ST321127 Retainer</p>
<p><b>Shutters</b></p>  <p>ST59995</p>	<p><b>GM Tumblers</b></p> <p>ST322521 ST322522 ST322523 ST322524</p>	<p><b>Tumblers - Door / Deck</b></p>  <p>ST322241 Tumbler #1 ST322242 Tumbler #2 ST322243 Tumbler #3 ST322244 Tumbler #4</p>
<p><b>Parts</b> ST47522 Gasket, Door</p>		

**Pinning Kit**  
*Double Bitted - For GM 94 and Up*  
ST702767

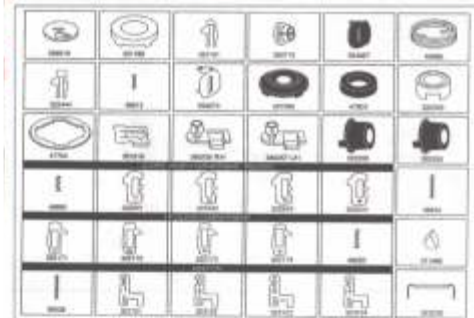

**GM 93 Groove Kit**  
ST7006412

Both boxes included.



**General Motors 93 Groove - Box 1**

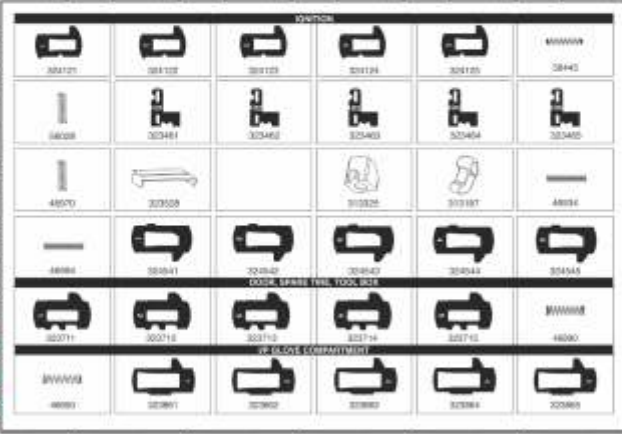

**General Motors 93 Groove - Box 2**

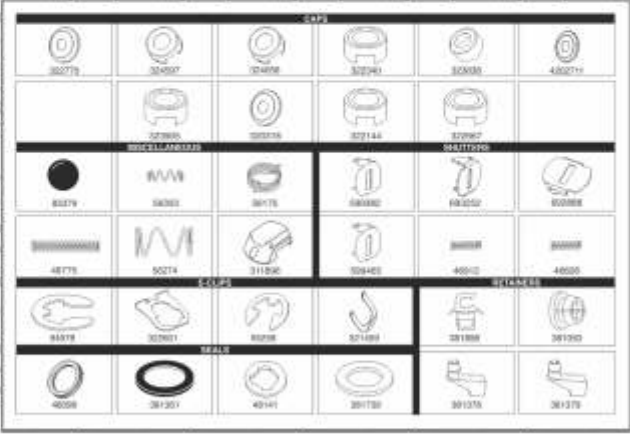

REMOTE KEYS



**3 Button Remote Key**  
 ST5913596 GMC Terrain  
 ST5913598 Chev Camaro/Equinox  
 ST5919939 Chev Uplander '05-'06



**4 Button Remote Key**  
 ST5912543 Camaro '10  
 ST5912547 GMC Terrain  
 ST5912555 Buick Lacrosse  
 ST5912558 Buick Lacrosse  
 ST5913396 GM



**5 Button Remote Key**  
 ST5912545 Camaro '10  
 ST5912548 GMC Terrain  
 ST5912556 Buick Lacrosse  
 ST5912559 Buick Lacrosse  
 ST5913397 GM



**Ford Peps Fob & Emergency Key**  
 ST5914119 Ford 2010 Taurus



**GM Flip Key Replacement & Fixture**  
 ST5921873 Flip Key Replacement



**GM Flip Key Replacement & Fixture**  
 ST5915037 Flip Key Replacement  
 ST7017699 GM Flip Key Fixture

Deck Lock Service Package



700182



700508



701129

ST700182 Uncoded, Std, use w/ Vertical Clip  
 ST700919 Service Pkg., Deck, GM  
 ST701129 GM Deck LSP

Tailgate Locks



701928

ST701928 U-Body Van, 1990-1996

SIDEMILL KEY BLANKS

ST7013237 SIDE MILL NON-FLIP-TRANSPONDER



ST5927928 SIDE MILL CHEVY LOGO 10 CUT

ST4212475 SIDE MILL KV (BACKUP) KEY  
 ST4225455 GM LOGO COINED SIDEMILL KEY  
 ST5928092 CHEVROLET LOGO SIDE MILL KEY  
 ST5928094 GMC LOGO SIDE MILL KEY  
 ST5928275 GM LOGO CIRCLE PLUS SIDE MILL  
 ST5915237 SIDE MILL PLAIN RFID

NON-TRANSPONDER KEY BLANKS



ST5928820 GM LOGO 93 GRV PK3 KEY  
 ST5928821 GM LOGO 75 GRV PK3 KEY  
 ST5928822 GM LOGO 88 GRV NON-TRANSPONDER  
 ST5928823 GM LOGO 93 GRV PK3+ KEY  
 ST5928824 GM LOGO 93 GRV NON-TRANSPONDER  
 ST5928825 GM LOGO 75 GRV PK3+ KEY



**LUBE PRODUCTS**

SU11006	Super Lube Dri-Film 5.25 OZ.
SU21006	Super Lube Synthetic Grease
SU31110	Super Lube Aerosol 11 OZ.
SU51010	Super Lube Precision Oiler Pen
SU85011	Super Lube Syncopen Penetrant

**LUBRICANTS**



**Superior Lubricant Aerosol**

*Features:*

- *Twice the lubricating power of most competitive brands*
- *Its light viscosity allows for deep penetration into hard to reach moving parts*
- *High grade petroleum oils and Teflon® provide optimum lubrication under extreme temperatures (-60 to 475F) and humidity*
- *Ideal for loosening rusted and corroded nuts and bolts*
- *Excellent for lubricating chains and all pivot points*

TF20005	6 OZ
TF20006	12 OZ
TF20009	4 OZ
TF0023008	Rapid Cleaner Dry Degreaser

**GRADE 1 LEVERS & KNOBS**

**Cylindrical Lever Locksets  
with 3 1/2" Rose Diameter**



With Clutch

• Supplied with a 6 pin cylinder, SC1 keyway, and will accept ASSA, ILCO, MEDECO and SCHLAGE cylinders.

**2 3/4" Backset - Satin Chrome**

UCUSL110S-613-234	Passage
UCUSL110S-626-234	Passage
UCUSL140S-626-234	Privacy
UCUSL150D-SC1-613-234	Entrance
UCUSL150D-SC1-626-234	Entrance
UCUSL170D-SC1-613-234	Classroom
UCUSL170D-SC1-626-234	Classroom
UCUSL173D-SC1-626-234	Class. Sec.
UCUSL180D-SC1-613-234	Storeroom
UCUSL180D-SC1-626-234	Storeroom

**Cylindrical Lever Locksets  
with 3 1/2" Rose Diameter**



With Clutch

• Models prepped for IC core will accept Arrow, Best, Falcon, & KSP cores

**2 3/4" Backset - Satin Chrome**

UCUSL150D-IC-626-234	Entrance
UCUSL170D-IC-626-234	Classroom
UCUSL173D-IC-626-234	Intruder
UCUSL180D-IC-626-234	Storeroom

• Models prepped for LFIC core will accept Schlage cores

**2 3/4" Backset - Satin Chrome**

UCUSL150D-LFIC-626-234	Entrance
UCUSL170D-LFIC-626-234	Classroom
UCUSL180D-LFIC-626-234	Storeroom

**UCIC17-1**                      **6/7 G1 IC Driver**

**Cylindrical Knob Locksets  
with 3" Rose Diameter**



ORBIT

• Supplied with a 6 pin cylinder, SC1 keyway, and will accept ASSA, ILCO, MEDECO and SCHLAGE cylinders.

**2 3/4" Backset - Stainless Steel**

UCK110S-O-630	Passage
UCK140S-O-630	Privacy
UCK150D-O-630	Entrance
UCK170D-O-630	Classroom
UCK180D-O-613	Storeroom
UCK180D-O-630	Storeroom

• Models prepped for IC core will accept Arrow, Best, Falcon, & KSP cores

UCK150IC-630	Entrance
UCK170IC-630	Classroom
UCK180IC-630	Storeroom

**SPRINGLATCHES**



**USL100 Series Grade 1 Levers**

UCG1SL-2-3/4-630
UCG1SL-2-3/8-630
UCG1SLP-2-3/4-630

**DEADLATCHES**



**USL100 Series - Grade 1 Levers**

UCG1DL-2-3/4-630
UCG1DL-2-3/8-630



**K100 Series Grade 1 Knob Locks**

UCG1-2-3/4-DL-626
UCG1-2-3/8-DL-626
UCG1-2-3/8-SL-626



**GRADE 2 LEVERS & KNOBS**

**Cylindrical Lever Locksets**

With Clutch



• 6 pin cylinder supplied SC1 keyway, & will accept ASSA, ILCO, MEDECO and SCHLAGE cylinders.

- |                           |                                    |
|---------------------------|------------------------------------|
| UCUSL2125-605-234         | Passage                            |
| UCUSL2125-613-234         | Passage                            |
| UCUSL2125-CRV-626-234     | Passage                            |
| UCUSL2125-CRV-626-238     | Passage                            |
| UCUSL2125-626-234         | Passage                            |
| UCUSL2125-626-238         | Passage                            |
| UCUSL2425-CRV-626-234     | Privacy                            |
| UCUSL2425-CRV-626-238     | Privacy                            |
| UCUSL2425-605-234         | Privacy                            |
| UCUSL2425-613-234         | Privacy                            |
| UCUSL2425-626-234         | Privacy                            |
| UCUSL2425-626-238         | Privacy                            |
| UCUSL252D-CRV-SC1-626-234 | Entrance                           |
| UCUSL252D-CRV-SC1-626-238 | Entrance                           |
| UCUSL252D-SC1-605-234     | Entrance                           |
| UCUSL252D-SC1-613-234     | Entrance                           |
| UCUSL252D-SC1-626-234     | Entrance                           |
| UCUSL252DSC1-626-238      | Entrance                           |
| UCUSL272D-CRV-SC1-626-234 | Classroom                          |
| UCUSL272D-CRV-SC1-626-238 | Classroom                          |
| UCUSL272D-SC1-605-234     | Classroom                          |
| UCUSL272D-SC1-613-234     | Classroom                          |
| UCUSL272D-SC1-626-234     | Classroom                          |
| UCUSL272D-SC1-626-238     | Classroom                          |
| UCUSL282D-CRV-SC1-626-234 | Storeroom                          |
| UCUSL282D-CRV-SC1-626-238 | Storeroom                          |
| UCUSL282D-SC1-605-234     | Storeroom                          |
| UCUSL282D-SC1-613-234     | Storeroom                          |
| UCUSL282D-SC1-626-234     | Storeroom                          |
| UCUS L282D-SC1-626-238    | Storeroom                          |
| UCUSL250D-SC1-605-234     | Entrance <input type="checkbox"/>  |
| UCUSL250D-SC1-613-234     | Entrance <input type="checkbox"/>  |
| UCUSL250D-SC1-626-234     | Entrance <input type="checkbox"/>  |
| UCUSL270D-SC1-613-234     | Classroom <input type="checkbox"/> |
| UCUSL270D-SC1-626-234     | Classroom <input type="checkbox"/> |
| UCUSL280D-SC1-613-234     | Storeroom <input type="checkbox"/> |
| UCUSL280D-SC1-626-234     | Storeroom <input type="checkbox"/> |

**Cylindrical Lever Locksets**

With Clutch



• Models prepped for IC core will accept cores from Arrow, Best, Falcon, & KSP

- |                      |              |
|----------------------|--------------|
| UCUSL252D-IC-605-234 | Entrance IC  |
| UCUSL252D-IC-613-234 | Entrance IC  |
| UCUSL252D-IC-626-234 | Entrance IC  |
| UCUSL272D-IC-613-234 | Classroom IC |
| UCUSL272D-IC-626-234 | Classroom IC |
| UCUSL282D-IC-605-234 | Storeroom IC |
| UCUSL282D-IC-613-234 | Storeroom IC |
| UCUSL282D-IC-626-234 | Storeroom IC |



CRV

**Cylindrical Knob Locksets**

PLYMOUTH



• 6 pin cylinder supplied SC1 keyway, & will accept ASSA, ILCO, MEDECO and SCHLAGE cylinders.

- |                       |           |
|-----------------------|-----------|
| UCUS105-P-605-234     | Passage   |
| UCUS105-P-630-234     | Passage   |
| UCUS105-P-630-238     | Passage   |
| UCUS405-P-605-234     | Privacy   |
| UCUS405-P-630-234     | Privacy   |
| UCUS53P-P-SC1-605-234 | Entrance  |
| UCUS53P-P-SC1-605-238 | Entrance  |
| UCUS53P-P-SC1-630-234 | Entrance  |
| UCUS53P-P-SC1-630-238 | Entrance  |
| UCUS70P-P-SC1-605-234 | Classroom |
| UCUS70P-P-SC1-630-234 | Classroom |
| UCUS80P-P-SC1-605-234 | Storeroom |
| UCUS80P-P-SC1-630-234 | Storeroom |

**SPRINGLATCHES**

US Series Grade 2 Knob  
USL 200 Series Grade 2 Lever

- |                    |         |
|--------------------|---------|
| UCG2-2-3/4-SL-605  |         |
| UCG2-2-3/4-SL-630  |         |
| UCG2-2-3/8-SL-605  |         |
| UCG2-2-3/8-SL-630  |         |
| UCG2P-2-3/4-SL-626 | Privacy |
| UCG2P-2-3/8-SL-626 | Privacy |

**DEADLATCHES**

US Series Grade 2 Knob  
USL Series Grade 2 Lever



UCG2DI-2-3/8-DL-630 Drive-In Deadlatch  
UCG2DI-2-3/4-DL-630 Drive-In Deadlatch

- |                     |
|---------------------|
| UCG2-2-3/4-DL-605   |
| UCG2-2-3/4-DL-630   |
| UCG2-2-3/8-DL-605   |
| UCG2-2-3/8-DL-613   |
| UCG2-2-3/8-DL-630   |
| UCG2DI-2-3/4-DL-630 |
| UCG2DI-2-3/8-DL-630 |

**BACKSET EXTENSION**

US Series Grade 2 Knob  
USL Series Grade 2 Lever



- |                |                          |
|----------------|--------------------------|
| UC57MM         | Extension for 5" Backset |
|                | Use with 2 3/4" latch    |
| UC57MM GRADE 1 |                          |

Fixed Lever

**GRADE 2 KNOBS & DEADBOLTS**

**Cylindrical Knob Locksets**



ORBIT

• Supplied with a 6 pin cylinder, SC1 Keyway, and will accept ASSA, ILCO, MEDECO and SCHLAGE cylinders

UCUS10S-O-605-234	Passage
UCUS10S-O-613-234	Passage
UCUS10S-O-619-238	Passage
UCUS10S-O-630-234	Passage
UCUS40S-O-605-234	Privacy
UCUS40S-O-609-238	Privacy
UCUS40S-O-613-234	Privacy
UCUS40S-O-619-238	Privacy
UCUS40S-O-630-234	Privacy
UCUS53P-O-SC1-605-234	Entrance
UCUS53P-O-SC1-605-238	Entrance
UCUS53P-O-SC1-609-234	Entrance
UCUS53P-O-SC1-609-238	Entrance
UCUS53P-O-SC1-613-234	Entrance
UCUS53P-O-SC1-619-234	Entrance
UCUS53P-O-SC1-619-238	Entrance
UCUS53P-O-SC1-630-234	Entrance
UCUS53P-O-SC1-630-238	Entrance
UCUS70P-O-SC1-630-234	Classroom
UCUS80P-O-SC1-605-234	Storeroom
UCUS80P-O-SC1-613-234	Storeroom
UCUS80P-O-SC1-630-234	Storeroom
UCUS80P-O-SC1-630-238	Storeroom

• Models prepped for IC core will accept cores from Arrow, Best, Falcon, & KSP

UCUS53IC-O-630-234	Entrance
UCUS70IC-O-630-234	Classroom
UCUS80IC-O-630-234	Storeroom

**Cylindrical Knob Locksets**



ORBIT

• Supplied with a 6 pin cylinder, WRS Keyway, and will accept ASSA, ILCO, MEDECO and SCHLAGE cylinders

UCUS53P-O-WRS-605-234	Entrance
UCUS53P-O-WRS-605-238	Entrance
UCUS53P-O-WRS-609-234	Entrance
UCUS53P-O-WRS-609-238	Entrance
UCUS53P-O-WRS-619-234	Entrance
UCUS53P-O-WRS-619-238	Entrance
UCUS53P-O-WRS-630-234	Entrance
UCUS53P-O-WRS-630-238	Entrance
UCUS80P-O-WRS-605-234	Storeroom
UCUS80P-O-WRS-605-238	Storeroom
UCUS80P-O-WRS-609-234	Storeroom
UCUS80P-O-WRS-609-238	Storeroom
UCUS80P-O-WRS-619-234	Storeroom
UCUS80P-O-WRS-619-238	Storeroom
UCUS80P-O-WRS-630-234	Storeroom
UCUS80P-O-WRS-630-238	Storeroom

**Deadbolts**



6 Way Adjustable Bolt  
SC1 / WRS / KW1 Keyway

USD130-KW1-630	Single
UCD130-SC1-605	Single
UCD130-SC1-609	Single
UCD130-SC1-613	Single
UCD130-SC1-619	Single
UCD130-SC1-626	Single
UCD130-SC1-630	Single
UCD230-SC1-605	Double
UCD230-SC1-609	Double
UCD230-SC1-613	Double
UCD230-SC1-619	Double
UCD230-SC1-630	Double
UCD130-WRS-605	Single
UCD130-WRS-609	Single
UCD130-WRS-619	Single
UCD130-WRS-630	Single
UCD230-WRS-605	Double
UCD230-WRS-609	Double
UCD230-WRS-619	Double
UCD230-WRS-630	Double
UCSCDT-G2	Tailpiece
D130-D130IC	
• Models prepped for IC core will accept cores from Arrow, Best, Falcon, & KSP	
UCD130-IC-613	Single
UCD130-IC-630	Single
UCD230-IC-613	Double
UCD230-IC-630	Double

**BOLTS**



**D Series**

UC9096-605	Grade 2, 6-way Adj
UC9096-609	Grade 2, 6-way Adj
UC9096-613	Grade 2, 6-way Adj
UC9096-630	Grade 2, 6-way Adj



**GRADE 3 KNOBS & DEADBOLTS**

**Cylindrical Knob Locksets**



ORBIT

- 5 pin SC1 keyway, keyed different
- Supplied with adjustable backset latch

UCK310S-O-605	Passage
UCK310S-O-609	Passage
UCK310S-O-619	Passage
UCK310S-O-630	Passage
UCK340S-O-605	Privacy
UCK340S-O-609	Privacy
UCK340S-O-619	Privacy
UCK340S-O-630	Privacy
UCK350D-O-SC1-605	Entrance
UCK350D-O-SC1-609	Entrance
UCK350D-O-SC1-619	Entrance
UCK350D-O-SC1-630	Entrance
UCK380D-O-SC1-605	Storeroom
UCK380D-O-SC1-630	Storeroom



ORBIT

- 5 pin WR3 keyway, keyed different
- Supplied with adjustable backset latch

UCK350D-O-WR3-605	Entrance
UCK350D-O-WR3-609	Entrance
UCK350D-O-WR3-619	Entrance
UCK350D-O-WR3-630	Entrance
UCK380D-O-WR3-605	Storeroom
UCK380D-O-WR3-609	Storeroom
UCK380D-O-WR3-630	Storeroom

**Tubular Knob Locksets**



TULIP

- Medium duty residential tubular grade 3 lockset.
- Adjustable door thickness.
- Interior push button.
- Tulip Knob Design.
- WR3 keyway.
- Keyed Different.
- Adjustable backset U.L. listed latch square corner.
- Square corner full lip strike.
- Designed to install with ease.

UCUS110-T-605	Passage
UCUS110-T-609	Passage
UCUS130-T-605	Privacy
UCUS130-T-609	Privacy
UCUS151-T-WR3-605	Entry
UCUS151-T-WR3-609	Entry

**Deadbolts**



- 4 Way Adjustable Bolt
- Grade 3
- WR3 keyway, 5 pin KD

UCD125-WR3-605	Single
UCD125-WR3-609	Single
UCD125-WR3-613	Single
UCD125-WR3-619	Single
UCD125-WR3-630	Single

- 4 Way Adjustable Bolt
- KW1 keyway, 5 pin KD
- Round Corner Latch & Strike

UCD125-KW1-605	Single
UCD125-KW1-613	Single
UCD125-KW1-619	Single
UCD125-KW1-630	Single

**BOLTS**



D Series

UCG3DB4Wx605 Grade 3, 4-way Adj.



K300 Series  
Grade 3 Knob

UCG3-ADJ-DL-605  
UCG3-ADJ-DL-605-K350  
UCG3-ADJ-DL-609-K350  
UCG3-ADJ-DL-630-K350

- 4 Way Adjustable Bolt
- Removable SC1 keyway cylinder
- Will accept ASSA, ILCO, and Medeco cylinder

UCD125-SC1-605	Single
UCD125-SC1-609	Single
UCD125-SC1-613	Single
UCD125-SC1-619	Single
UCD125-SC1-630	Single
UCD225-SC1-605	Double
UCD225-SC1-609	Double
UCD225-SC1-630	Double



## MORTISE CYLINDER

*"Exclusive Keyway"  
Available to Locksmiths Only!*

**1" MORTISE CYLINDER**  
Solid brass cylinder. Drilled 5, pinned 5.



UC7165UCA2-03-KA2  
UC7165UCA2-26D-KA2  
UC7165UCA2-46-KA2

**1 1/8" MORTISE CYLINDER**  
Solid brass cylinder. Drilled 6, pinned 5.



UC7185UCA2-03-KA2  
UC7185UCA2-26D-KA2  
UC7185UCA2-46-KA2

**1 1/2" MORTISE CYLINDER**  
Solid brass cylinder. Drilled 6, pinned 5.



UC7205UCA1-26D-0B  
UC7205UCA1-46-0B

## RIM CYLINDER

**RIM CYLINDER**  
Solid brass cylinder. Drilled 6, pinned 5.



UC7075UCA10-26D-KA2  
UC7075UCA10-46-KA2

**Parts**

UC006-EV22903-1 Tailpiece for G2 IC Lever  
UC007-LM31202-3 Cylinder Driver for D130-IC

## COMBINATION CYLINDERS

**COMBINATION CYLINDERS**  
Operates Most Grade 1 & 2 Locksets plus Arrow D,E, F, K  
Schlage B100, B200, B400, H Series • 04 & 26D Finish • KD & 0-Bitted  
Solid Brass Plug & Housing • Screw End Cap

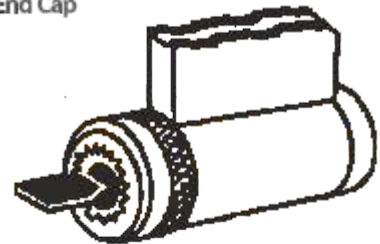
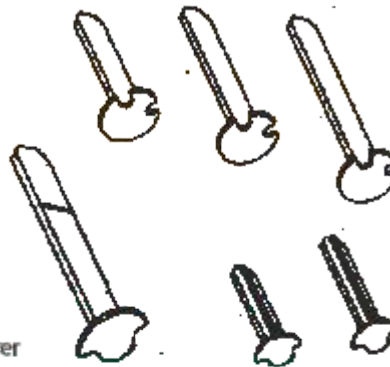

UC15395UCA-26D-0B  
UC15395UCA-26D-KD-A  
UC15995UCA-04-0B  
UC15995UCA-26D-KD-A  
UC15995UCA-26D-0B

## KEYWAY BLANK

**5 Pin with Neuter Head**

UCUCA-5-NS  
UCUCA-6-NS

## DOOR CLOSERS



### Grade 2 Door Closer 1000 Series

- Precision cast aluminum alloy body closer that is designed for high traffic commercial applications.
- Tri-pack for regular, parallel arm and top jamb installation.
- Adjustable sweep, latching speed and back check valves.
- Sized #4 with universal retrofit hole spacing. • Fixed 4 power.
- Non-Handed installation.
- Door Width Maximum: Interior 44", Exterior 48"

Product No.	Description - 1000 Door Closers
UC1000BC-AL	Door Closer Adj Type 9304 - Bf: no Bc: yes Arm: screw
UC1000BC-DU	Door Closer Adj Type 9304 - Bf: no Bc: yes Arm: screw

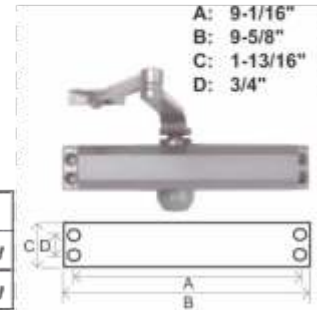

### Grade 1 Door Closer 2000 Series

- Adjustable power cast aluminum alloy body closer that is designed for commercial applications.
- UL A156.4 Grade 1.
- 1 - 4 adjustable power.
- Tri-pack for regular, parallel arm and top jamb installation.
- Adjustable sweep and latching speed valves.
- Delayed action control valve.
- Non-Handed installation.
- Door Width Maximum: Interior 48", Exterior 52"

Product No.	Description - 2000 Door Closers
UC2000-BC/BF-AL	Door Closer 1-4 Type 1601 - Back Check/delayed Acti on
UC2000-BC/BF-DU	Door Closer 1-4 Type 1601 - Back Check/delayed Acti on

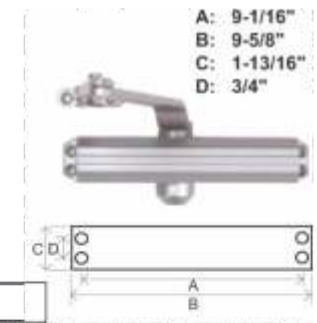

Product No.	Description - 1000 & 2000 Parts
ITTJB-54-AL	1000/2000 Top Jamb Bracket
ITTJB-54-DU	1000/2000 Top Jamb Bracket
IT525-AL	PA Bracket 1000/2000

Product No.	Description - 1000 & 2000 Parts
IT525-DU	PA Bracket 1000/2000
IT547-AL	1000/2000 Flat Drop Plate
IT547-DU	1000/2000 Flat Drop Plate



### Grade 1 Door Closer 3000 Series

- Adjustable power cast aluminum alloy body closer that is designed for high traffic commercial applications.
- UL A156.4 Grade 1.
- 1 - 6 adjustable power.
- Tri-pack for regular, parallel arm and top jamb installation.
- Adjustable sweep and latching speed valves.
- Non-Handed installation.
- Door Width Maximum: Interior 48", Exterior 60"

Product No.	Description - 3000 Door Closers
UC3000BF-AL	Door Closer 1-6 Type 4040 - Bf: yes Bc: yes Arm: slide
UC3000BF-DU	Door Closer 1-6 Type 4040 - Bf: yes Bc: yes Arm: slide

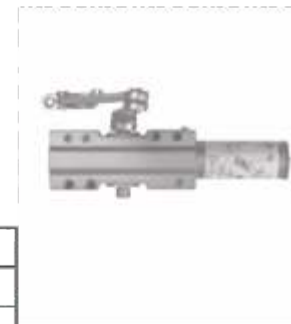

Product No.	Description - 3000 Parts
IT44-18-AL	4400 Drop Plate Pull Side
IT44-18-DU	4400 Drop Plate Pull Side
IT44-18G-AL	4400 Drop Plate Pull Side
IT44-18G-DU	4400 Drop Plate Pull Side

Product No.	Description - 3000 Parts
IT44-18J-AL	4400 Drop Plate Pull Side
IT44-18J-DU	4400 Drop Plate Pull Side
IT44-18PA-AL	4400 PA Drop Plate
IT44-18PA-DU	4400 PA Drop Plate

**DOOR HARDWARE**

**PADDLES**

**Aluminum**

Latchlocks Body Only, Less Strike & Faceplate



- UCDL45101 LH 31/32 B.S.
- UCDL45102 RH 31/32 B.S.
- UCDL45103 LH 1 1/8" B.S.
- UCDL45104 RH 1 1/8" B.S.

**NS Latches**

- UCDL45105AD  
NS Latch 31/32" RH/LH AL/DU
- UCDL45106ADJ  
NS Latch 1 1/8" RH/LH AL/DU

**Faceplates for Latch Locks**



- UCDL4511-AL Flat
- UCDL4511-DU Flat
- UCDL4512-AL Radius
- UCDL4512-DU Radius

**Faceplates for Narrow Stile Deadbolts**



- UCDB1851-AL Flat
- UCDB1851-DU Flat
- UCDB1852-AL Radius
- UCDB1852-DU Radius
- UCDB1854-DU LH Bevel

**Narrow Stile Deadbolts**

Mortise Deadbolts Body Only, Less Strike & Faceplate



- UCDB28502 31/32" B.S.
- UCDB28503 1 1/8" B.S.

**Cam Plug Non Handed**



UCCP5560 Field Reversible

**Latch Lock Paddle Handle**

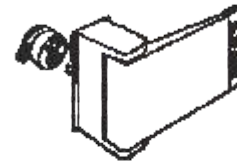

- "Push" or "Pull" Paddle Handle
- For use with DL4510 Type Latch
- Field reversible for opposite hand & "Push" or "Pull"
- Cam Plug, field reversible, included
- Extruded Aluminum Handle
- Finishes available: AL - Handle anodized Satin Alum., Housing baked Satin Alum. DU - Handle anodized Storefront Bronze Housing baked Storefront Bronze.

- UCPS591-LH-AL
- UCPS592-RH-AL
- UCPS593-LH-DU
- UCPS594-RH-DU

**MAGNET**



**SPECIFICATIONS**

- Surface Mounted
- Holding Force: 1200lbs
- Current Draw: 500mA/12V or 24VDC
- Field Selectable: 12V or 24VDC

UCML01-US28

**LEVER HANDLES**

**Latch Lock Lever Handle**

- For use with DL4510 type latch lock
- Cam plug non-handed & field reversible
- Finishes available
- AL - Baked Satin Aluminum Paint
- DU - Baked Storefront Bronze Paint
- Specify: Finish, Hand if pre-handing required



- UCL5561-LH-AL
- UCL5562-RH-AL
- UCL5563-LH-DU
- UCL5564-RH-DU

**ACCESSORIES**

- UC106 2100 Series Strike/Screw Kit
- UC68-5301 2100 Series Screw Pack Kit
- UC68-5913 x 626 2100 Series End Cap Assembly
- UCASSY-ED65R1 2100 Series Dogging Assembly



**EXIT DEVICES & TRIM**

**GRADE 1**



- UC2136-630 Rim Exit 36"
- UC2142-630 Rim Exit 42"
- UC203R-630 NL Pull Trim
- UC308R-626 Control Trim
- UC309R-626 Trim NL

**DOGGING KEYS**

Extra Long



- UC28410 5/32" Von Duprin
- UC28412 3/16" Corbin Russwin
- UC28414 7/32" Precision/VonDuprin



- UCUSBX6  
USCan Sex Bolt (6 Pack)

- UC68-5301 2100 Series Screw Pack Kit
- UC68-5913x626 2100 Series End Cap Assembly

**UC PB3602  
Touch Bar Exit Device**



- Economically priced, low profile panic exit device manufactured from wrought steel and painted in two durable finishes.
- For wood or aluminum doors
- Or if used on glass and aluminum doors requires minimum 6" stiles.
- Will work with Simplex 2015
- Non-Handed, Deadlatching, Hex dogging
- Meets 161 template requirement
- Quick and easy installation procedure
- Four outside trim accessories available separately.
- Minimum Stile 4 1/2"

- UCPB3602-ALUM-36 36"
- UCPB3602-DURO-36 36"
- UCPB4202-ALUM-42 42"
- UCPB4202-DURO-42 42"

**Keyed SC1 Lever Trim for PB Device**



LV006

- UCLV006-ALUM
- UCLV006-DURO
- UCKB005-630

- UCLV007-613
- UCLV007-630

☐ class room function



KB005

- Lever Trim ☐
- Lever Trim ☐
- Knob Trim ☐  
(PB3602/4202)
- Storeroom Exit Trim
- Storeroom Exit Trim



**NL Pull Plate**

- DP001
- 11.5" X 3"
- Cylinder Separate

- UCDP001-ALUM Round Pull
- IT54P3A-690 Cylinder Pull Plate NS

**ELECTRIC STRIKE/ELR KITS**



UCSGT78-630  
USCan Electric Strike



ITLR100ARK  
ELR Kit Adams Rite



ITLR100VDK  
ELR Kit Von Duprin

CAEDLP2-UL-M-KIT  
USCan 2100 Motor Drive Kit



**PADLOCKS**

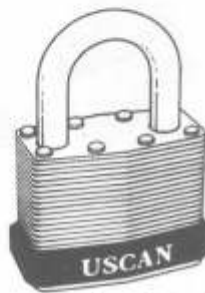

**UScan Quality  
Laminated Steel Padlocks**

Double locking hardened steel shackle. Solid brass pin tumbler cylinder. Galvanized laminated steel case. (M1) Keyway.

- UCL30-KA-KA1 7K 30mm wide
- UCL30-KA-KA2 7K 30mm wide
- UCL40-KD 7K 40mm wide
- UCL40-KA-KA1 7K 40mm wide
- UCL40-KA-KA2 1K 40mm wide
- UCL40-KA-KA5 1K 40mm wide
- UCL45-KA-KA1 1K 45mm wide
- UCL45-KA-KA2 1K 45mm wide
- UCL45-KA-KA3 1K 45mm wide



**Stainless Steel Round Padlock**

- 2 3/4" Diameter stainless steel interior and exterior body.
- Solid brass 4 pin cylinder with brass pins.
- Case hardened 13/32" diameter shackle.

- UCR70-KA1
- UCR70-KA3
- UCR70-KD
- UCR70-KB Keyblank R70 Series

**KEY BLANKS**

UC01007LA	UK S22 KEY BLANK SARGENT	UC1503	UK ES9 KEY BLANK ESP
UC01122	UKY11 KEY BLANK YALE	UC999	UK Y1-BLANK KEY - YALE 8
UC01122A	UKY12 KEY BLANK YALE	UCA1001EH	UK CO88 CORBIN KEY BLANK
UC01122AR	UKY14 KEY BLANK YALE	UCA1011D1	UK RU46 KEY BLANK RUSSWIN
UC01122B	UKY103 KEY BLANK YALE	UCA1145E	UK SC9 KEY BLANK SCHLAGE
UC01122R	UKY13 KEY BLANK YALE	UCA1176ST	UK KW10 KWIKSET/TITAN
UC1000V	UK CO26 KEY BLANK CCL	UCAR1-250	KB 1179 BX/250 K2 ARROW
UC1001EH	UK CO87-BLANK KEY-CORBIN	UCBK004	KEY BLANK USCAN/DIPLOMAT
UC1003M	UK HL1 KEY BLANK	UCD1054K	UK DE6 KEY BLANK DEXTER67
UC1004	UK L1 KEY BLANK LOCKWOOD	UCDE6-250	KB D1054K BX/250 67 DEXTR
UC1007LA	UK S22 1/2 KEY BLANK SARG	UCDPK003	KEY BLANK USCAN DRAWER
UC1011D1	UK RU45 KEY BLANK RUSS D1	UCHK1	UK HAWORTH
UC1011P	UK RU4-KEY BLANK-RUSSWIN	UCHK2	UK HAWORTH
UC1022	UK SE1 KEY BLANK SEGAL	UCHK3	UK HAWORTH
UC1028	UK DIE-3-NS KEY BLANK	UCHK4	UK HAWORTH
UC1028L	UK DIE-1-NS KEY BLANK	UCKW1-250	KB 1176 BX/250 1063KW
UC1028N	UK HHM-1-NS KEY BLANK	UCL1054B	UK IN8 KEY BLANK
UC1041H	UK IL1 KEY BLANK ILLINOIS	UCL1054G	UK L54G KEY BLANK FORT
UC1041T	UK CG16 KEY BLANK CHICAGO	UCL4-6-NS	UK SILVERLINE KEY BLANK
UC1041Y	UK KP1-BLANK KEY CHICAGO	UCLV007-613	STOREROOM EXIT TRIM SC1 KWY
UC1054FN	UK IN28-BLANK KEY - ILCO	UCLV007-630	STOREROOM EXIT TRIM SC1 KWY
UC1054MT	UK IN33-BLANK KEY	UCM1-250	KB 1092 BX/250 1K MASTER
UC1054WB	UK WR3-BLANK KEY - WEISER	UCN1054WB	UK WR5 KEY BLANK WEISER
UC1069L	UK NA14-BLANK KEY - NATNL	UCP1098A	UK B48 KEY BLANK GM"A"
UC1069LB	UK NA12-BLANK KEY - NATNL	UCP1098C	UK B50 KEY BLANK GM"C"
UC1069N	UK D8785-BLANK KEY NATL	UCP1098E	UK B44 KEY BLANK GM"E"
UC1092	UK M1-BLANK KEY-MASTER 1K	UCP1098J	UK B46 KEY BLANK GM"J"
UC1092B	UK M2 BLANK KEY MASTER 7K	UCP1770U	UK Y152 KEY BLANK CHR IGN
UC1098M	UK B1-NP-BLANK KEY	UCR1003M	UK HL2 KEY BLANK HUDSON
UC1115	UK MOS-3-NS KEY BLANK	UCR1064E	UK NA6 KEY BLANK NATIONAL
UC1123	UK WE1-BLANK KEY	UCS1000V	UK CO68 KEY BLANK CCL
UC1137B	UK 137B-BLANK KEY ACE BRS	UCS1098B	UK B49 KEY BLANK GM"B"
UC1137S	UK 137S-BLANK KEY ACE	UCS1098D	UK B51 KEY BLANK GM"D"
UC1141GE	UK T7-BLANK KEY - TAYLOR	UCS1098H	UK B45 KEY BLANK GM"TH"
UC1145	UK SC1-BLANK KEY-SCHLAGE	UCS1098K	UK B47 KEY BLANK GM"K"
UC1145A	UK SC4-BLANK KEY-SCHLAGE	UCS1167FD	UK H50 KEY BLANK FORD SEC
UC1145E	UK SC8-BLANK KEY-SCHLAGE	UCSC1-250	KB 1145 BX/250 100C SCHL
UC1167FD	UK H51 KEY BLANK FORD IGN	UCSC4-250	KB 1145A BX/250 101C SC
UC1175N	UK WK2 KEY BLANK WESLOCK	UCSC9-250	KB A1145E BX/250 101E SC
UC1176	UK KW1-BLANK KEY-KWIKSET	UCSE1-250	KB 1022 BX/250 SEGAL
UC1179	UK AR1 KEY BLANK ARROW	UCWK2-250	KB 1175N BX/250 12344
UC1179A	UK AR4 KEY BLANK ARROW	UCWR3-250	KB 1054WB BX/250 1555 W
UC1180S	UK XL7-BLANK KEY	UCWR5-250	KB N1054WB BX/250 P1555
UC1184FD	UK H54 KEY BLANK FORD IGN	UCX1014F	UK EA27 KEY BLANK EAGLE
UC1270D	UK T146-BLANK KEY	UCX1054K	UK IN3 KEY BLANK
UC1307A	UK SC6 KEY BLANK SCHLAGE	UCY1-250	KB 999 BX/250 YALE 8
UC1502	UK ES8 KEY BLANK ESP	UCY11-250	KB 01122 BX/250 YALE11
UC1502M	UK ES8M KEY BLANK ESP		



Electronic access control  
and mechanical locks



Exit devices



Door closers and auto operators

The premier brands that make up Allegion have been revolutionizing safety and security products for more than 100 years. Today, Allegion has built upon their pioneering spirit. We are at the leading edge of the convergence of technologies, enhancing our mechanical, electronic and cloud technology offerings.

Specializing in security solutions around the door, we stand behind every product we make with unparalleled service and support. It's our commitment to design, performance and innovation that ensures you can stand by our products too.

Build your business with the brands you know and trust. Allegion has the portfolio of solutions to help you grow. Visit [us.allegion.com](http://us.allegion.com).



DEVICES & TRIMS

22 SERIES RIM EXIT DEVICE



- Features:
- Nonhanded
  - Field sizeable
  - Min. stile/22EO 3 3/4"
  - Min. stile/227EO 3 3/8"

VD22EO-SP28-36	Rim
VD22EO-F-SP28-36	Fire
VD22EO-SP28-48	Rim
VD22EO-SP313-36	Rim
VD22EO-F-SP313-36	Fire
VD227EO-SP28-36	Surface Vert Rod
VD227EO-SP313-36	Surface Vert Rod

22 SERIES TRIMS



210K

VD210K-SP28	Knob
VD210K-SP313	Knob
VD210NL-SP28	Pull
VD210NL-SP313	Pull
VD230NL-SP28	Pull
VD230NL-SP313	Pull
VD230L-SP28-LHRB	Lever
VD230L-SP28-RHRB	Lever
VD230L-SP313-LHRB	Lever
VD230L-SP313-RHRB	Lever

33A SERIES RIM EXIT DEVICE

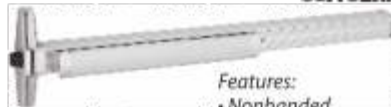

- Features:
- Nonhanded
  - Fits 2' 4" to 3" doors
  - Min stile 1 3/4"

VD33A-EO-US28-3	Exit Only
VD33A-EO-313-3	Exit Only
VD33A-NL-OP-US28-3	Night Latch/Cylinder



33A SERIES TRIMS

- Key retracts latchbolt  
Optional Pull Required
- VD388-US26D
  - VD388-US10B

88 SERIES RIM EXIT DEVICE



- Features:
- Nonhanded
  - Field sizeable
- VD88EO-26D-42 Exit Only



88 SERIES TRIMS

- Key Unlocks Thumbpiece
- VD880TPR-26D

99 SERIES RIM EXIT DEVICE

- Features:
- Nonhanded
  - Field sizeable
  - Min. stile/99EO 4 1/2"
  - Min. stile/9927EO 3 3/4". Std. strike 299



VD99EO-26D-36	Rim
VD99EO-28-36	Rim
VD99EO-28-48	Rim
VD99EO-313-36	Rim
VD99EO-F-26D-36	Rim Fire
VD9927EO-US28-36	Surface Vert Rod
VD9927EO-313-36	Surface Vert Rod



99 SERIES TRIMS

- Key Retracts Latch
- VD990NL-R/V-10B
  - VD990NL-R/V-26D

- Key Locks Lever
- VD996L-R/V-LHR-26D
  - VD996L-R/V-RHR-26D



- Key Retracts Latch - Break Away
- VD996L-NL-R/V-LHR-26D
  - VD996L-NL-R/V-RHR-26D

- Dummy Trim
- VD990DT-US26D
  - Key Unlocks Thumbpiece
  - VD990TP-R/V-26D

Guard X Exit Alarm



- Features:
- Nonhanded
  - 2" x 1/2" stainless steel bolt with 3/8" throw
  - Uses standard rim cylinder to arm & disarm lock
  - Armed indicator light
  - Fits 36" to 48" doors
  - 9-volt battery powers alarm
  - UL Listed for panic hardware

VD2670-US28  
VD2670-313

ELECTRIC STRIKES

4200 SERIES

- Features:
- Designed for cylindrical applications
  - Capable of four in-field configurations
  - Shallow 1 3/8" backbox depth
  - Field selectable 12/24 VDC voltage
  - Non-handed, internal solenoid design
  - Low current draw for PoE installations
  - Field selectable power failure mode (fail-safe/fail-secure) without disassembly

VD4211-US32D  
VD4212-US32D



## ELECTRIC STRIKES — continued

### 5100 SERIES



Standard ANSI,  
Sharp Corner

- VD5100-3FP-622 Lacquer Sprayed Black
- VD5100-3FP-689 Lacquer Sprayed Aluminum
- VD5100-3FP-695 Sprayed Duranodic

### 6111 SERIES

Use with rim exit devices

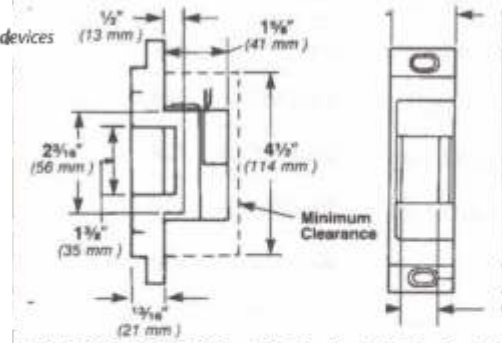

- VD6111-12VDC-32D
- VD6111-24VDC-32D

**FAIL SECURE**

### 6112 SERIES

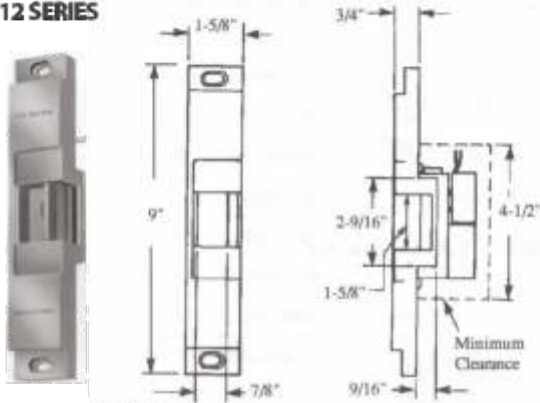

- Use with rim exit devices
- Designed to replace Folger Adam 310-4, minor frame prep required

- VD6112-12VDC-32D
- VD6112-24VDC-32D

### 6113 SERIES

Use with rim exit devices

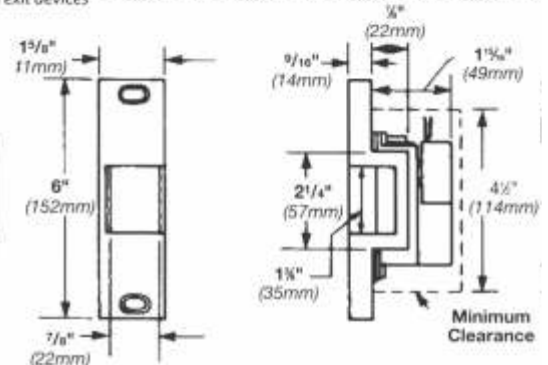

- VD6113-12VDC-32D
- VD6113-24VDC-32D

**FAIL SECURE**

### 6210 SERIES

- Use with mortise locks without deadbolt
- Pocket inserts provided to accommodate different manufacturers deadlocking trigger locations

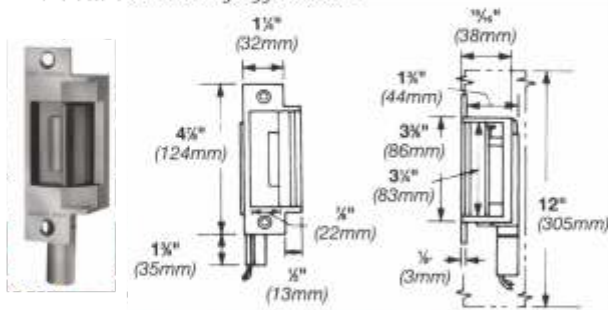

- VD6210-12VDC-32D
- VD6210-24VDC-32D

### 6211 SERIES

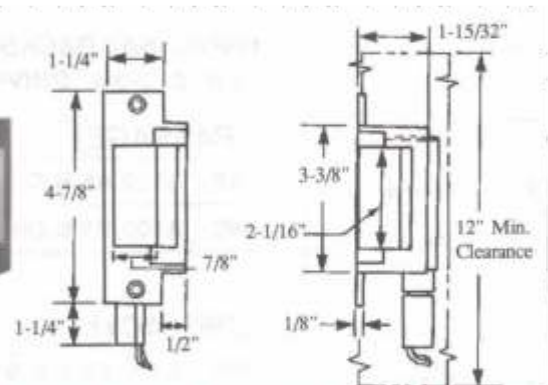

- Use with mortise locks without deadbolt or cylindrical locks
- Designed to replace Folger Adam 712

- VD6211-12VDC-32D
- VD6211-24VDC-32D

**ELECTRIC STRIKES** — *continued*

**6211WF SERIES**



- Use with mortise locks without deadbolt or cylindrical locks wood frame applications
- Designed to replace Folger Adam 732

VD6211WF-24VDC-32D

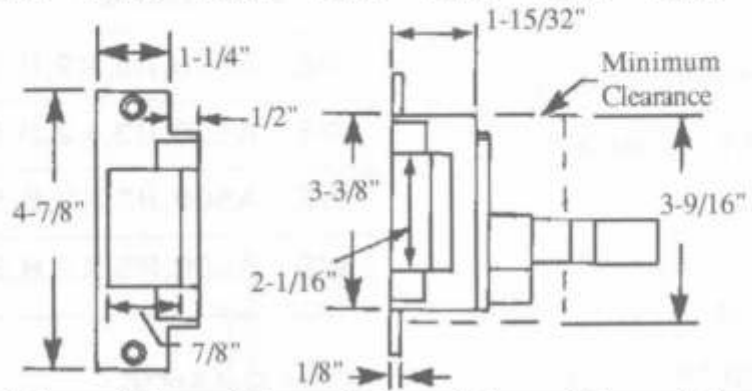

**6212 SERIES**

- Use with mortise locks without deadbolt or cylindrical locks



VD6212-24VDC-32D

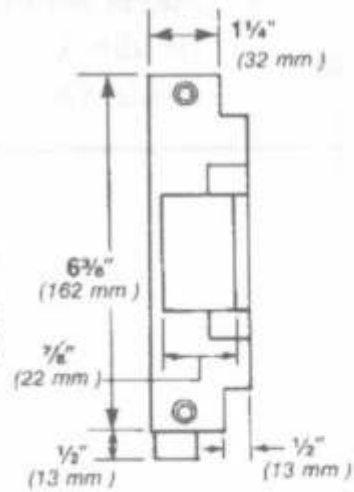
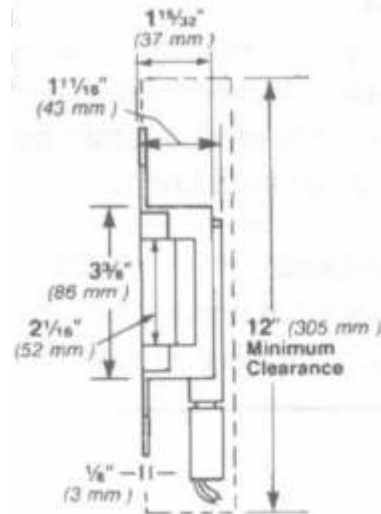

**6215 SERIES**

- Use with mortise locks without deadbolt or cylindrical locks
- Designed to replace Folger Adam 310-2

VD6215-12VDC-32D  
VD6215-24VDC-32D

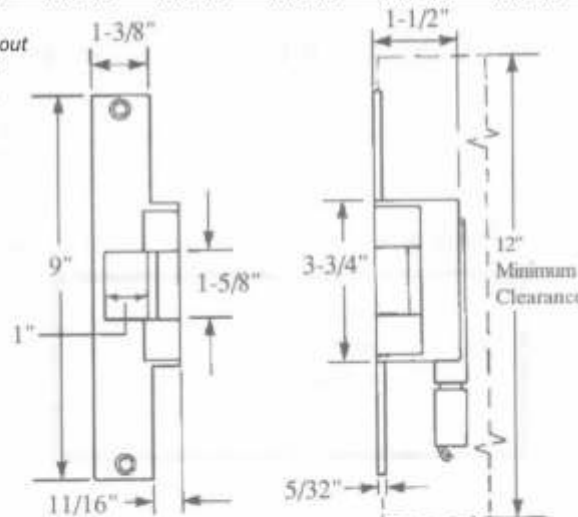

**6300 SERIES**

- Use with the Von Duprin 98/99

VD6300-US32D



**6400 SERIES**



- Field selectable voltage 12 VDC or 24VDC and 12 to 24 VAC
- Fail secure only
- Non-handed
- Fire-Rated

VD6400-US32D  
Mort Electric Strike





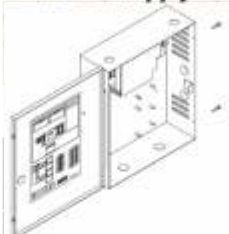









## MISCELLANEOUS HARDWARE

<p><b>Power Supply</b></p>  <ul style="list-style-type: none"> <li>• 4 amp, high inrush @ 12/24V</li> <li>• For 1-2 EL Exit Devices, P5914 with a 900-2RS Board installed</li> </ul> <p>VDPS902-ZRS Power Supply For 1-2 QEL          VDPS914 Power Supply Base          VDPS914-2RS Base W/900-2RS</p>	<p><b>Electric Power Transfer</b></p>  <ul style="list-style-type: none"> <li>• Two 18 gauge wires, rating 24VDC 2 amp, 16 • Ten 24 gauge wires, amp maximum surge rating: 24VDC, 1 amp</li> </ul> <p>VDEPT2-SP28          VDEPT2-SP313          VDEPT10-SP28</p>	<p><b>Rectifier</b></p>  <ul style="list-style-type: none"> <li>• Converts AC voltage to operate the DC solenoids.</li> <li>• They are field installable and plug in-line to solenoid.</li> </ul> <p>VDSO-24 24 Volt</p>
--	---	---

## PARTS

<p><b>Conversion Kits</b></p>  <p>88CK-NL</p> <ul style="list-style-type: none"> <li>VD050101-26 88CK-NL</li> <li>VD050114-US28 99 HEX DOG</li> <li>VD050115-US28 99 Cylinder Dogging</li> <li>VD050115-710 99 Cylinder Dogging</li> </ul>	<p><b>1/4" Lift</b>          for Rim / Mortise          98/99 Series</p>  <p>Use on doors with raised glass beads</p> <p>VD99GBK-R/M-SP28          VD99GBK-R/M-SP313</p>	<p><b>2 Relay Board</b></p>  <p>VD900-2RS</p>	
<p><b>Strike</b></p> <ul style="list-style-type: none"> <li>• Black, Nylon</li> <li>• For Rim/vertical Rod Application</li> <li>• Projection 13/16"</li> </ul>  <p>2 7/8"</p> <p>1 1/4"</p> <p>VD299-US19          VD299F-US19 Fire Strike</p>	<p><b>Strike</b></p> <ul style="list-style-type: none"> <li>• Black, Nylon</li> </ul> <p>VD1609</p>  <p>3 1/4"</p> <p>1 7/8"</p>	<p><b>Blade Stop Shim</b></p>  <p>VD010055-689</p>	<p><b>Old Style Hex Dogging Kit</b>          98/99 Before 08/97</p>  <p>VD050709-00</p>
<p><b>6000 Strike Spring Kit</b></p>  <p>VD050939-00 6211/AL/WF 6212/WF          VD050940-00 6210          VD050942-00 6111 6113 6213 6221 6223          VD050943-00 6112/14/21 6214/15 6222</p>	<p><b>Alarm Kits</b></p>  <p>22-ALK 99-ALK</p> <p><b>Features:</b></p> <ul style="list-style-type: none"> <li>• Uses 1 1/4" mortise cylinder</li> <li>• Operates on 1 standard 9-volt battery</li> <li>• Alarm kit monitors the touchpad and is furnished standard</li> <li>• Includes "EMERGENCY EXIT ONLY ALARM WILL SOUND" decal</li> </ul> <p>VD99-ALK-28-3'</p>	<p><b>End Cap Kit</b>          US26D 33A / 35A          98/99 Series</p>  <p>VD050014-26 US26D          VD050014-689 US28          VD050014-695 313AN</p>	

**PARTS — continued**

**Centercase/End Case Parts**



VD034302-32  
Sex Bolts/#425-US32D (2pkg) 10-24 thread



VD050020-00  
99 Rim Center Case Kit



VD050071-26  
98/99-F Center Case Cover Kit



VD090052-00  
55 End Case Spring



VD090053-00  
Screw, Dogging #55 device



VD090083-89  
Screw, Dogging #88 device



VD090085-89  
Key Dogging 227 5/32" / 88&99 device



VD090079-00  
99 Latchbolt Pin



VD090074-00  
NL Drive Screw

**Service Replacement Items**



VD091031-00  
Spring-Gravity Dog



VD091080-00  
Key-Dogging 222 7/32"

**Mortise Lock**



VD 7500-US32D

**Packaged 22 33A/35A**



VD090040-00  
Hex Dogging Shaft



VD090041-00  
Dogging Spring



VD090042-00  
Dogging Adapter Spring



VD090043-00  
Dogging Adapter Spring



VD090044-00  
Dogging Hook



VD090046-00  
CD Dogging Plug

**Fasteners/Screw Packs**



VD900620-00  
9947 Rod Adjusting Screw Pkg



VD900850-26  
22/9927 Latch Cover Screws  
-US32D



VD900892-32  
99 Center Case Screw Pkg  
-US32D



VD900901-32  
End Cap Screw Pack  
-US32D

**Electrical Components**



VD050070-00  
3' EL Conversion Kit,  
Series 33/35 & 98/99



VD050078-00  
4' EL Conversion Kit,  
Series 33/35 & 98/99



VD114317-00  
QEL Modular Conversion Kit

VD114320  
Qel Cable Pack

VD040086-00  
Chexit PCB Kit After 8/17/2015



VD050251-00  
RX Switch Kit



VD050534-00  
EL Potted Module



VD050536-00  
EL Solenoid & Connector Assy  
(Jan '87 - July '99)



VD050535-00  
EL Solenoid & Plunger Assy,  
L-Bracket Mount (from July 1999)



VD970388-77  
FSE Slider - 6211, 621200F & 6221,  
6223 only FAIL SAFE



VD970387-77  
FSE Slider

**Mechanism Case/End Cap**



VD050491-00  
Shock Absorber/Holder Assy



VD900981-00  
22 End Cap/Bracket



VD968595689  
22 Cover Plate-SP28

VD050589-US28  
99 Less Dogging Cover Plate

## PARTS — continued

### Vertical Latch/Rod Components



VD034902695  
Sex Bolts #325-SP313  
(2/pkg) 1/4-20 Thread



VD050400-00  
22/33A/9927 Top Latch Kit



VD050401-00  
22/33A/9927 Bottom Latch Kit



VD050460-00  
8827 Top Latch



VD050493-00  
99/3347 Bottom Latch



VD106222689  
Ratchet Release Assy-SP28



VD050402-00  
99/2227 Pullman Latch



VD050492-00  
99/3347 Top Latch



VD050464-26  
8827 Top Latch Connector



VD050566-26  
9927 Latch Cover-US26D

VD24090110  
9949 Top Latch Assembly



VD4954 BLANK SP28 7-2  
Blank Mullion Up to 72"  
VD4954 BLANK SP313 7-2  
Blank Mullion Up to 72"

### Lever Arms/Crossbar Parts



VD050438-26  
88 Lever Arm RH-US26D



VD050439-26  
88 Lever Arm LH-US26D



VD090020-00  
Crossbar Wedge (2/Pkg)



VD090081-89  
Screw- Wedgetite



VD090082  
88 Lever Arm Axle



VD103865-00  
Axle Pack



VD154-SP28 Mullion Stabilizer



VD154-SP313 Mullion Stabilizer

### Trim/Control Parts



VD050148-00  
230L Shearpin Repl Kit (10/pkg)



VD050156-00  
Tailpiece Guide (10/pkg)



VD050611-00  
Shear Pin



VD109111-00  
370 Cylinder Lock Nut/Washer



VD050599-00  
370 NL Plate



VD968201-89  
Cylinder Cup



VD971440-89  
991K/992L Hex Stud



VD971573-00  
992 Lift Spring



VD090107-00  
Control Link Pin Ret Ring PKG/10

VD971585-89  
HEX STUD 994/996 TRIM

VD24090110  
9949 Top Latch Assembly



**WELCOME HOME SERIES**

**Deadbolts**

- WEGD9471-X5-WS-B-DIR2
- WEGD9471-X5-WS-B-SLS2
- WEGD9471-X26D-WS-B-DIR2
- WEGD9471-X26D-WS-B-SLS2
- WEGD9471-X3BR-WS-B-DIR2
- WEGD9471-X3BR-WS-B-SLS2



**ELEMENT SERIES**



**Deadbolts**

- WEGDC9471-5-K2WS-B-SLS2
- WEGDC9471-26D-K2WS-B-SLS2
- WEGDC9471-3BR-K2WS-B-SLS2



**Beverly Knobs**

- WEGAC531-B-5-K3WS-B-6LR1
- WEGAC531-B-3-K3WS-B-6LR1
- WEGAC531-B-26D-K3WS-B-6LR1

**TOOLS**

**Cylinder Cap Tool**

WEW1029



**KEYS**

**Brass Key Blank**

WEW1555 50/Box





Yale Commercial Solutions



nexTouch™

**Unlock  
what's next**  
for more choice in  
more applications

Visit [yalelocks.com/nexTouch](http://yalelocks.com/nexTouch)  
for more information.

With all of the features you love about the original cylindrical nexTouch™ Keypad Lock, the **nexTouch Sectional Mortise Keypad Lock** opens the platform to even more applications. Great for new construction or retrofit opportunities, the **ANSI/BHMA Grade 1 certified** nexTouch Sectional Mortise Keypad Lock provides **robust security** to any office, retail store, or multi-family building.

For a dependable, affordable keypad lock for all your commercial applications, **Yale Works for You<sup>SM</sup>**.

Copyright © 2018, ASSA ABLOY Access and Egress Hardware Group, Inc. All rights reserved. Reproduction in whole or in part without the express written permission of ASSA ABLOY Access and Egress Hardware Group, Inc. is prohibited.

An ASSA ABLOY Group brand

**ASSA ABLOY**

## ELECTRONIC LOCK

**NexTOUCH TOUCHSCREEN**

YAAU-NTB610-NR-2803-53L-626	<i>NexTOUCH PUSHBUTTON KR</i>
YABAU-NTB620-NR-LessCyl-626	<i>NexTOUCH TOUCHSCREEN SFIC PREP</i>
YAMAU-NTB620-NR-LessCyl-613E	<i>NexTOUCH TOUCHSCREEN MED/ASSA</i>
YAMAU-NTB620-NR-LessCyl-626	<i>NexTOUCH TOUCHSCREEN MED/ASSA</i>
YAAU-NTB620-NR-2803-53L-613E	<i>NexTOUCH TOUCHSCREEN KR</i>
YAAU-NTB620-NR-2803-53L-626	<i>NexTOUCH TOUCHSCREEN KR</i>
YAAU-NTB630-NR-626	<i>NexTOUCH PUSHBUTTON KEYPAD</i>
YAHA2	<i>RADIO MODULE HA1.2 ZIGBEE</i>
YASIAU-NTB620-NR-LessCyl-626	<i>NexTOUCH TOUCHSCREEN SCH LFIC</i>
YAZW2	<i>RADIO MODULE USA ZWAVE</i>
YAAUR-NTM610-626	<i>NexTOUCH PUSHBUTTON MORTISE</i>
YAAUR-NTM620-626	<i>NexTOUCH TOUCHSCREEN MORTISE</i>
YRYRD426-NR-619	<i>TOUCHSCREEN BLUETOOTH DEADBOLT</i>
YRYRL220NR-619SC	<i>TOUCHSCREEN LEVER LOCK SC1 KWY</i>

## BOLT & LATCH LOCKS

**Heavy Duty Surface Mounted Bolt Lock**

*Features:*

- Key outside, thumbturn inside, two hardened steel interlocking bolts
- Door Thickness: 1 3/8" to 2 3/4"
- Cylinders: Brass, with 2 keys
- 4 3/4" wide, 3 1/2"
- Backset: 2 3/8"

YA197      Single Cylinder  
YA197-1/4      Double Cylinder

**Surface Mounted Deadbolt**

*Features:*

- Backset: 2 3/8"
- Deadbolt: 1 1/8" throw, two hardened steel inserts
- Door Thickness: 1 3/8" to 2 3/8"

YA112      Single Cylinder

**Replacement Strike**

YA197-F-STRIKE

**Surface Mounted Latch Lock**

*Features:*

- Latchbolt held retracted or deadlocked by button
- Door Thickness: 1 3/8" to 2 1/8"
- Case: 3 3/8" wide, 2 1/2" high
- Backset: 2 3/8"

YA80      Latchlock

## EXIT DEVICE

YA6100-36-630      RIM EXIT DEVICE 36"



**5400 SERIES — GRADE 1**



AU

**Features:**

- Mounting plate for chassis stability
- Meets and exceeds ANSI torque test
- 1/2" latchbolt projection
- Independent lever return springs

**Entrance, Office, Corridor**

YAAU5407LN-626

YAPB5407LN-626



PB

**Privacy**

YAAU5402LN-626

**Classroom**

YAAU5408LN-626

**Passage**

YAAU5401LN-626

**Storeroom**

YAAU5405LN-626

YAAU5405LN-LC-626

**CYLINDERS**

**5400 Series**

YA1802-PARA-US26D-KR



Use in knob by removing tailpiece

**200 Series**

YRAYRD200-SCKD-03

YRAYRD200-SCKD-26



**Mortise**

YA1152-1-1/8-26D

PARA KD

YA1152-1-1/8-GA-26D

GA '0' Blitted





**DOOR VIEWER**



**Look Door Viewer w/Wi™**

YRYRV740W1693

**CYLINDER SHELLS & PLUGS**

 <p>Rim</p>	<p><b>Shells</b></p>  <p>Knob Mortise</p>		<p><b>Rim Cylinder Plugs</b>          YAGA-6P-26D          YAGB-6P-26D          YAGC-6P-26D          YAGD-6P-26D          YAGF-6P-26D</p>
<p>YA1109-6-10          YA1109-6-26D          YA1109SHL-626-6          YA1152HSG-626-118          YA1802-SHELL          YA1210-626-GG-6          YA1210-626-GA-6          YA1210-626-PARA-6</p>	<p>Rim          Rim          Rim 6-Pin          Mortise          Knob          LFIC 6-Pin 0-Bitted          LFIC 6-Pin 0-Bitted          Control Blank EIR(PARA)</p>	<p><b>Mortise Cylinder Plugs</b>          YAGA-6P-1-1/8-26D          YAGB-6P-1-1/8-26D          YAGC-6P-1-1/8-26D          YAGD-6P-1-1/8-26D          YAGE-6P-1-1/8-26D          YAGG-6P-1-1/8-26D          YAGH-6P-1-1/8-26D</p>	<p><b>Knob Cylinder Plugs</b>          YA1802PLG-626-GA-6          YA1802PLG-626-GB-6          YA1802PLG-626-GC-6          YA1802PLG-626-GD-6          YA1802PLG-626-GE-6          YA1802PLG-626-GF-6          YA1802PLG-626-GG-6</p>

**CYLINDER ACCESSORIES**

**Cylinder Adapter Kit**



Schlage Cylinder Adaptor Kit  
YA107S

**Cylinder Rings**  
YAKP4-626



**5300 Series Deadlatch**

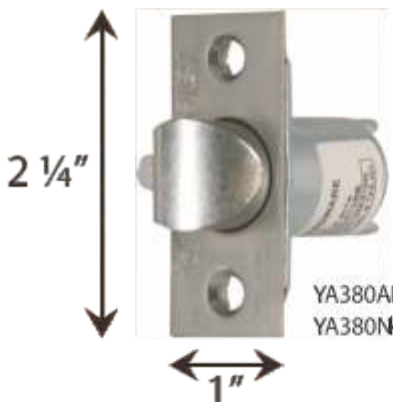

2 1/4"  
1"

YA380AN-26D 2 3/8"  
YA380N-26D 2 3/8"

**5400 Series Deadlatch**

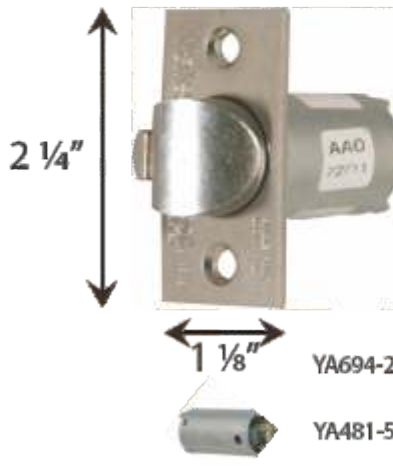

2 1/4"  
1 1/8"

YA694-26D 2 3/4"  
YA481-5 Extension Link

### PARTS



YA2160 LFIC Cam for 87/  
8800 Mortise Lock



**Cams**  
YA1161 Standard



YA1161L MS/AR

#### Miscellaneous Parts



YA1145 Connecting Bar (Regular)



YA1147 Connecting Bar (Long)



YA1151 Connecting Screw



YA1178L Spindle, Lever Trim



YA1451 Retainer, 1109



YA9999-4561 Plug Retainer



YA34-0010-1015-059 Backplate, Rim Cyl



YA50-4605-0035-048 Cyl Clamp Assy



YA10-6120-0009 Disc, Cam



YA60-7000-1224-999 Torsion SpringRH



YA60-7000-1225-999 Torsion SpringLH



YA81-0611-0154-036 Cam Screw (Mortise Cyl)



YA14-5401-1641-999 Outside of set



YA14-5401-1642-999 Inside of set

#### Blanks

YAFN117C CONTROL BLANK GA KEYWAY  
 YAFN117C-GA CONTROL BLANK GB KEYWAY  
 YAFN117C-GB CONTROL BLANK GC KEYWAY  
 YAFN117C-GC KEY BLANK  
 YAPARARN9 KEY BLANK E1R (PARA) NS  
 YARN11 KEY BLANK 7PIN E1R (PARA)  
 YARN117 KEY BLANK  
 YARN11GA KEY BLANK  
 YARN11GB KEY BLANK  
 YARN11GC KEY BLANK  
 YARN11GD KEY BLANK

YARN11GE KEY BLANK  
 YARN11GF KEY BLANK  
 YARN11GG KEY BLANK  
 YARN11GH KEY BLANK  
 YARN11GK KEY BLANK "G" FITS  
 YARN11GMK GA-GH  
 YARN11GST KEY BLANK FITS G-S-T  
 YARN11SA KEY BLANK  
 YARN11SB KEY BLANK  
 YARN11SC KEY BLANK  
 YARN11SD KEY BLANK

YARN11SE KEY BLANK  
 YARN11SF KEY BLANK  
 YARN11SG KEY BLANK  
 YARN11SH KEY BLANK  
 YARN11SMK KEY BLANK  
 YARN8 KEY BLANK E1R (PARA) NS

### YOUNG BROTHERS



#### Stamps

##### 1/16" 2 Line Stamps

YB01 DNC Do Not Copy  
 YB01 DND Do Not Duplicate

##### 3/32" 2 Line Stamps

YB02 DNC Do Not Copy  
 YB02 DND Do Not Duplicate  
 YB02 MASTER Master

##### Figures

YB02091 3/32" Figures  
 YB03091 1/8" Figures  
 YB05091 3/16" Figures

##### Letters

YB02271 3/32" Letters  
 YB03271 1/8" Letters  
 YB05271 3/16" Letters





## Master Lock Safety Solution



**Master Lockout Hasps**



**Master Osha Safety Padlocks**



**Master Group Lockout**



**Master Lockout Stations**



**Osha Group Lock Boxes**



**Master Lockout Kit**



**Master Guardian  
Tags**



**Removable Push Button  
& Rotary Switch Cover**



**Adjustable Butterfly  
Valve Lockout**



# DOORJAK

## Door Installation Cart



### DoorJak 50

#### Sturdy, Portable Door Installation Cart



The DoorJak 50 is a lighter weight, more portable door hanging cart. At 66lbs, it makes swift work of smaller door installation jobs holding doors up to 250lbs.

### DoorJak 100

#### Heavy Duty, Portable Door Installation Jacks



The DoorJak 100 is the original door installation cart. It allows one man to safely remove, transport and rehang heavy, oversized commercial grade doors up to 750lbs.

# **FBI** FRIED BROTHERS, INC.

ESTABLISHED 1922

SUPPLIER OF DOOR HARDWARE, SECURITY PRODUCTS, AND ACCESS CONTROL



[FBIssecurity.com](http://FBIssecurity.com)

**GSA Contract :** GS-07F-0249Y

**GSA Contract :** GS-07F-0326T

**DUNS NO :** 001949684

**CAGE CODE :** 40786

**Phone :** 215-627-3205

**Email :** [sales@fbisecurity.com](mailto:sales@fbisecurity.com)